

LODES

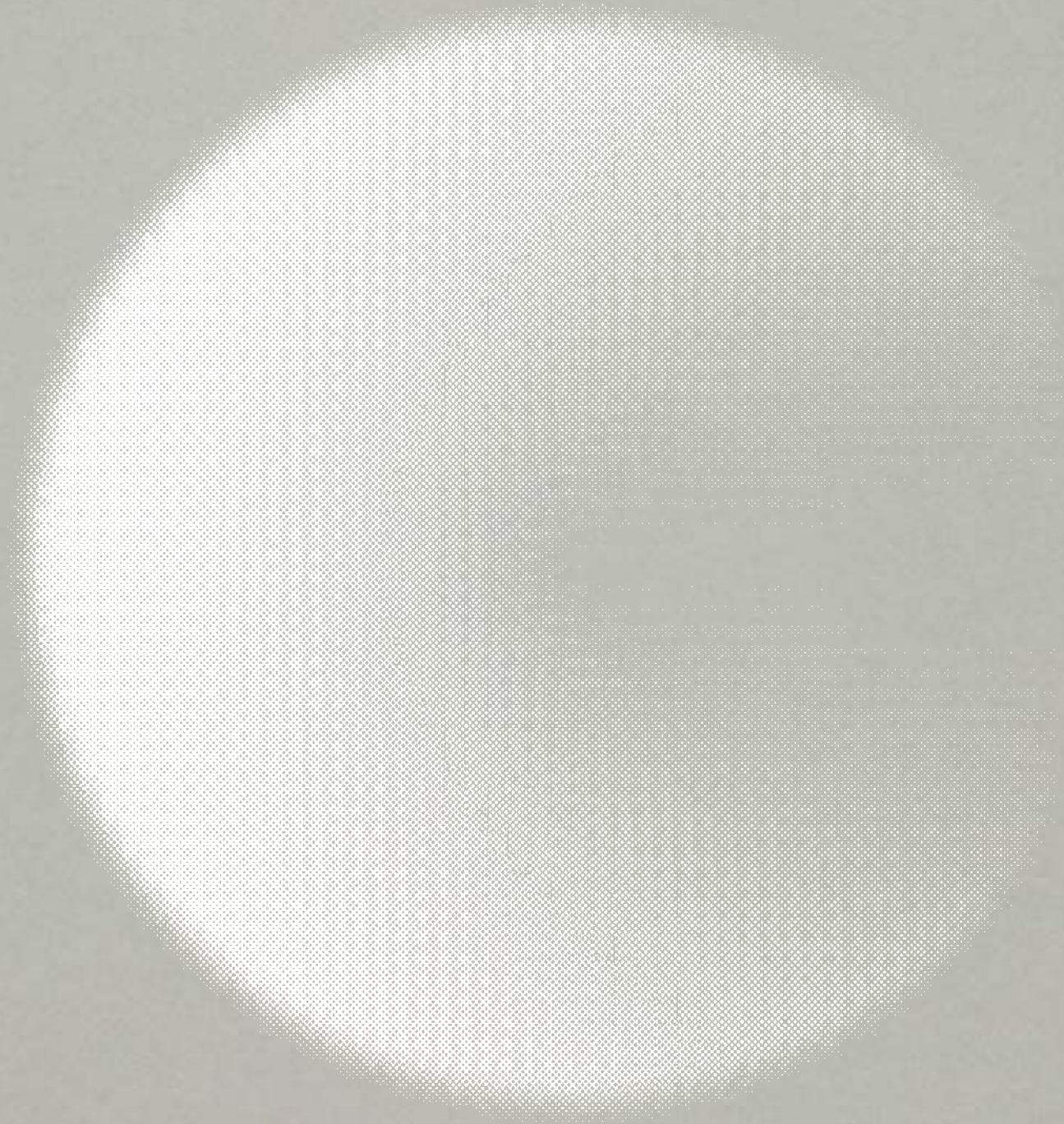

2022 Collection Catalogue

Pag.	Product name	Category
074	A A-Tube	Cluster suspension lamp, Ceiling lamp
046	A-Tube Nano	Cluster suspension lamp
064	A-Tube Nano Duo	Cluster suspension lamp
304	Aile	Wall lamp
260	B Blow	Table lamp
356	Bugia	Ceiling lamp
278	C Cima	Suspension lamp, Floor lamp
264	Croma	Floor lamp
250	E Easy Peasy	Cordless table lamp
240	F Flar	Table lamp, Floor lamp
386	Frozen	Ceiling lamp
026	I IVY I	Cluster suspension lamp
026	IVY V	Suspension lamp, Central cluster suspension lamp
204	J Jefferson	Cluster suspension lamp
140	JIM	Cluster suspension lamp, Suspension lamp
124	K Kelly	Suspension lamp, Wall lamp
114	Kelly Cluster	Cluster suspension lamp
374	L Laser	Wall lamp
380	M Make-Up	Wall lamp, Ceiling lamp
288	N Nautilus	Ceiling lamp, Wall lamp
288	Nautilus Mini	Wall lamp
214	Nostalgia	Cluster suspension lamp
368	P Pin-Up	Wall lamp, Ceiling lamp
340	Puzzle	Wall lamp, Ceiling lamp
312	Puzzle Mega	Wall lamp, Ceiling lamp
348	Puzzle Outdoor	Wall lamp
328	Puzzle Round	Wall lamp, Ceiling lamp
084	R Rain	Cluster suspension lamp
174	Random	Cluster suspension lamp
186	Random Solo	Cluster suspension lamp
228	S Sky-Fall	Suspension lamp
098	Spider	Cluster suspension lamp, Ceiling lamp
158	V Volum	Cluster suspension lamp, Suspension lamp

Lighting Makers from *Venice* since 1950

Lodes – Standard tools, bespoke solutions

Lodes has been designing and producing lighting solutions for interiors and exteriors since 1950. Based in Venice, the brand fuses contemporary design and innovative technology, using materials of the highest quality, to deliver premium lighting that prioritise the relationship with the end user. Lighting that suits most needs and moods – efficient and powerful proprietary LED modules as well as versatile standard light sources.



002



003



004



001

Lodes – Strumenti universali per soluzioni personalizzate

Lodes progetta e produce soluzioni illuminotecniche d'arredo d'interni ed esterni dal 1950. Coniugando design contemporaneo e tecnologia di punta, l'azienda veneziana utilizza materiali di altissima qualità per sviluppare soluzioni illuminotecniche di eccellenza che privilegiano l'interazione con l'utente finale. I prodotti Lodes sono in grado di soddisfare ogni esigenza e mood d'arredo anche grazie a esclusivi moduli LED efficienti e potenti e a fonti luminose standard particolarmente versatili.

001 Headquarters Marcon, Venice
002 Andrea Tosetto, President
003 Massimiliano Tosetto, General Manager
004 Warehouse Marcon, Venice

MASTERY

Originating in founder Angelo Tosetto's passion for glass, Lodes represents a three-generation evolution from pure passion to brilliant lighting solutions. Today, Lodes favours durable materials that can be moulded at will, to suit specific design visions and best serve each project. Glass and metal celebrate the company's manufacturing know-how and its high-quality *Made in Italy* essence.

MAESTRIA

Nata dalla passione per il vetro del fondatore Angelo Tosetto, Lodes racconta un percorso evolutivo attraverso tre generazioni, dalla pura passione alle soluzioni illuminotecniche più originali. L'azienda veneziana opta per materiali durevoli da plasmare a piacimento in funzione delle specifiche esigenze di design di ogni singolo progetto. È così che il vetro e il metallo celebrano il know-how produttivo e la qualità *Made in Italy* di Lodes.



007



008

005-6 Metal manufacturing know-how
007-8-9 Glass manufacturing know-how



005



006



009

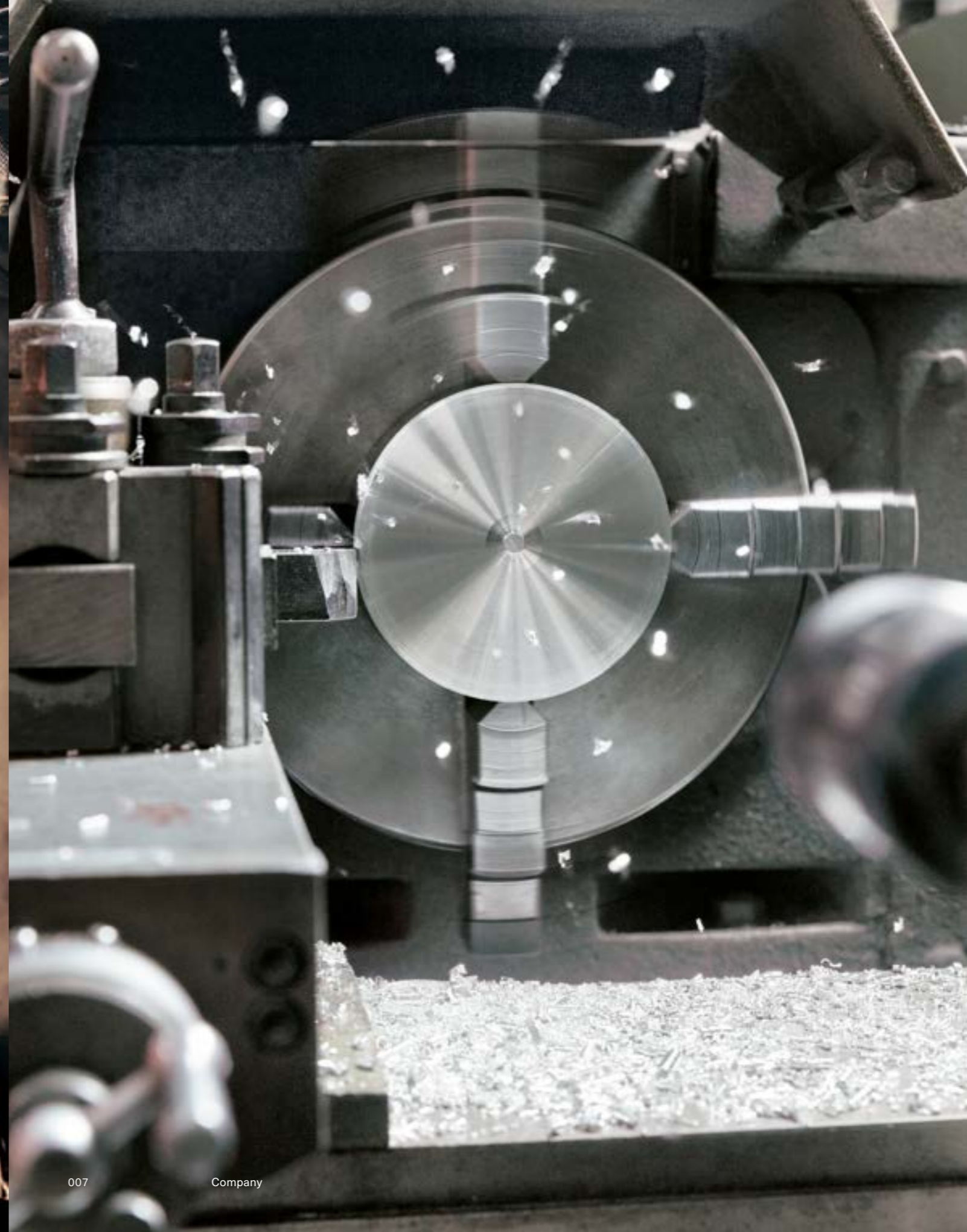



Canopy Systems

A. 1	Single Mini	032
		050
		146
		194
A. 2	Recessed Micro	034
		048
		058
		092
		107
		162
		163
		181
		192
		220
A. 3	Single Standard	
A. 4	Wall Standard	223

The freedom offered by Lodes' canopies brings to life the concept of "standard bespoke" which characterises the collection, a selection of products which are universal yet particular to each client's needs. Smart functional solutions as well as stand-out decorative elements, canopies provide an array of possibilities to personalise any living spaces, whether residential or public.

La libertà offerta dai rosoni Lodes dà vita al concetto di "standard su misura" che contraddistingue la collezione: una selezione di prodotti che, nonostante il carattere universale, rispondono alle esigenze specifiche di ogni cliente. I rosoni Lodes si presentano come soluzioni funzionali e insieme elementi decorativi differenzianti che garantiscono una miriade di possibilità di personalizzazione degli spazi abitativi, residenziali e pubblici.

Single canopies

A - Single

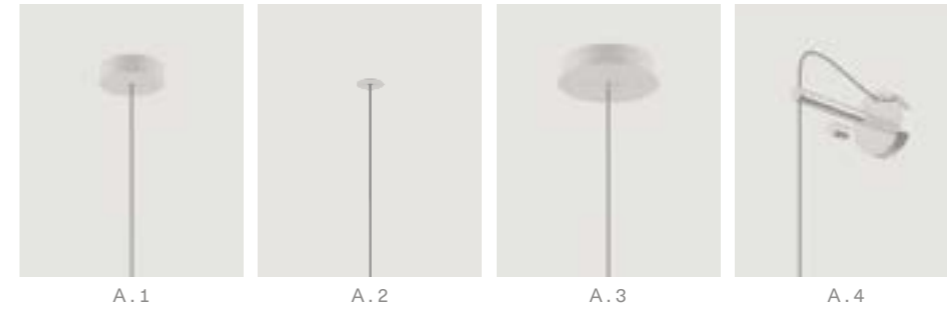

A. 1

A. 2

A. 3

A. 4

Cluster suspension lamps:

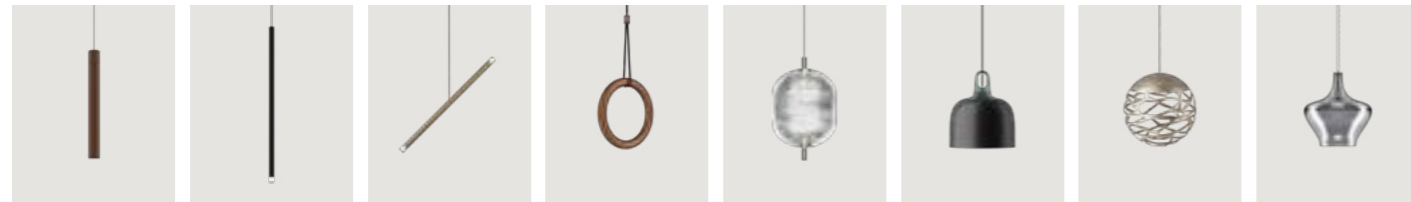

A-Tube
A, B, C, D

A-Tube Nano
A, B, D

A-Tube Nano Duo
A, B, D

IVY I
A, B, D

Jefferson
A, B, D

JIM
A, B, C, D

Kelly Cluster
A, B, C, D

Nostalgia
A, B, C, D

NEW LAMP

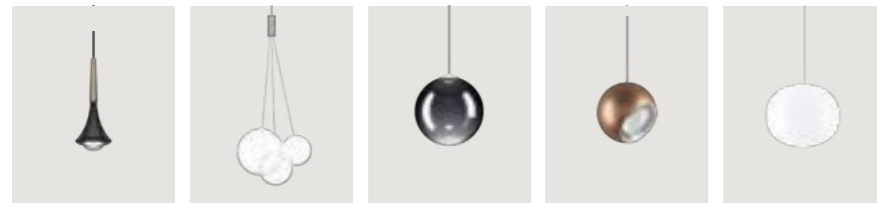

Rain
A, B, C, D

Random
A, B, C, D

Random Solo
A, B, D

Spider
A, B, C, D

Volum
A, B, C, D

NEW LAMP

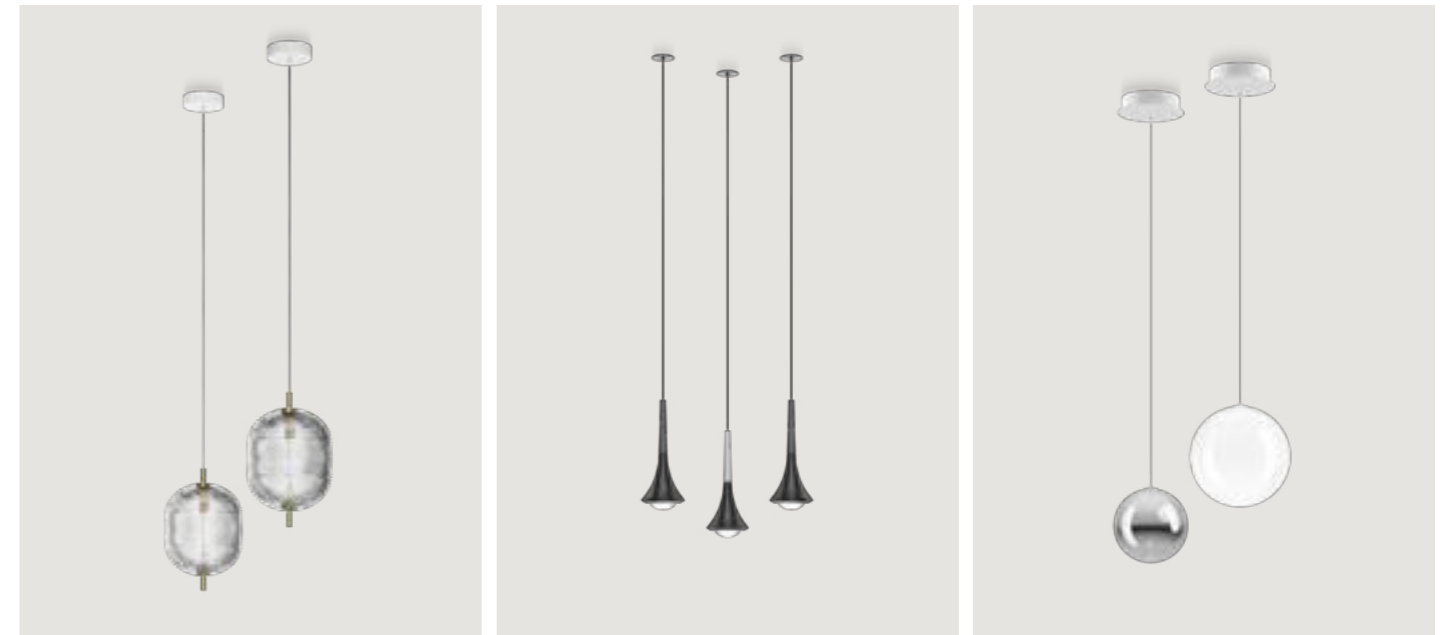

Jefferson, Single Mini ▶ A. 1

Rain, Recessed Micro ▶ A. 2

Random Solo, Single Standard ▶ A. 3

Lodes offers canopies to suit every project. *Single canopies* are ideal for highlighting the corner of a room or enhancing single light sources. They can also be used to create multiple custom combinations on high ceilings or in spaces which do not allow lights to be grouped in a cluster.

Lodes propone rosoni in grado di adattarsi ad ogni progetto. I *rosoni singoli* si prestano ad enfatizzare gli angoli di una stanza o a valorizzare singoli corpi luce. Inoltre, possono essere impiegati per creare composizioni multiple personalizzate su soffitti molto alti o in situazioni che non consentono l'utilizzo di cluster.

Multiple canopies

B - Round

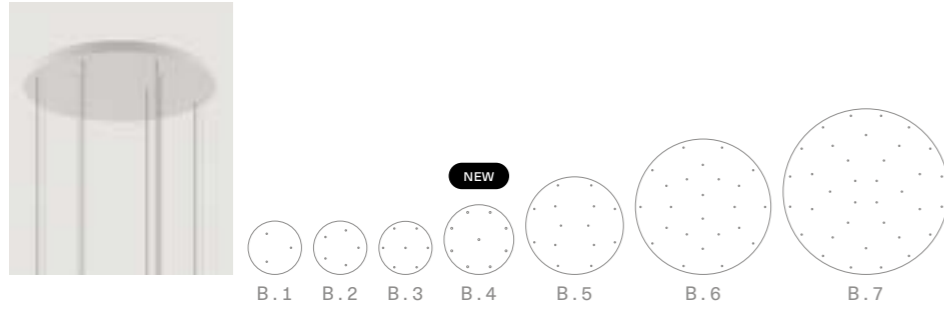

B. 1	3 Lights Round	163
B. 2	5 Lights Round	052
		194
		210
B. 3	7 Lights Round	106
		224
B. 4	9 Lights Round <small>NEW</small>	
B. 5	14 Lights Round	
B. 6	24 Lights Round	068
		069
		219
B. 7	36 Lights Round	066
		149
		179

B - Rectangular

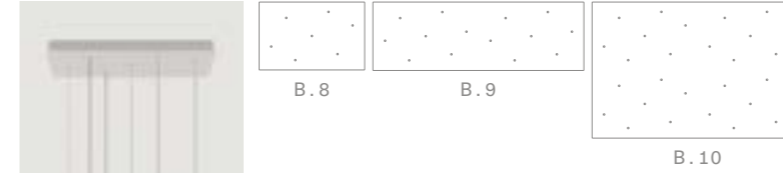

B. 8	7 Lights Rectangular	198
B. 9	14 Lights Rectangular	054
		150
B. 10	28 Lights Rectangular	056

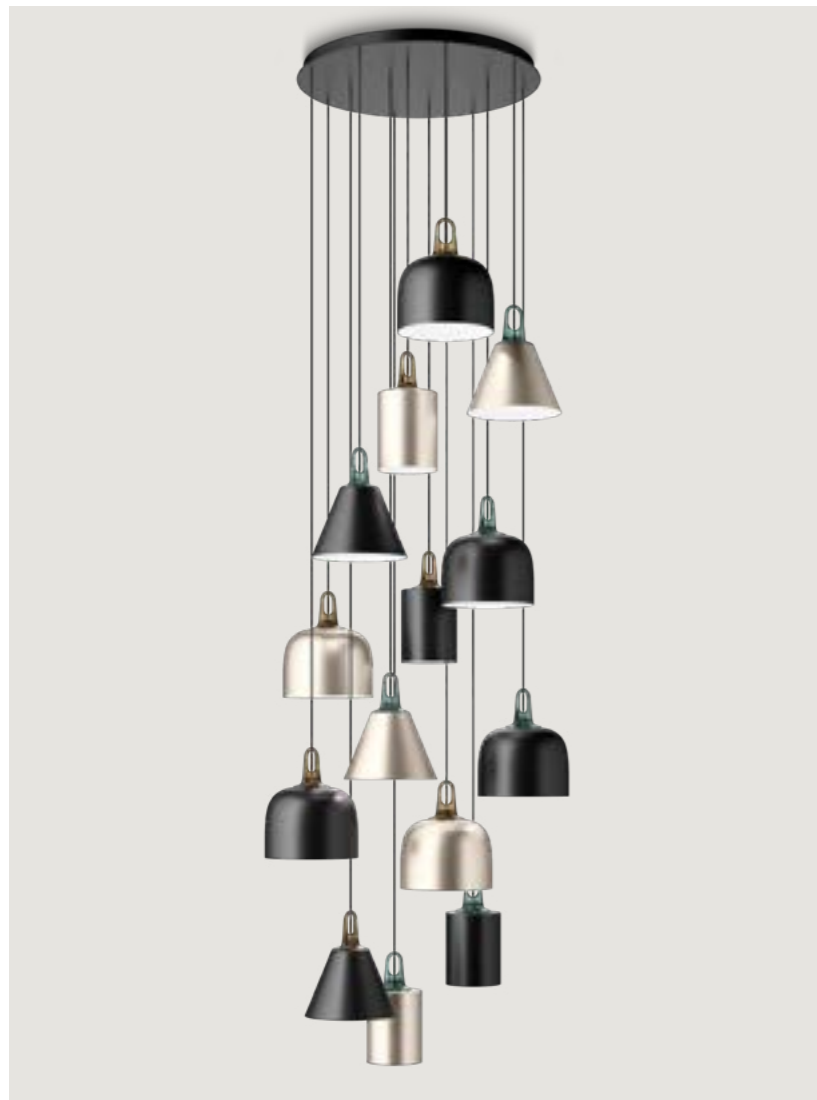

JIM, 14 Lights Round ▶ B. 5



Random Solo, 5 Lights Round ▶ B. 2

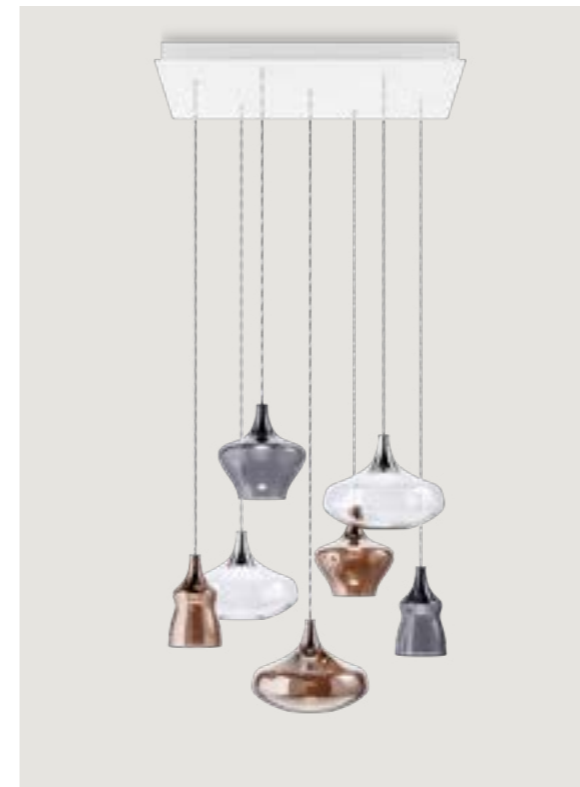

Nostalgia, 7 Lights Rectangular ▶ B. 8



A-Tube Nano, 14 Lights Rectangular ▶ B. 9

For an impactful lighting effect *multiple canopies*, *round* or *rectangular*, are functional systems to create suspended compositions with a variable but predefined number of holes.

Per un'illuminazione di grande impatto, i *rosoni multipli*, *rotondi* o *rettangolari* sono sistemi funzionali che permettono di creare composizioni sospese con un numero di fori variabile ma predefinito.

C - Radial

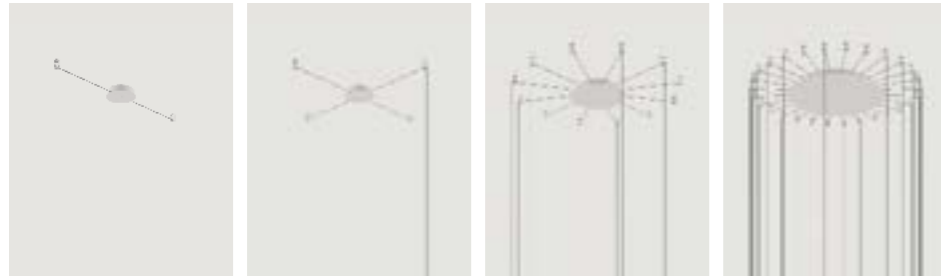

C. 1

C. 2

C. 3

C. 4

C. 1	1-2 Lights Radial	104
C. 2	4 Lights Radial	104
C. 3	12 Lights Radial	110
		118
C. 4	28 Lights Radial	108

D - Track

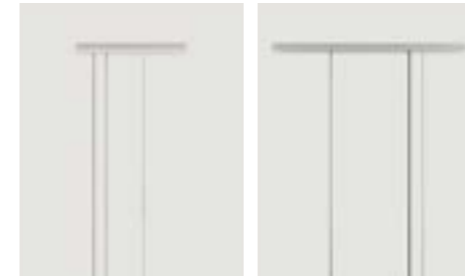

D. 1

D. 2

D. 1	Short Lights Track	035
D. 2	Long Lights Track	078

Meanwhile, *track systems* offer various possibilities of in-line composition with a variable number of lamps depending on the preferred type of installation, for example in projects which require height-aligned or staggered suspensions.

I *sistemi a binario* offrono molteplici possibilità di composizione in linea con un numero variabile di lampade a seconda del tipo di installazione desiderato, ad esempio in caso di progetti che prevedono sospensioni allineate in altezza o sfalsate.



Kelly Cluster, 4 Lights Radial ▶ C. 2



Spider, 12 Lights Radial ▶ C. 3

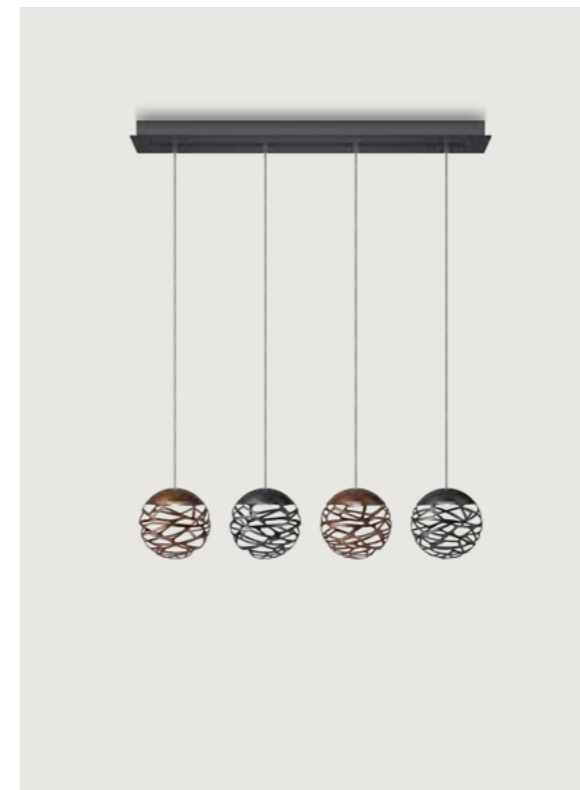

Kelly Cluster, Short Lights Track ▶ D. 1

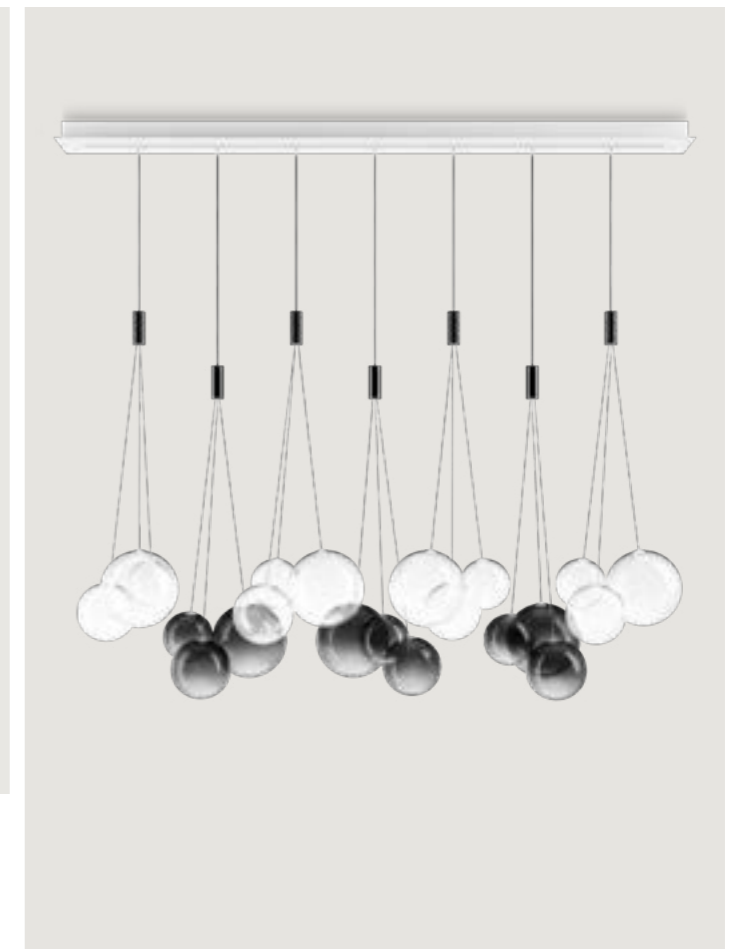

Random, Long Lights Track ▶ D. 2

Alternatively, *radial systems* are an innovative way to separately manage various suspension cables starting from one single canopy, this is a particularly useful way to illuminate spaces with irregular ceilings.

In alternativa, i *sistemi radiali* rappresentano una soluzione innovativa per gestire separatamente diversi cavi di sospensione a partire da un unico rosone, rivelandosi particolarmente utili per illuminare ambienti con soffitti irregolari.

Lodes product configurator

Discover more:



Create truly unique combinations of light fixtures with Lodes' canopies! Select a *lamp*, choose your *canopy* and create your bespoke *composition*.

Crea combinazioni di luci veramente uniche con i rosoni Lodes! Seleziona una *lampada*, scegli il tuo *rosone* e crea la tua *composizione* personalizzata.

Designers

The collaborations with international designers consolidate the company's commitment to distinctive decorative design, continuous development, and experimentation. Lodes' workshop is the place where technical know-how meets new creative perspectives, where designers' creative ideas are shaped and elaborate sketches give life to new product stories.

Le collaborazioni con designer internazionali consolidano l'impegno dell'azienda a creare soluzioni decorative uniche, frutto di continue ricerche e sperimentazioni. L'officina Lodes è il luogo di incontro tra know-how tecnico ed estro in cui le idee creative dei designer prendono forma e schizzi elaborati generano inedite narrazioni di prodotto.

Marco Dessì Cima 278

Chia-Ying Lee Random 174
Random Solo 186

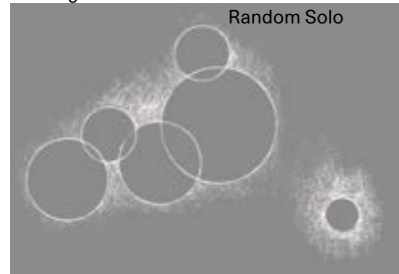

Dima Loginoff Nostalgia 214

Vittorio Massimo IVY 026

Luca Nichetto Aile 304
Croma 264
Easy Peasy 250
Jefferson 204

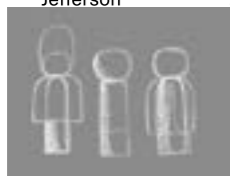

Patrick Norguet Flar 240
JIM 140

Snøhetta Volum 158

Studio Italia Design A-Tube 074
A-Tube Nano 046
A-Tube Nano Duo 064
Bugia 356
Frozen 386
Laser 374
Make-Up 380
Puzzle 340
Puzzle Mega 312
Puzzle Outdoor 348
Puzzle Round 328
Sky-Fall 228
Spider 098

Andrea Tosetto Kelly 124
Kelly Cluster 114
Nautilus 288
Nautilus Mini 288
Pin-Up 368
Rain 084

Pio & Tito Toso Blow 260



Snøhetta

Snøhetta (Norwegian pronunciation: [ˈsnøː ˌhɛtɑ]) has grown to become one of the most internationally renowned Architecture & Design practices globally, with more than 300 employees from 33 different nations and studios around the globe. The practice began as a collaborative architectural and landscape workshop in 1989 and has remained true to its multi-disciplinary way of thinking until this day. We strive to enhance our sense of surroundings, identity and relationship to others and the physical spaces we inhabit – whether human-made or naturally created through the course of time. Museums, product developments, reindeer observatories, visual universes and virtual landscapes all get the same care and attention. Since then, *Snøhetta* has introduced specialised graphic, digital and product design disciplines to enhance our capabilities and reach. These disciplines act at the forefront of sustainable and social innovation. By leveraging the accumulated knowledge and experience at *Snøhetta*, strategic design connects industry, technology, markets and brands with future opportunities and targets. Even with a primarily international approach and staff, *Snøhetta* has maintained a strong and unified culture that is well-rooted within the Nordic model, where equality, openness, generosity, and sustainability are translated into real projects.

Con oltre 300 dipendenti di 33 nazionalità diverse e varie sedi in tutto il mondo, *Snøhetta* (pronuncia norvegese: [ˈsnøː ˌhɛtɑ]) si è affermato tra gli studi di architettura e design più rinomati a livello internazionale. Nato nel 1989 come laboratorio collaborativo di architettura e del paesaggio, lo studio è rimasto sempre fedele al proprio approccio multidisciplinare e si propone di affinare la percezione dell'ambiente circostante, dell'identità e del rapporto con gli altri, ma anche con lo spazio fisico in cui viviamo, sia esso artificiale o plasmato dalla natura nel corso del tempo. Dai musei, agli sviluppi di prodotto, dagli osservatori di renne agli universi visivi fino ai paesaggi virtuali, ogni elemento merita la stessa cura e attenzione. Da allora *Snøhetta* ha introdotto specifiche discipline di design grafico, digitale e di prodotto che, perseguendo lo scopo di potenziare capacità e possibilità, aprono la strada all'innovazione sostenibile e sociale. Grazie al ricco bagaglio di conoscenze ed esperienze messo a punto da *Snøhetta*, il design strategico avvicina l'industria, la tecnologia, i mercati e i brand a opportunità e traguardi futuri. Nonostante il carattere spiccatamente internazionale in termini di approccio e composizione del team, *Snøhetta* ha mantenuto una solida cultura unificata ben radicata nel modello nordico in cui uguaglianza, apertura, generosità e sostenibilità si traducono in progetti concreti.



Volum 158

Patrick Norguet

Patrick Norguet approaches objects and design from a graphical perspective. Since childhood, he has preferred sketchbooks to textbooks, filling them up with sketches and drawings. A "hands-on" approach of industry and design studies in Paris (ESDI) mark the unusual profile of this constructive rebel. His career underwent a dramatic change in 2000 when Giulio Cappellini spotted his now famous Rainbow Chair. He joined the circle of designers that matter and created his Parisian studio. Since that time, he has been designing for major producers and renowned brands. For *Patrick Norguet*, design is first and foremost about happy encounters. What he is most passionate about is exchanging with manufacturers, discovering their know-how; the impulse of a creative intention refined by technical constraints, economic stakes and the expectations of a user whom he hopes to discreetly but durably win over. Drawing inspiration from everything that surrounds him, *Patrick Norguet* does not follow trends but seeks to give shape to products whose relevance and modernity would withstand the test of time: "A well-designed object, an object created through generous collaboration is timeless." From consumer products to luxury objects, *Patrick Norguet* leaves an impression of authenticity and elegance. Today, he is an essential figure on the international design scene.

Patrick Norguet si avvicina agli oggetti e al design da una prospettiva grafica. Fin dall'infanzia ha preferito i taccuini da disegno ai libri di testo, riempiendoli di schizzi e bozzetti. Un approccio "pratico" agli studi industriali e di design a Parigi (ESDI) segna il profilo insolito di questo ribelle costruttivo. La sua carriera ha subito una svolta straordinaria nel 2000, quando Giulio Cappellini ha notato la sua ormai famosa Rainbow Chair. Entra a far parte della cerchia dei designer che contano e crea il suo studio parigino. Da allora, progetta per grandi produttori e marche rinomate. Per *Patrick Norguet*, il design è prima di tutto sinonimo di incontri felici. Ciò che più lo appassiona è lo scambio con i produttori, la scoperta del loro know-how; l'impulso di un'intenzione creativa affinata da vincoli tecnici, da aspetti economici e dalle aspettative dell'utilizzatore che spera di conquistare in modo discreto ma duraturo. Traendo ispirazione da tutto ciò che lo circonda, *Patrick Norguet* non segue le tendenze, ma cerca di dare forma a prodotti la cui attualità e modernità possano resistere alla prova del tempo: "Un oggetto ben progettato, un oggetto creato grazie a una collaborazione generosa è senza tempo". Dai prodotti di consumo agli oggetti di lusso, *Patrick Norguet* lascia un'impressione di autenticità ed eleganza. È oggi una figura essenziale nel panorama del design internazionale.



Flar 240
JIM 140

Studio *Marco Dessí* is a multidisciplinary design studio based in Vienna. The studio's approach is practical and collaborative, where design is understood as an interactive process. Self-initiated ventures serve to experiment with materials and test processes that can be later applied onto commercial projects and / or developed further to meet the requirements of industrial or handmade replication. Commissioned design work always starts with immediate study of the client, their respective production methods and methods' inherent potentials. Dessí's studio is not committed to any particular style, preferred material or unified formula, but rather regards designing as a trade characterised by a deep understanding of materials, processes and how the two are linked. The way in which an object is produced has a direct influence over its aesthetic appearance and the story that it tells. In his work, *Marco Dessí* values transparency in terms of a consistent link between the process of designing and the actual conditions of production. Established in 2008, the studio works with a list of international clients and cultural institutions on a variety of scales, ranging from furniture and product design to spatial solutions.

Marco Dessí è uno studio di design multidisciplinare con sede a Vienna. Adottando un approccio pratico e collaborativo, lo studio concepisce il design come un processo interattivo. Le iniziative autonome si inseriscono in un'ottica di sperimentazione dei materiali e dei processi finalizzata alla successiva applicazione ai progetti commerciali e/o all'ulteriore sviluppo in funzione dei requisiti di produzione industriale o artigianale. I lavori commissionati non possono prescindere, in primo luogo, da un'analisi accurata del cliente, dei rispettivi metodi produttivi e delle relative potenzialità. Lo studio Dessí non si ispira ad uno stile specifico né predilige un materiale o si basa su una formula universale, bensì si dedica alla progettazione come attività caratterizzata da una profonda comprensione dei materiali, dei processi e del legame tra tali elementi. Il modo in cui un oggetto viene prodotto incide direttamente sulla sua estetica e sulla storia che racconta. Per questo, nei propri lavori *Marco Dessí* fa della trasparenza il nesso coerente tra il processo di progettazione e le effettive condizioni produttive. Fondato nel 2008, lo studio collabora con clienti internazionali e istituzioni culturali impegnate in settori eterogenei che spaziano dalla progettazione di arredi e prodotti alle soluzioni spaziali.



Cima 278

Multidisciplinary designer *Luca Nichetto* was born in 1976 in Venice. He studied at the city's Istituto Statale d'Arte and Università IUAV di Venezia, graduating in 1998. The following year, he joined Salviati, later becoming a product designer and consultant for Foscarini. Luca set up *Nichetto Studio* in 2006 in Venice. Five years later he moved to Stockholm to start his family and open a second studio. Luca has served as art director for many design brands and gained a reputation as a multidisciplinary designer. He has lectured at several universities and has sat on juries for international design competitions. His work is often featured in exhibitions worldwide and has been the subject of retrospectives worldwide. Nichetto's projects have earned him an array of awards for designs that range from products, accessories and furniture to architecture, exhibition design and branding.

Il designer multidisciplinare *Luca Nichetto* nasce a Venezia nel 1976. Intraprende gli studi all'Istituto Statale d'Arte della città per poi iscriversi all'Università IUAV, dove si laurea nel 1998. L'anno successivo inizia una collaborazione con Salviati e a seguire con Foscarini come product designer e consulente. Nel 2006 fonda *Nichetto Studio* a Venezia e cinque anni dopo si trasferisce a Stoccolma, dove mette su famiglia e apre il secondo studio. Luca ha collaborato con diversi brand di design come art director, guadagnandosi la reputazione di designer multidisciplinare, ha tenuto conferenze in diverse università e ha partecipato come giurato a molteplici concorsi internazionali di design. Le sue opere, spesso esibite in prestigiose esposizioni di respiro internazionale, sono state oggetto di mostre retrospettive in tutto il mondo. I progetti firmati Nichetto hanno ricevuto numerosi riconoscimenti nell'ambito del design, spaziando dai prodotti, agli accessori e complementi d'arredo fino all'architettura, agli allestimenti espositivi e al branding.



Aile 304
Croma 264
Easy Peasy 250
Jefferson 204

Architect *Vittorio Massimo* was born in Treviso in 1981. In 2007 he began a three-year collaboration with John Pawson Architects in London and with MZC+ in Treviso until 2017. Meanwhile, he continues his professional activity with private commissions and participates and wins several awards in national and international competitions. In 2010 he was a European finalist in Galway, Ireland, for the design of a section of the city, and later won second prize in Galliera Veneta, Padua, for the new museum and civic centre in the city centre, and first prize for the design of the historic centre of the hamlet of Palazzolo di Sona, near Verona. In 2020 the project for the Maison 203 showroom was included in the first list of architectures nominated for the Archdaily best building of the year award and in 2021 he was among the winners of the Big See award with the same project. He works in parallel in product design and lighting design, and in 2014 he won the Chicago Athenaeum Good Design Award.

L'architetto *Vittorio Massimo* nasce a Treviso nel 1981. Dal 2007 inizia una collaborazione di tre anni con lo studio John Pawson Architects di Londra e con lo studio MZC+ di Treviso, che prosegue fino al 2017. Parallelamente segue la propria attività professionale con incarichi privati e partecipando e vincendo diversi premi in concorsi nazionali e internazionali. Nel 2010 è finalista europeo a Galway, in Irlanda, per la sistemazione di un brano di città, successivamente vince il secondo premio a Galliera Veneta, Padova, per il nuovo museo e centro civico nel centro cittadino, e il primo premio per la sistemazione del centro storico della frazione di Palazzolo di Sona, presso Verona. Nel 2020 il progetto per lo showroom Maison 203 rientra nella prima lista di architetture nominate per il premio di miglior edificio dell'anno per Archdaily e nel 2021 è tra i vincitori, con lo stesso progetto, del Big See award. Lavora parallelamente nell'ambito del design di prodotto e nel lighting design, e nel 2014 vince il Chicago Athenaeum Good Design Award.



IVY 026



Chia-Ying Lee was born in Taiwan and became a designer in new media and industrial design after studying computer science and music. She graduated from the Interaction Design Institute Ivrea in 2006. After working for PEGA Design & Engineering for three years, she set up her studio (studio if) in December 2011. Her work is a blend of design, art and technology embodied in physical forms, from products to installations. She has worked with important institutes such as the National Taiwan Art Museum and the JUT Foundation for Arts and Architecture. Studio if also runs small production of her works for stores and galleries in Europe, Taipei and Beijing. Her projects have won various awards including "IF China Product Design Award", "Taiwan Excellence Award" and "SDA Best Design of The Year". She was selected as one of the IFFS Asian Star Talents in 2015. That same year she designed *Random* for *Lodes*.

Chia-Ying Lee è nata a Taiwan e, dopo aver studiato informatica e musica, è diventata progettista di design industriale e new media. Laureata all'Interaction Design Institute di Ivrea nel 2006, ha lavorato per tre anni per PEGA Design & Engineering, per poi fondare il suo studio (studio if) nel dicembre 2011. Il suo lavoro è una fusione di design, arte e tecnologia incarnata in forme fisiche, dai prodotti alle installazioni. Ha collaborato con grandi istituti come il National Taiwan Art Museum e la JUT Foundation for Arts and Architecture. Lo studio if realizza anche piccole produzioni delle sue opere per negozi e gallerie in Europa, Taipei e Pechino. I suoi progetti hanno vinto diversi premi tra cui "IF China Product Design Award", "Taiwan Excellence Award" e "SDA Best Design of The Year". Nel 2015 è stata selezionata tra i talenti asiatici all'IFFS. Nello stesso anno ha progettato *Random* per *Lodes*.



Random 174
Random Solo 186

Dima Loginoff

Dima Loginoff was born in 1977 in Moscow, where in 1997 he graduated from the College of Hairdresser's Art and then worked as a designer for over 10 years. In 2008 he graduated with distinction from the International Design School in Moscow and the Rhodex International Interior Design School in London. Over time he has received important awards including the "Grand Prix Award" in 2007, the "Young Designer of the Year-2010" by Elle Magazine, the "Twelve Golden" by the Russian magazine Interior + Design, several publications in magazines around the world, as well as awards from fashion agencies such as Agenda Inc. (Paris and New York). In 2009, together with other well-known Russian designers, Dima participated in the charity event "The Stars Draw", the proceeds of which allowed the purchase of tools to promote the creative skills of children in orphanages. Today, in addition to new projects, *Dima Loginoff* teaches in specialisation courses and holds design seminars. For *Lodes* she designed the acclaimed *Nostalgia* suspension lamp.

Dima Loginoff è nato nel 1977 a Mosca, dove nel 1997 si è laureato al College of Hairdresser's Art e poi ha lavorato come stilista per oltre 10 anni. Nel 2008 si è laureato con merito alla International Design School di Mosca e alla Rhodex International Interior Design School di Londra. Nel tempo ha ricevuto importanti riconoscimenti tra cui il "Grand Prix Award" nel 2007, il "Young Designer of the Year-2010" di Elle Magazine, il "Twelve Golden" della rivista russa Interior + Design, diverse pubblicazioni su riviste di tutto il mondo, nonché premi da agenzie di moda come Agenda Inc. (Parigi e New York). Nel 2009, insieme ad altri noti designer russi, Dima ha partecipato all'evento benefico "The Stars Draw", il cui ricavato ha permesso l'acquisto di strumenti per sviluppare le capacità creative dei bambini negli orfanotrofi. Oggi, accanto a nuovi progetti, *Dima Loginoff* insegna in corsi di specializzazione e tiene seminari di design. Per *Lodes* ha progettato l'acclamata sospensione *Nostalgia*.



Nostalgia 214

Pio & Tito Toso

Pio and Tito are brothers, born in 1973 and 1971 in Venice, where they graduated in Architecture in 1998. In 1996 they founded their design studio *Pio & Tito Toso*. The Studio works on architecture projects in Italy and abroad, and takes parts in numerous contests. In the field of industrial design the Toso brothers boast projects with the most qualified lighting and furniture companies. They also plan and design booths, exhibitions, shops, offices and warehouses for several companies, curating image and identity. The list of awards they received includes Design Plus Award 2016, Red Dot Design Award 2015, Red Dot Design Award 2012 Good Design Award 2009, I.Dot selection 2006–2007, Young & design 2005. They have participated in exhibitions in Europe and the United States.

I fratelli Pio e Tito nascono nel 1973 e nel 1971 a Venezia dove si laureano in architettura nel 1998. Nel 1996 aprono lo studio di progettazione *Pio & Tito Toso*. Lavorano nel campo dell'architettura realizzando numerosi progetti sul territorio nazionale ed internazionale e partecipano a vari concorsi. Nel campo del design industriale vantano collaborazioni con le aziende più qualificate nell'illuminazione e nell'arredo. Progettano stand, esposizioni, negozi, uffici e magazzini per diverse ditte, curandone l'immagine e la grafica. La lista dei riconoscimenti che hanno ricevuto include Design Plus 2016, Red Dot Design Award 2015, Red Dot Design Award 2012, Good Design Award 2009, selezione I.Dot 2006–2007, Young & design 2005. Hanno partecipato a mostre in Europa e Stati Uniti.



Blow 260

Andrea Tosetto

Andrea Tosetto studied at the Art High School and at the Accademia delle Belle Arti in Venice. At the age of 18, he joined the company founded by his father Angelo in 1950, which he soon took over. Andrea marks the transition of the company from the classical lines of that time to an innovative and more contemporary language. His dynamic entrepreneurial style and lively creative vein come to life in refined products that enhance the craftsmanship method. Andrea succeeded in emphasising the company's know-how, focusing on the internalisation of production processes and on the use of quality materials with a strong bond with the Venetian territory. *Kelly*, *Nautilus* are just some of Andrea's creations for *Lodes*.

Andrea Tosetto si forma al Liceo Artistico e all'Accademia delle Belle Arti di Venezia. A 18 anni entra a far parte dell'azienda fondata dal padre Angelo nel 1950, di cui presto prenderà le redini. Andrea segna il passaggio dell'azienda dalle linee classiche dell'epoca ad un linguaggio innovativo e più contemporaneo. Il suo stile imprenditoriale dinamico e la sua vena creativa vivace prendono forma in prodotti curati che esaltano il sistema di lavorazione artigianale. Andrea ha saputo dare protagonismo al saper-fare dell'azienda, mirando all'internalizzazione dei processi di produzione e all'utilizzo di materiali di qualità con un forte legame con il territorio veneziano. *Kelly*, *Nautilus*, sono solo alcune delle creazioni di Andrea per *Lodes*.



Kelly	124
Kelly Cluster	114
Nautilus	288
Nautilus Mini	288
Pin-Up	368
Rain	084

Studio Italia Design

Very often teamwork generates winning ideas. This has been the experience for *Studio Italia Design*, a creative workshop that brings together different intuitions and gives shape to the ideas of the company's own people-technical and creative staff, insiders who know the sector deeply. The results of the synergy of craft, curiosity and speed, contaminated by the endless energy of *Andrea Tosetto*, are firmly established success stories, like the suspension lamp *Sky-Fall*, or the *A-Tube* and *Puzzle* collections.

Dal lavoro di squadra nascono molto spesso idee vincenti. È questa l'esperienza di *Studio Italia Design*, un laboratorio creativo che accoglie le intuizioni e dà forma alle idee delle persone dell'azienda, tecnici, creativi, conoscitori del settore. I risultati della sinergia di mestiere, curiosità e velocità, contaminati dall'energia inesauribile di *Andrea Tosetto*, sono storie di successo ormai consolidate, come la lampada a sospensione *Sky-Fall* e le collezioni *A-Tube* e *Puzzle*.



A-Tube	074
A-Tube Nano	046
A-Tube Nano Duo	064
Bugia	356
Frozen	386
Laser	374
Make-Up	380
Puzzle	340
Puzzle Mega	312
Puzzle Outdoor	348
Puzzle Round	328
Sky-Fall	228
Spider	098



New lamps 2022

01-02-03	Volum 14 Volum 22 Volum 29 <i>design by Snøhetta</i> Cluster suspension lamp	158
04	Volum 42 <i>design by Snøhetta</i> Suspension lamp	158
05	IVY I <i>design by Vittorio Massimo</i> Cluster suspension lamp	026
06	IVY V <i>design by Vittorio Massimo</i> Central cluster suspension lamp, Suspension lamp	026
07	Croma <i>design by Luca Nichetto</i> Floor lamp	264
08-09	Flar large Flar medium <i>design by Patrick Norguet</i> Table lamp, Floor lamp	240
10	Spider <i>design by Studio Italia Design</i> Ceiling lamp	098

Cluster suspension lamps

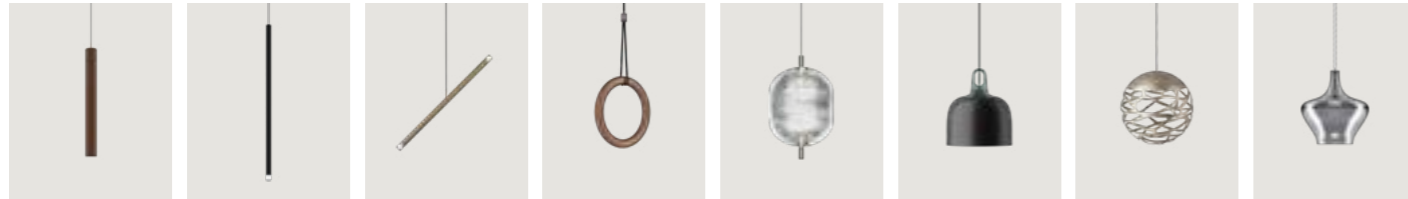

A-Tube Pag. 074 A-Tube Nano Pag. 046 A-Tube Nano Duo Pag. 064 IVY I Pag. 026 **NEW LAMP** Jefferson Pag. 204 JIM Pag. 140 Kelly Cluster Pag. 114 Nostalgia Pag. 214

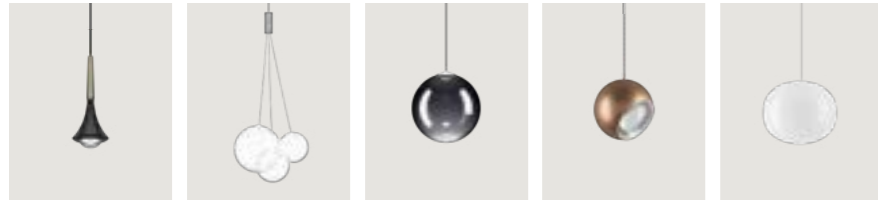

Rain Pag. 084 Random Pag. 174 Random Solo Pag. 186 Spider Pag. 098 Volum Pag. 158 **NEW LAMP**

Suspension lamps



Cima Pag. 278 IVY V Pag. 026 **NEW LAMP** JIM Pag. 140 Sky-Fall Pag. 228 Kelly dome Pag. 124 Kelly sphere Pag. 124 Volum Pag. 158 **NEW LAMP**

Wall lamps



Aile Pag. 304 Kelly Pag. 124 Laser Pag. 374 Make-Up Pag. 380 Nautilus Pag. 288 Nautilus Mini Pag. 288 Pin-Up Pag. 368 Puzzle Pag. 340



Puzzle Mega Pag. 312 Puzzle Round Pag. 328

Ceiling lamps



A-Tube Pag. 074 Bugia Pag. 356 Frozen Pag. 386 Make-Up Pag. 380 Nautilus Pag. 288 Nautilus Spot Pag. 288 Pin-Up Pag. 368 Puzzle Pag. 340



Puzzle Mega Pag. 312 Puzzle Round Pag. 328 Spider Pag. 098 **NEW LAMP**

Floor lamps



Cima Pag. 278 Croma Pag. 264 **NEW LAMP** Flar Pag. 240 **NEW LAMP**

Table lamps

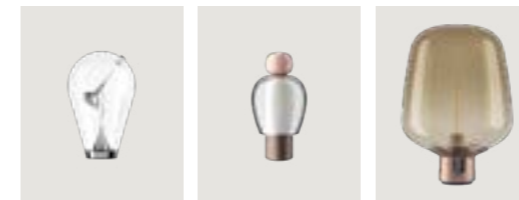

Blow Pag. 260 Easy Peasy Pag. 250 Flar Pag. 240 **NEW LAMP**

Outdoor lamp



Puzzle Outdoor Pag. 348

IVY

IVY is a minimal, geometric lighting piece composed of a die-cast zinc alloy ring hanging on a black cable, which gives power to a made to measure LED module. The product sheds an even, rounded light beam through its thin and curved methacrylate diffuser. Designed with single and double cables, IVY responds to the need for flexibility, an increasingly contemporary theme in architectural practice and restoration, allowing the luminaire to be released from its ceiling derivation. Imagining the repetition and clustering of several lamps suggested the name IVY, while the ring reminds of a precious pendant on a necklace.

IVY è una lampada dalle linee minimaliste e geometriche costituita da un anello in lega di zinco pressofuso sospeso ad un cavo nero che aziona un modulo a LED realizzato su misura. Il prodotto emette un fascio di luce uniforme e omogeneo attraverso il sottile diffusore curvo in metacrilato. Dotata di cavi singoli e doppi, IVY risponde alla crescente esigenza di flessibilità nell'attuale contesto delle attività architettoniche e di ristrutturazione, consentendo di riposizionare la lampada rispetto alla fonte di alimentazione a soffitto. L'idea della ripetizione e del raggruppamento di più lampade ha ispirato il nome IVY, dall'inglese "edera", mentre l'anello richiama il prezioso ciondolo di una collana.

IVY I, Cluster suspension lamp

IVY V, Suspension lamp, Central cluster suspension lamp

IVY I and V, FINISHES Matte
Champagne and Matte Terra

IVY, *design by* Vittorio Massimo, 2022





IVY I, composition of 14 lights on a *rectangular canopy*, FINISHES Matte Black, Champagne and Terra

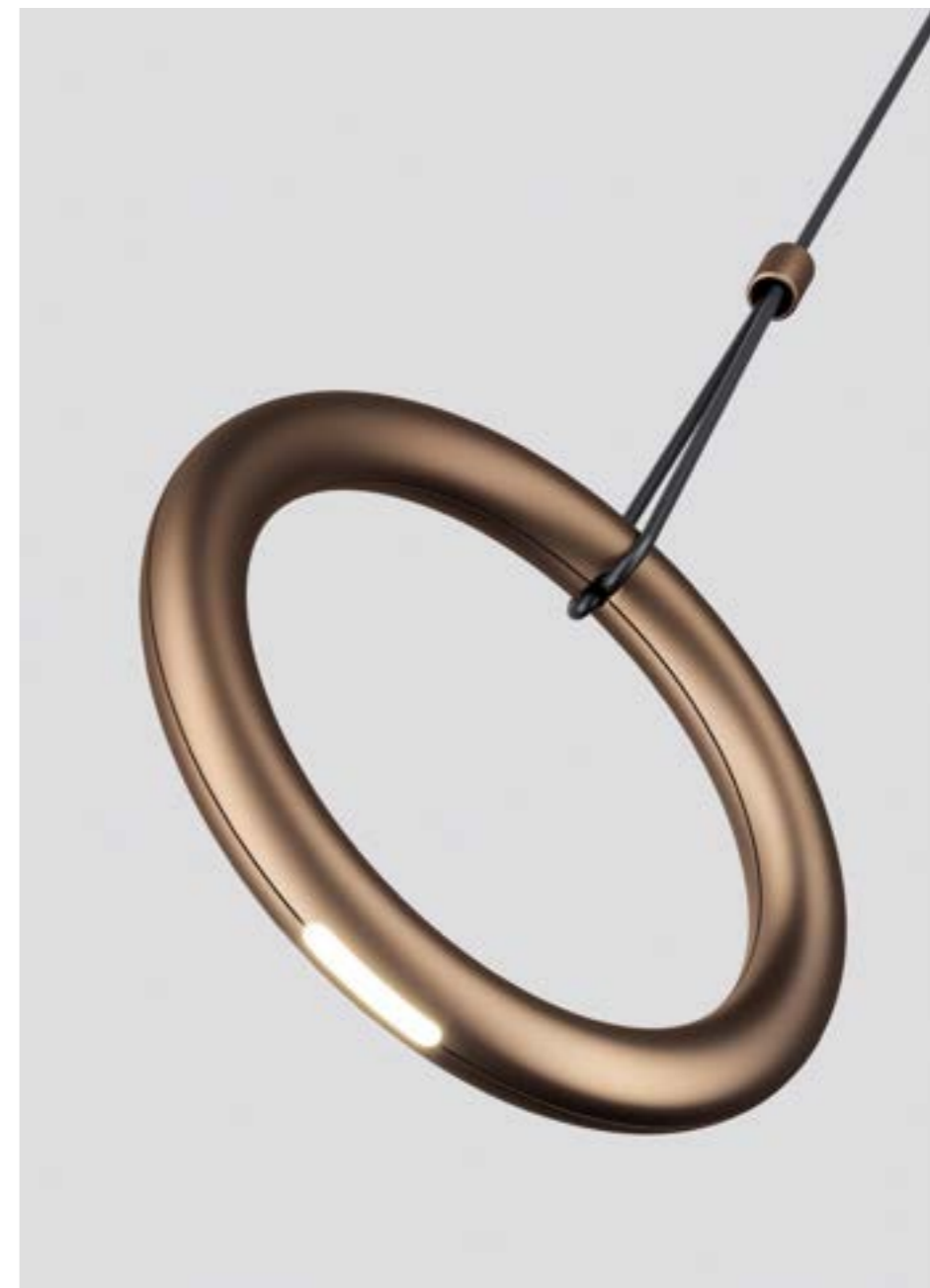

IVY I, FINISH Matte Terra, LED light source



IVY I, FINISHES Matte Black and Champagne

IVY I, composition of 36 lights on a *round canopy*, FINISHES Matte Black and Champagne





IVY I and V, FINISHES Matte Black, Champagne and Terra

IVY I and V, *single mini canopies*,
FINISH Matte Terra



IVY V, composition of 8 lights on a *central canopy*, FINISHES Matte Terra and Champagne
CENTRE: IVY I, *recessed micro canopies*, FINISH Matte Champagne

IVY I, 2 × composition of 3 lights on a *short track*, FINISHES Matte Terra and Champagne



1



2

1-IVY V, FINISH Matte Champagne
2-IVY V, FINISH Matte Terra

IVY V, composition of 6 lights
on a *central canopy*, FINISH Matte Black



037

IVY

Cluster suspension lamp, Suspension lamp



IVY V, composition of 10 lights on a *central canopy*, FINISHES Matte Champagne and Black

IVY est un élément d'éclairage minimaliste et géométrique fait d'un anneau en alliage de zinc moulé sous pression, suspendu à un câble noir qui alimente un module LED sur mesure. Le produit diffuse un faisceau lumineux uniforme et arrondi grâce à son diffuseur en méthacrylate fin et incurvé. Conçu avec des câbles simples et doubles, IVY répond au besoin de flexibilité, un thème de plus en plus contemporain dans la pratique architecturale et la restauration, permettant au luminaire d'être libéré de sa dérivation de plafond. Le nom IVY, anglais pour « lierre », s'inspire du regroupement de plusieurs lampes en cluster, tandis que l'anneau rappelle le précieux pendentif d'un collier. ● FR

IVY ist ein minimalistisches, geometrisches Beleuchtungsobjekt, bestehend aus einem Ring aus druckgegossener Zinklegierung, aufgehängt an einem schwarzen Kabel, das ein maßgefertigtes LED-Modul mit Strom versorgt. Das Produkt wirft einen gleichmäßigen, runden Lichtstrahl durch seinen dünnen und gebogenen Methacrylat-Diffusor. Entworfen mit einzelnen und doppelten Kabeln ist IVY die Antwort auf das Bedürfnis nach Flexibilität, ein zunehmend aktuelles Thema in der architektonischen Praxis und Restoration, das es der Leuchte ermöglicht, sich von ihrer Deckenableitung zu lösen. Die Vorstellung von der Wiederholung und Cluster mit mehreren Leuchten inspirierten zu dem Namen IVY, englisch für „Efeu“, während der Ring an einen kostbaren Anhänger einer Halskette erinnert. ● DE

IVY es un elemento de iluminación minimalista y geométrico compuesto de un aro de aleación de cinc fundido que cuelga de un cable negro, el cual alimenta a un módulo LED hecho a medida. La lámpara proyecta un haz de luz redondeado y homogéneo a través de su fino y curvado difusor de metacrilato. Diseñada con cables individuales y dobles, IVY responde a la necesidad de flexibilidad, una temática cada vez más de actualidad en la arquitectura y la restauración, que permite liberar el punto de luz de su derivación en el techo. El nombre IVY, «hiedra» en inglés, sugiere la repetición y la agrupación de varias lámparas, mientras que su aro recuerda al colgante de un collar. ● ES

IVY – это минималистичный геометрический осветительный элемент, состоящий из литого под давлением кольца, выполненного из цинкового сплава, подвешенного на черном кабеле, подающем питание к индивидуально изготовленному светодиодному модулю. Лампа излучает ровный круглый световой луч, проходящий через тонкий и изогнутый диффузор из метакрилата. Спроектированная с использованием одинарных и двойных кабелей, лампа IVY отвечает потребности в универсальности, все более актуальной в современной архитектуре и реконструкциях, позволяя освободить светильник от связи с потолком. Образ повторяющихся и объединенных в кластер ламп подсказал название IVY, что в переводе с английского означает "плющ", само кольцо напоминает драгоценный кулон на кольце. ● RU

IVY 是一款极简几何照明件,由一只悬挂于一根黑色线缆上的压铸锌合金圆环组成,线缆可为定制型LED模块供电。该产品通过其细薄而弯曲的甲基丙烯酸酯灯罩散发均匀的圆形光束。采用单线缆和双线缆设计,IVY回应了对灵活性的需求,这是建筑实践与装修中一个日趋现代的主题,可将灯具重新定位于一个与位于天花板的电源处有所不同的地方。IVY之名建立在对更多灯件的重复和组吊的想象中,而圆环则令人忆起项链上的精美吊坠。● ZH

Visit website:



IVY I ▸ Cluster suspension lamp **NEW LAMP**

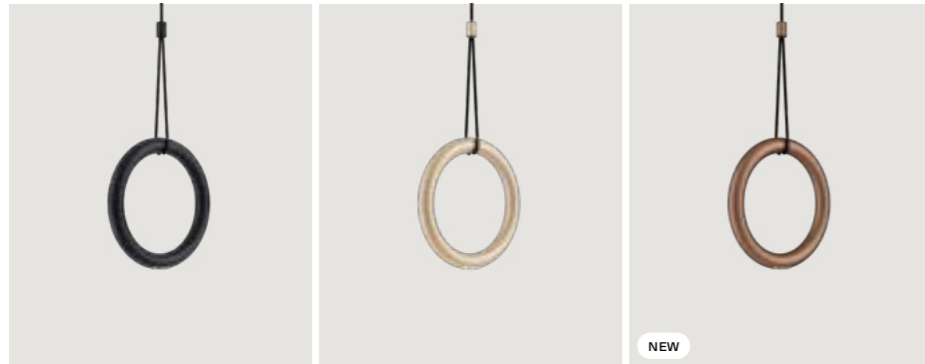

IVY V ▸ Central cluster suspension lamp, Suspension lamp **NEW LAMP**

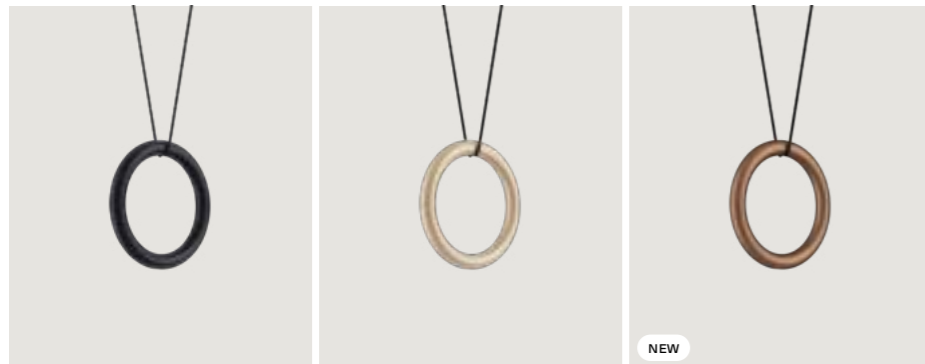

IVY I, design by Vittorio Massimo, 2022

Cluster suspension lamp

IVY I NEW

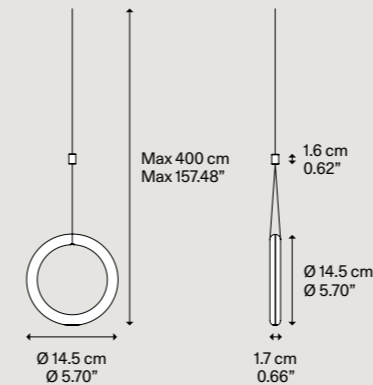

Net weight / Peso netto: 0.5 kg

Pack / Colli: 1

Light source Sorgente luminosa

LED
▸ 2700 K
▸ 3 W / 450 lm
▸ 350 mA
▸ CRI 90
▸ MacAdam 3-Step

LED
▸ 3000 K
▸ 3 W / 480 lm
▸ 350 mA
▸ CRI 90
▸ MacAdam 3-Step

LED and driver included
LED e driver inclusi

Metal structure Montatura in metallo

● Matte Black – 9005
● Nero Opaco – 9005

● Extra Matte Champagne
● Champagne Extra Opaco

● Terra NEW
● Terra

● Matte Black – 9005
● Nero Opaco – 9005

● Extra Matte Champagne
● Champagne Extra Opaco

● Terra NEW
● Terra

Black cable
Cavo Nero

Code Codice

17810 2020

17810 4520

17810 6720

17810 2035

17810 4535

17810 6735

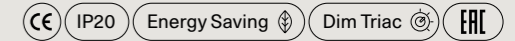

Suspension lamps must be installed on a canopy ▶ pag. 396–403
Le lampade a sospensione devono essere installate su rosone ▶ pag. 396–403

Example of composition

R08L98 1000

Short Lights Track

5 × 17810 2020

Example of composition

R04L07 2000

7 Lights Round

3 × 17810 2020

2 × 17810 4520

2 × 17810 6720

IVY V, design by Vittorio Massimo, 2022

Central cluster suspension lamp

IVY V NEW

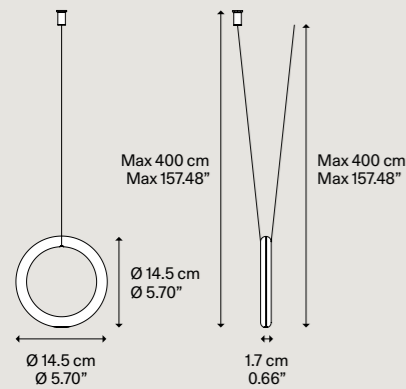

Light source Sorgente luminosa	Metal structure Montatura in metallo	Code Codice
LED ↗ 2700 K ↗ 3 W/450 lm ↗ 350 mA ↗ CRI 90 ↗ MacAdam 3-Step	● Matte Black - 9005 Nero Opaco - 9005	17820 2020
or	● Extra Matte Champagne Champagne Extra Opaco	17820 4520
	● Terra NEW Terra	17820 6720
LED ↗ 3000 K ↗ 3 W/480 lm ↗ 350 mA ↗ CRI 90 ↗ MacAdam 3-Step	● Matte Black - 9005 Nero Opaco - 9005	17820 2035
	● Extra Matte Champagne Champagne Extra Opaco	17820 4535
	● Terra NEW Terra	17820 6735
LED and driver included LED e driver inclusi	Black cable Cavo Nero	

Net weight/Peso netto: 0.58 kg Pack/Colli: 1

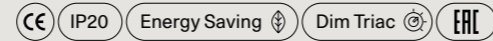

IVY V suspension lamps must only be installed on the single and central canopies below
Le lampade a sospensione IVY V devono essere installate solamente sui rosoni singoli e centrali di seguito

Single canopy

Single Mini

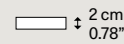
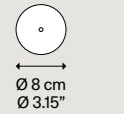

Description Descrizione	Metal structure Struttura in metallo	System Sistema	Code Codice
Single ceiling bracket small size	● Matte Black - 9005 Nero Opaco - 9005	Single	R02L01 2000
Rosone per lampada singola versione mini			

Net weight/Peso netto: 0.13 kg Pack/Colli: 1



Recessed canopy

Recessed Micro

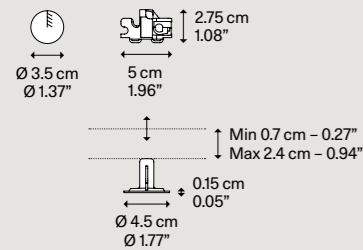

Description Descrizione	Methacrylate structure Struttura in metacrilato	System Sistema	Code Codice
Recessed bracket for single lamp max capacity 3.5 kg	● Matte Black Nero Opaco	Recessed	R01L01 2000
Rosone da incasso per lampada singola portata max 3.5 kg			

Net weight/Peso netto: 0.025 kg Pack/Colli: 1



IVY V, design by Vittorio Massimo, 2022

Central canopy

6 Lights Central NEW

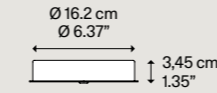
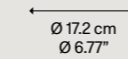

Net weight/Peso netto: 0.90 kg Pack/Colli: 1

Description Descrizione	Metal structure Struttura in metallo	System Sistema	Code Codice
Central canopy max 6 suspension	● Matte Black - 9005 Nero Opaco - 9005	Cluster Central	R07L06 2000
Rosone centrale max 6 sospensioni			

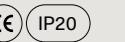

12 Lights Central NEW

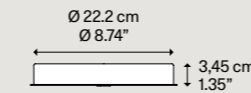
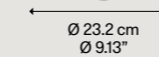
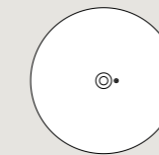

Net weight/Peso netto: 1.20 kg Pack/Colli: 1

Description Descrizione	Metal structure Struttura in metallo	System Sistema	Code Codice
Central canopy max 12 suspension	● Matte Black - 9005 Nero Opaco - 9005	Cluster Central	R07L12 2000
Rosone centrale max 12 sospensioni			



Central cluster suspension lamp

IVY V Examples of composition

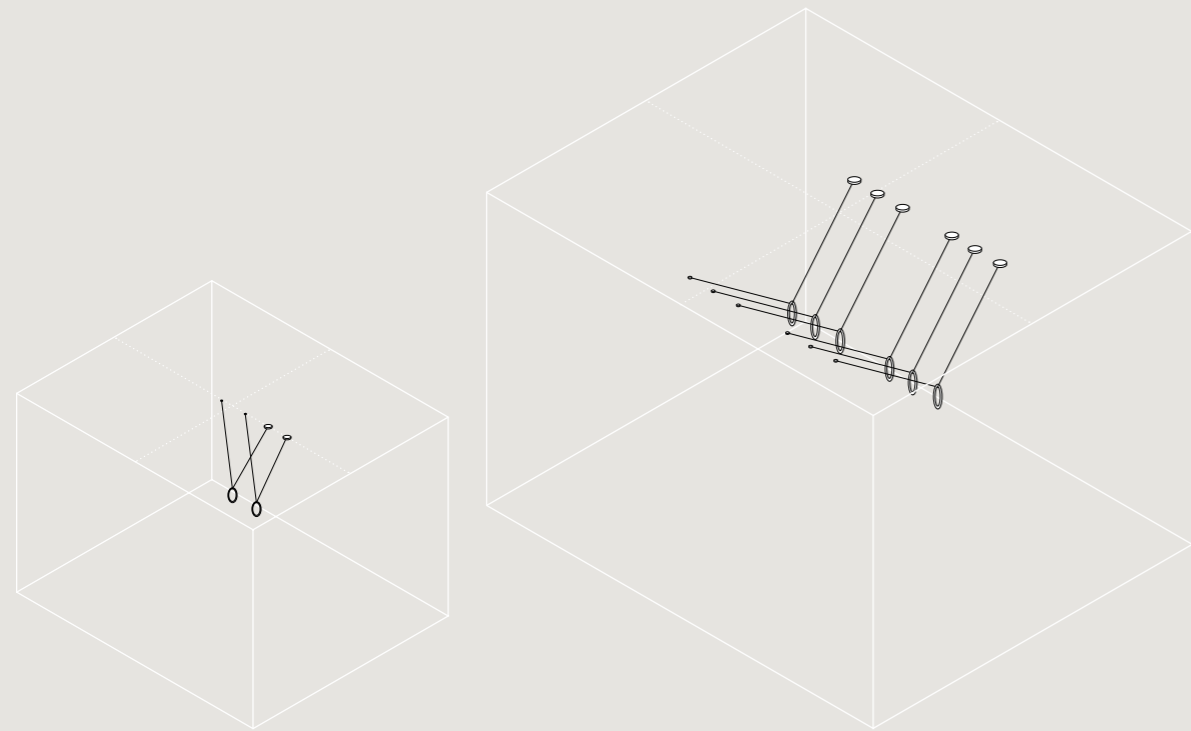
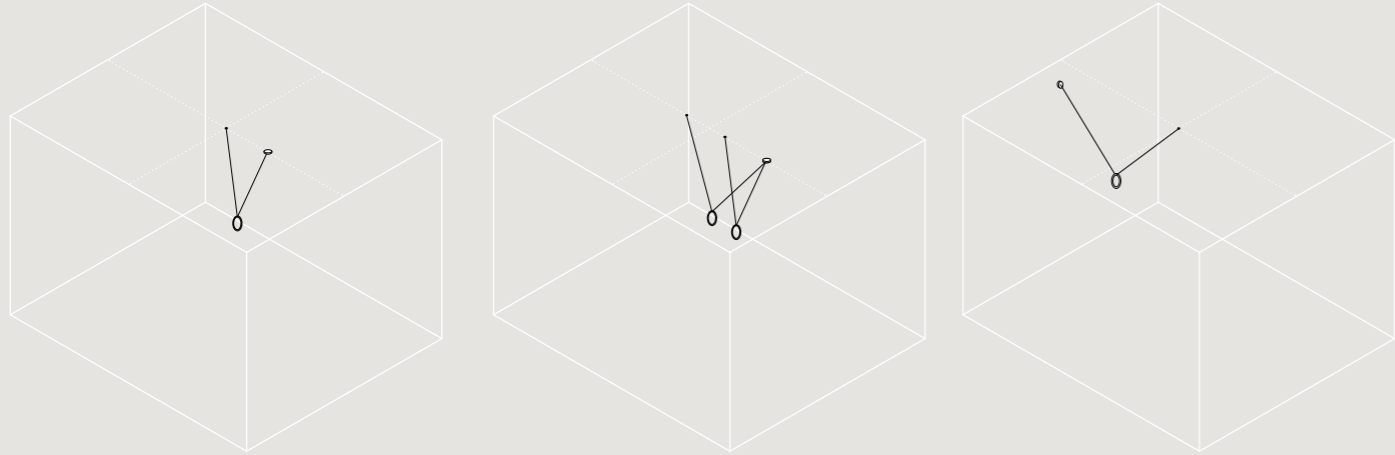

Central cluster suspension lamp

IVY V Examples of composition

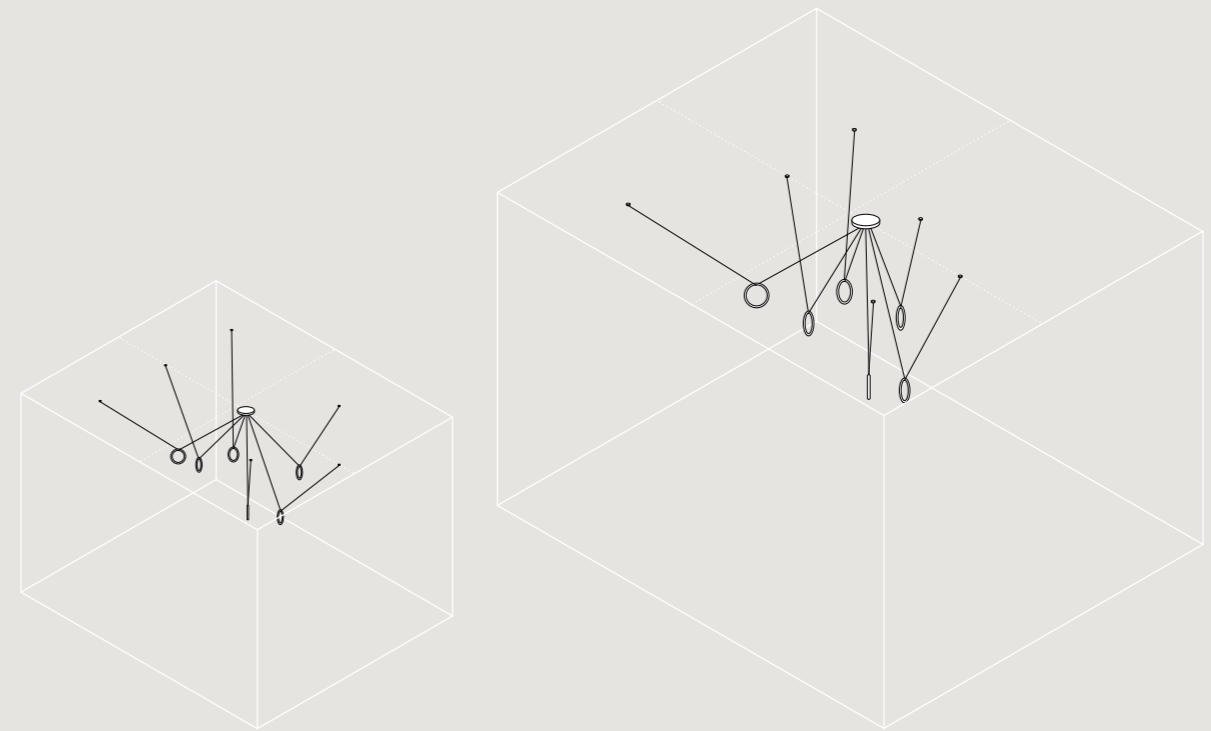
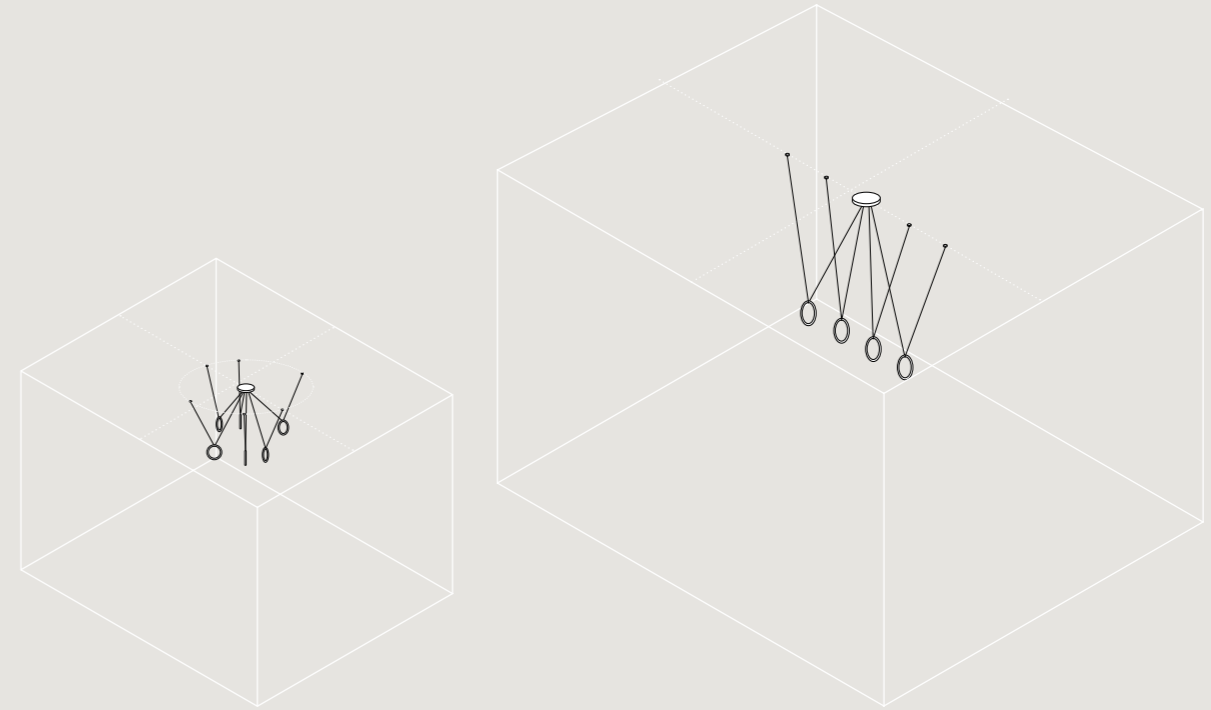

A–Tube Nano

A–Tube Nano is a suspension light which interprets light in its simplest form by creating a thin luminous line in the living spaces. At the lower end of the lightweight aluminium structure, a transparent methacrylate diffuser houses an LED module whose light creates a soft, welcoming atmosphere. The three sizes and seven statement finishes, including the new Terra, allow to create clusters of evocative lighting. Black cable version now available.

A–Tube Nano è una lampada a sospensione che interpreta la luce nella sua forma più essenziale disegnando una sottile linea luminosa nello spazio abitativo. All'estremità inferiore della leggera struttura in alluminio, un diffusore in metacrilato trasparente ospita un modulo LED la cui luce crea un'atmosfera morbida e avvolgente. Le tre dimensioni e le sette distinte finiture, con la nuova tonalità Terra, permettono di realizzare suggestive composizioni su cluster.

Cluster suspension lamp

A–Tube Nano small, medium and large,
composition of 5 lights on a *round canopy*,
FINISH Matte White

A–Tube Nano, *design by* Studio Italia Design, 2016





A-Tube Nano small, medium and large, special composition of 229 lights on *recessed micro canopies*

FINISHES Matte White, Chrome and Matte Champagne



A-Tube Nano large, *single mini canopies*,
FINISH Matte Champagne



A-*Tube Nano medium*, composition of 5 lights on a *round canopy*, FINISH Matte Black



A-*Tube Nano medium*, FINISH Matte Black



A-*Tube Nano* small, medium and large, composition of 14 lights on a *rectangular canopy*

FINISHES Matte Black and Chrome



A-Tube Nano small, medium and large, composition of 28 lights on a *rectangular canopy*, FINISHES Matte Black and Terra

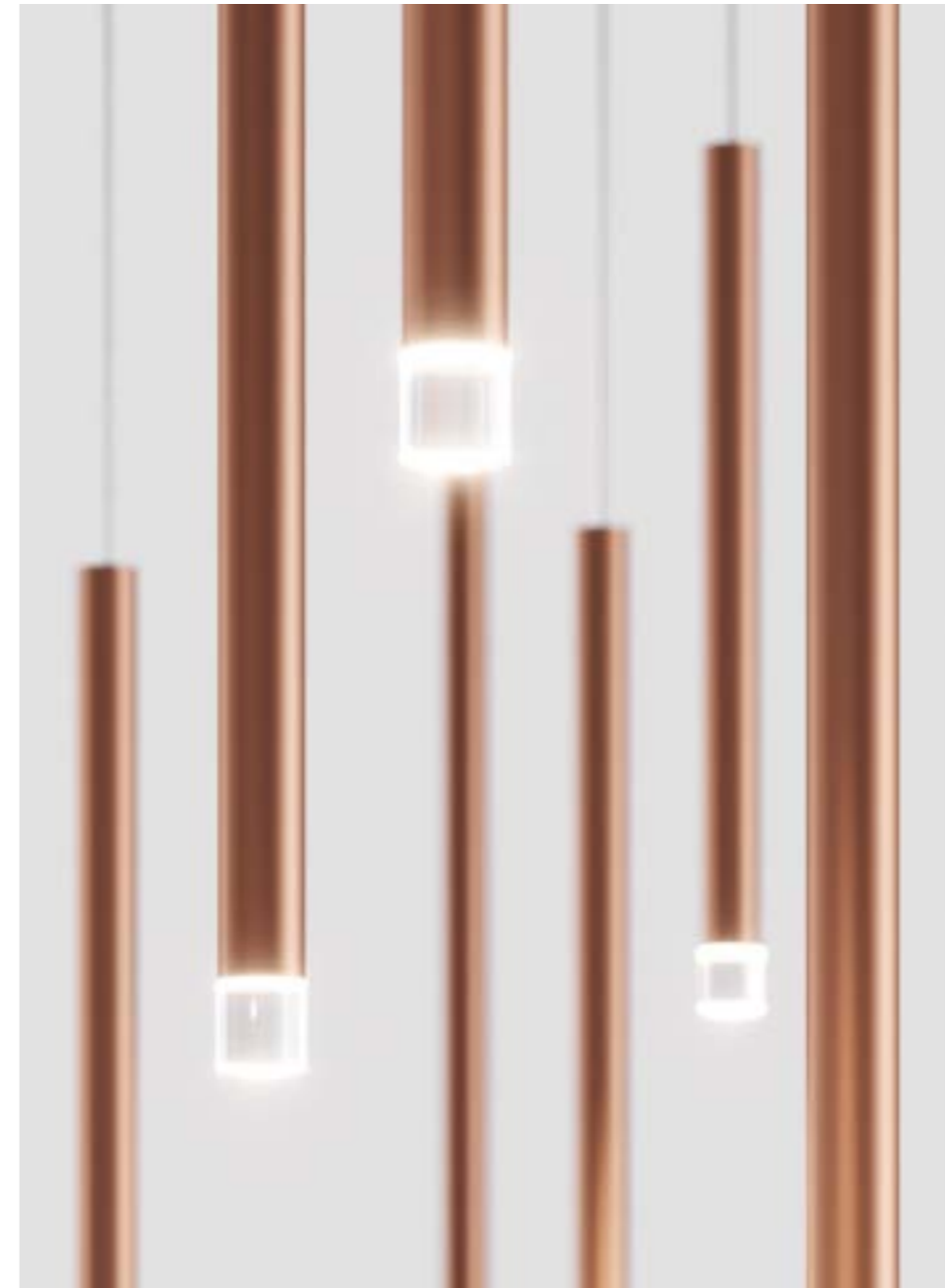

A-Tube Nano, FINISH Terra



A-Tube Nano est une suspension qui interprète la lumière dans sa forme la plus essentielle en dessinant une fine ligne lumineuse dans l'espace de vie. À l'extrémité inférieure de la structure en aluminium léger, un diffuseur en méthacrylate transparent abrite un module LED dont la lumière crée une atmosphère douce et enveloppante. Les trois dimensions et les sept finitions distinctes, dont la nouvelle Terra, permettent de créer des compositions suggestives en cluster. La version avec câble noir est maintenant disponible. ●FR

A-Tube Nano ist eine Hängeleuchte, die das Licht in seiner einfachsten Form interpretiert und für einen schmalen Lichtstreifen im Wohnraum sorgt. Am unteren Ende der leichten Armatur aus Aluminium enthält ein Diffusor aus Methacrylat ein LED-Modul, dessen Licht eine angenehme und umhüllende Atmosphäre entstehen lässt. Die drei Größen und sieben unterschiedlichen Ausführungen, darunter auch die neue Terra, ermöglichen die Umsetzung zauberhafter Kombinationen in Clustern. Schwarze Kabelversion jetzt verfügbar. ●DE

A-Tube Nano es una lámpara colgante que interpreta la luz en su forma más esencial distinguiendo una delgada línea luminosa en el espacio habitable. En el extremo inferior de la estructura ligera de aluminio, un difusor de metacrilato transparente acoge un módulo LED cuya luz crea una atmósfera suave y envolvente. Las tres dimensiones y los siete diferentes acabados, incluyendo el nuevo Terra, permiten realizar composiciones sugerativas en los grupos de lámparas colgantes. Ya está disponible la versión con cable negro. ●ES

A-Tube Nano – это подвесной светильник, который повторяет основную форму света, рисуя в жилом пространстве тонкую линию луча. В нижней части легкой алюминиевой конструкции в прозрачном диффузоре из метакрилата установлен светодиодный модуль, свет которого создает мягкую и обволакивающую атмосферу. Возможность выбора из трех размеров и шести различных отделок, включая новую тональность Terra, позволяет создавать потрясающие композиции на кластерах. Теперь доступна новая версия с черным кабелем. ●RU

A-Tube Nano是一款吊灯，以简约的形式诠释灯光，在居住空间中勾勒出纤细的光线。在轻盈的铝材结构下端，安装了透明的甲基丙烯酸酯灯罩，内置LED模块，灯光营造柔和温馨的气氛。三种尺寸和包含全新大地色调在内的六种颜色，可打造迷人的组合吊。黑色线缆版本现有供应。●ZH

Visit website:



A-Tube Nano small ▾ Cluster suspension lamp

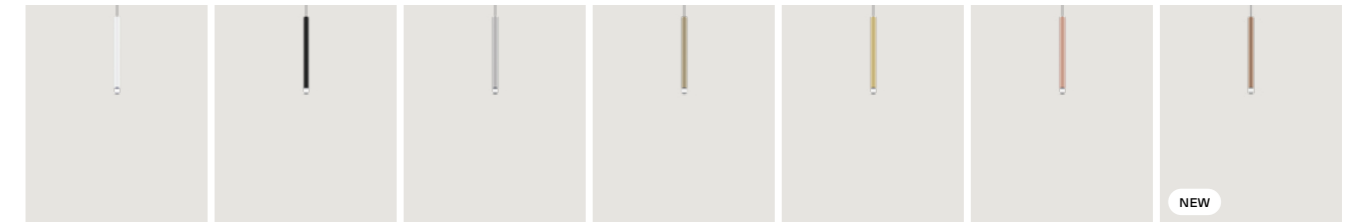

A-Tube Nano medium ▾ Cluster suspension lamp



A-Tube Nano large ▾ Cluster suspension lamp

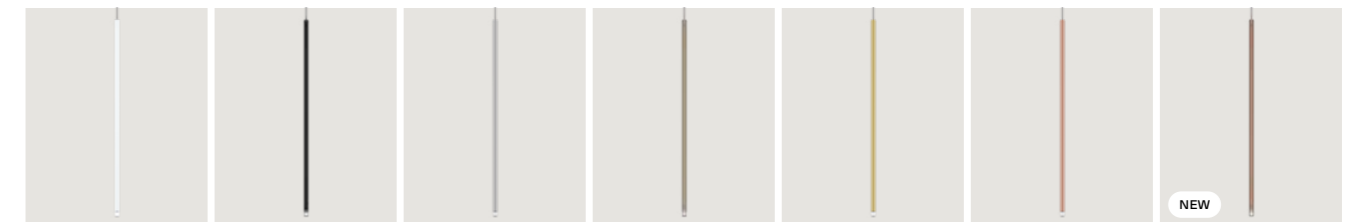

Transparent cable Black cable



A-Tube Nano small, medium and large, recessed micro canopies, FINISHES Gold and Rose Gold

A-Tube Nano, design by Studio Italia Design, 2016

Cluster suspension lamp

A-Tube Nano small



Light source Sorgente luminosa	Metal structure Montatura in metallo	Methacrylate diffuser Diffusore in metacrilato	Code Codice
LED ↘ 2700 K ↘ 3 W/450 lm ↘ 350 mA ↘ CRI 90 ↘ MacAdam 3-Step LED and driver included LED e driver inclusi	Matte White - 9010 Bianco Opaco - 9010		15822 1020
	Matte Black - 9005 Nero Opaco - 9005		15822 2020
	Chrome Cromo		15822 4020
	Matte Champagne Champagne Opaco	Clear Trasparente	15822 4520
	Gold Oro		15822 5020
	Rose Gold Oro Rosa		15822 5520
	Terra ^{NEW} Terra	Transparent cable Cavo Trasparente	15822 6720
	Matte White - 9010 Bianco Opaco - 9010		15826 1020
	Matte Black - 9005 Nero Opaco - 9005		15826 2020
	Chrome Cromo		15826 4020
LED ↘ 3000 K ↘ 3 W/480 lm ↘ 350 mA ↘ CRI 90 ↘ MacAdam 3-Step LED and driver included LED e driver inclusi	Matte Champagne Champagne Opaco	Clear Trasparente	15826 4520
	Gold Oro		15826 5020
	Rose Gold Oro Rosa		15826 5520
	Terra ^{NEW} Terra	Black cable Cavo Nero	15826 6720
	Matte White - 9010 Bianco Opaco - 9010		15822 1035
	Matte Black - 9005 Nero Opaco - 9005		15822 2035
	Chrome Cromo		15822 4035
	Matte Champagne Champagne Opaco	Clear Trasparente	15822 4535
	Gold Oro		15822 5035
	Rose Gold Oro Rosa		15822 5535
LED ↘ 3000 K ↘ 3 W/480 lm ↘ 350 mA ↘ CRI 90 ↘ MacAdam 3-Step LED and driver included LED e driver inclusi	Terra ^{NEW} Terra	Transparent cable Cavo Trasparente	15822 6735
	Matte White - 9010 Bianco Opaco - 9010		15826 1035
	Matte Black - 9005 Nero Opaco - 9005		15826 2035
	Chrome Cromo		15826 4035
	Matte Champagne Champagne Opaco	Clear Trasparente	15826 4535
	Gold Oro		15826 5035
	Rose Gold Oro Rosa		15826 5535
	Terra ^{NEW} Terra	Black cable Cavo Nero	15826 6735

Net weight/Peso netto: 0.25 kg

Pack/Colli: 2

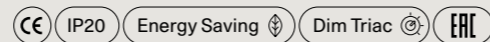

A-Tube Nano, design by Studio Italia Design, 2016

Cluster suspension lamp

A-Tube Nano medium

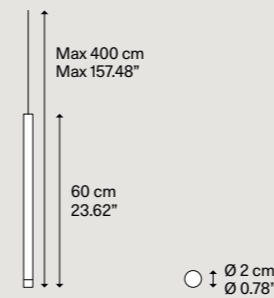

Light source Sorgente luminosa	Metal structure Montatura in metallo	Methacrylate diffuser Diffusore in metacrilato	Code Codice
LED ↘ 2700 K ↘ 3 W/450 lm ↘ 350 mA ↘ CRI 90 ↘ MacAdam 3-Step LED and driver included LED e driver inclusi	Matte White - 9010 Bianco Opaco - 9010		15823 1020
	Matte Black - 9005 Nero Opaco - 9005		15823 2020
	Chrome Cromo		15823 4020
	Matte Champagne Champagne Opaco	Clear Trasparente	15823 4520
	Gold Oro		15823 5020
	Rose Gold Oro Rosa		15823 5520
	Terra ^{NEW} Terra	Transparent cable Cavo Trasparente	15823 6720
	Matte White - 9010 Bianco Opaco - 9010		15827 1020
	Matte Black - 9005 Nero Opaco - 9005		15827 2020
	Chrome Cromo		15827 4020
LED ↘ 3000 K ↘ 3 W/480 lm ↘ 350 mA ↘ CRI 90 ↘ MacAdam 3-Step LED and driver included LED e driver inclusi	Matte Champagne Champagne Opaco	Clear Trasparente	15827 4520
	Gold Oro		15827 5020
	Rose Gold Oro Rosa		15827 5520
	Terra ^{NEW} Terra	Black cable Cavo Nero	15827 6720
	Matte White - 9010 Bianco Opaco - 9010		15823 1035
	Matte Black - 9005 Nero Opaco - 9005		15823 2035
	Chrome Cromo		15823 4035
	Matte Champagne Champagne Opaco	Clear Trasparente	15823 4535
	Gold Oro		15823 5035
	Rose Gold Oro Rosa		15823 5535
LED ↘ 3000 K ↘ 3 W/480 lm ↘ 350 mA ↘ CRI 90 ↘ MacAdam 3-Step LED and driver included LED e driver inclusi	Terra ^{NEW} Terra	Transparent cable Cavo Trasparente	15823 6735
	Matte White - 9010 Bianco Opaco - 9010		15827 1035
	Matte Black - 9005 Nero Opaco - 9005		15827 2035
	Chrome Cromo		15827 4035
	Matte Champagne Champagne Opaco	Clear Trasparente	15827 4535
	Gold Oro		15827 5035
	Rose Gold Oro Rosa		15827 5535
	Terra ^{NEW} Terra	Black cable Cavo Nero	15827 6735

Net weight/Peso netto: 0.3 kg

Pack/Colli: 2

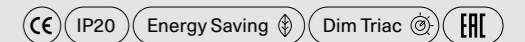

Cluster suspension lamp

A-*Tube Nano large*

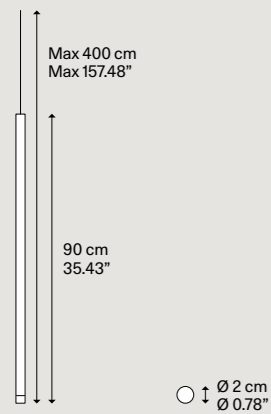

Light source Sorgente luminosa	Metal structure Montatura in metallo	Methacrylate diffuser Diffusore in metacrilato	Code Codice	
LED ≈ 2700 K ≈ 3 W/450 lm ≈ 350 mA ≈ CRI 90 ≈ MacAdam 3-Step LED and driver included LED e driver inclusi	Matte White - 9010 Bianco Opaco - 9010	Clear Trasparente	15824 1020	
	Matte Black - 9005 Nero Opaco - 9005		15824 2020	
	Chrome Cromo		15824 4020	
	Matte Champagne Champagne Opaco		15824 4520	
	Gold Oro		15824 5020	
	Rose Gold Oro Rosa		15824 5520	
	Terra ^{NEW} Terra		Transparent cable Cavo Trasparente	15824 6720
	Matte White - 9010 Bianco Opaco - 9010		15828 1020	
	Matte Black - 9005 Nero Opaco - 9005		15828 2020	
	Chrome Cromo		15828 4020	
	Matte Champagne Champagne Opaco		Clear Trasparente	15828 4520
	Gold Oro		15828 5020	
	Rose Gold Oro Rosa		15828 5520	
	Terra ^{NEW} Terra		Black cable Cavo Nero	15828 6720
LED ≈ 3000 K ≈ 3 W/480 lm ≈ 350 mA ≈ CRI 90 ≈ MacAdam 3-Step LED and driver included LED e driver inclusi	Matte White - 9010 Bianco Opaco - 9010	Clear Trasparente	15824 1035	
	Matte Black - 9005 Nero Opaco - 9005		15824 2035	
	Chrome Cromo		15824 4035	
	Matte Champagne Champagne Opaco		15824 4535	
	Gold Oro		15824 5035	
	Rose Gold Oro Rosa		15824 5535	
	Terra ^{NEW} Terra		Transparent cable Cavo Trasparente	15824 6735
	Matte White - 9010 Bianco Opaco - 9010		15828 1035	
	Matte Black - 9005 Nero Opaco - 9005		15828 2035	
	Chrome Cromo		15828 4035	
	Matte Champagne Champagne Opaco		Clear Trasparente	15828 4535
	Gold Oro		15828 5035	
	Rose Gold Oro Rosa		15828 5535	
	Terra ^{NEW} Terra		Black cable Cavo Nero	15828 6735

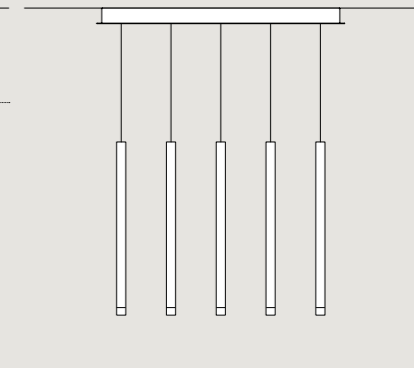
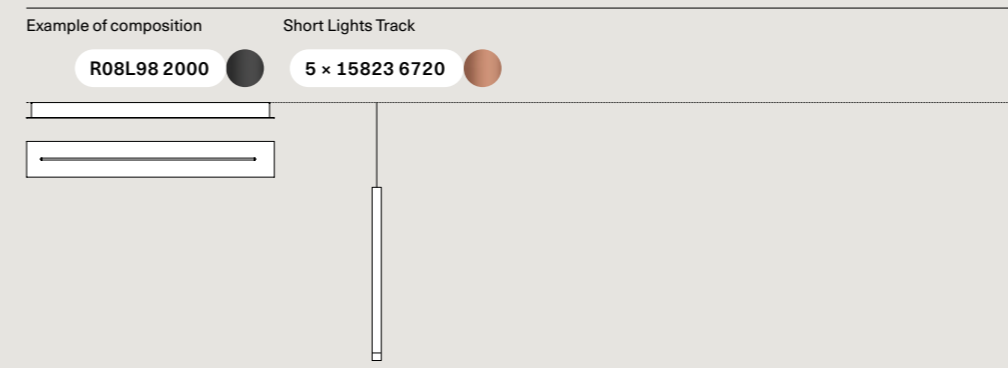
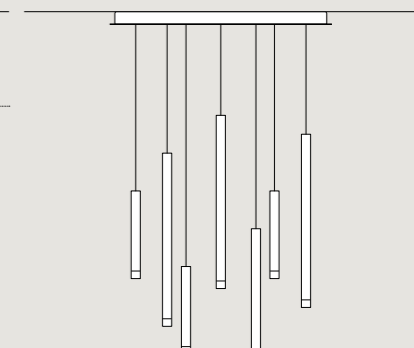
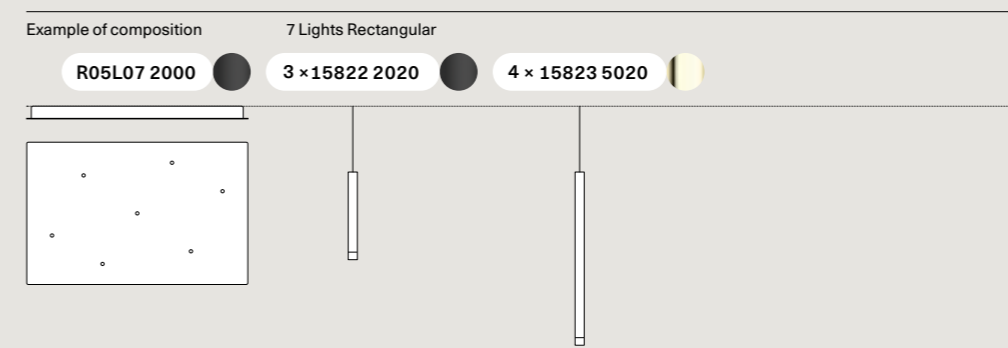
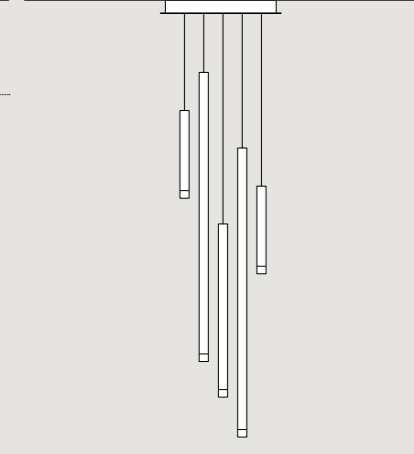
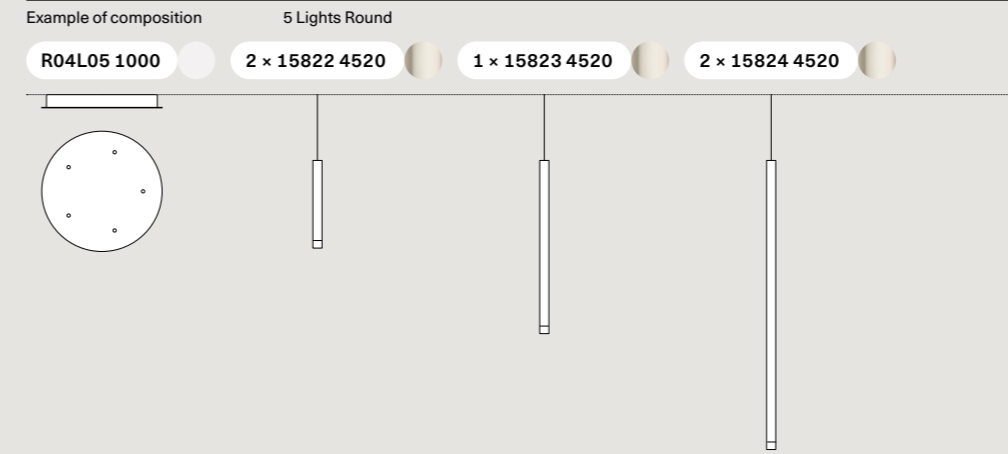

Suspension lamps must be installed on a canopy ▶ pag. 396-403
Le lampade a sospensione devono essere installate su rosone ▶ pag. 396-403

Net weight/Peso netto: 0.59 kg Pack/Colli: 2

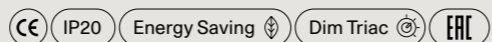

A-Tube Nano Duo

Precious pins suspended from a thin cable, like magic lights floating in the space. A-Tube Nano Duo is an offshoot of A-Tube Nano with an LED light source on both ends of its thin metal body. A lightweight and linear lamp available in six finishes, which allows to create evocative and playful cluster compositions.

Preziose barrette sospese ad un cavo sottile, come magiche luci che galleggiano nello spazio. A-Tube Nano Duo è una variante di A-Tube Nano con sorgente luminosa a LED su entrambe le estremità del sottile corpo metallico. Una lampada leggera e lineare disponibile in sei finiture, con le quali si possono realizzare suggestive e giocose composizioni su cluster.

Cluster suspension lamp

A-Tube Nano Duo, composition of 7 lights on a *round canopy*, FINISHES Chrome and Matte Black

A-Tube Nano Duo, *design by* Studio Italia Design, 2017

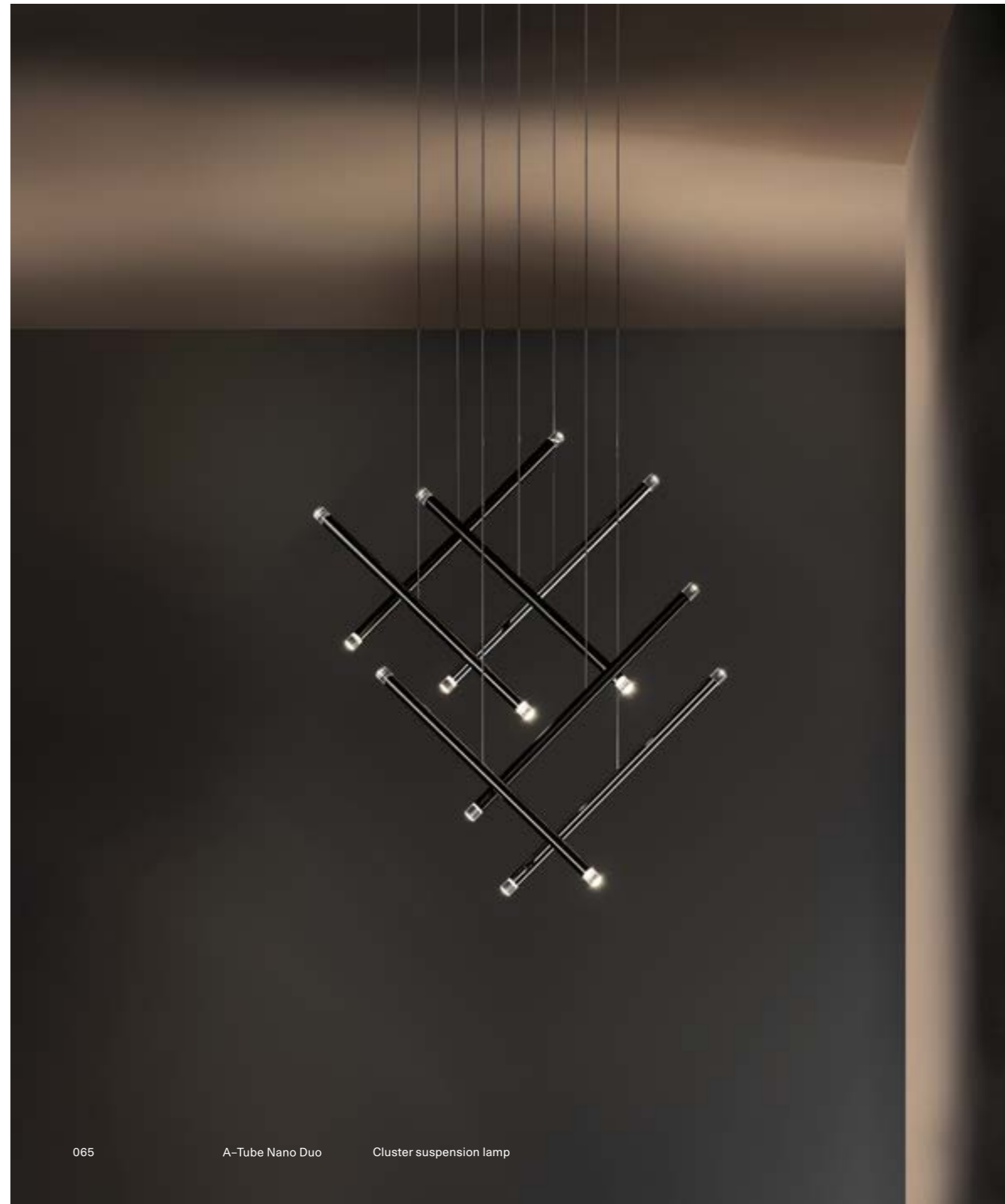

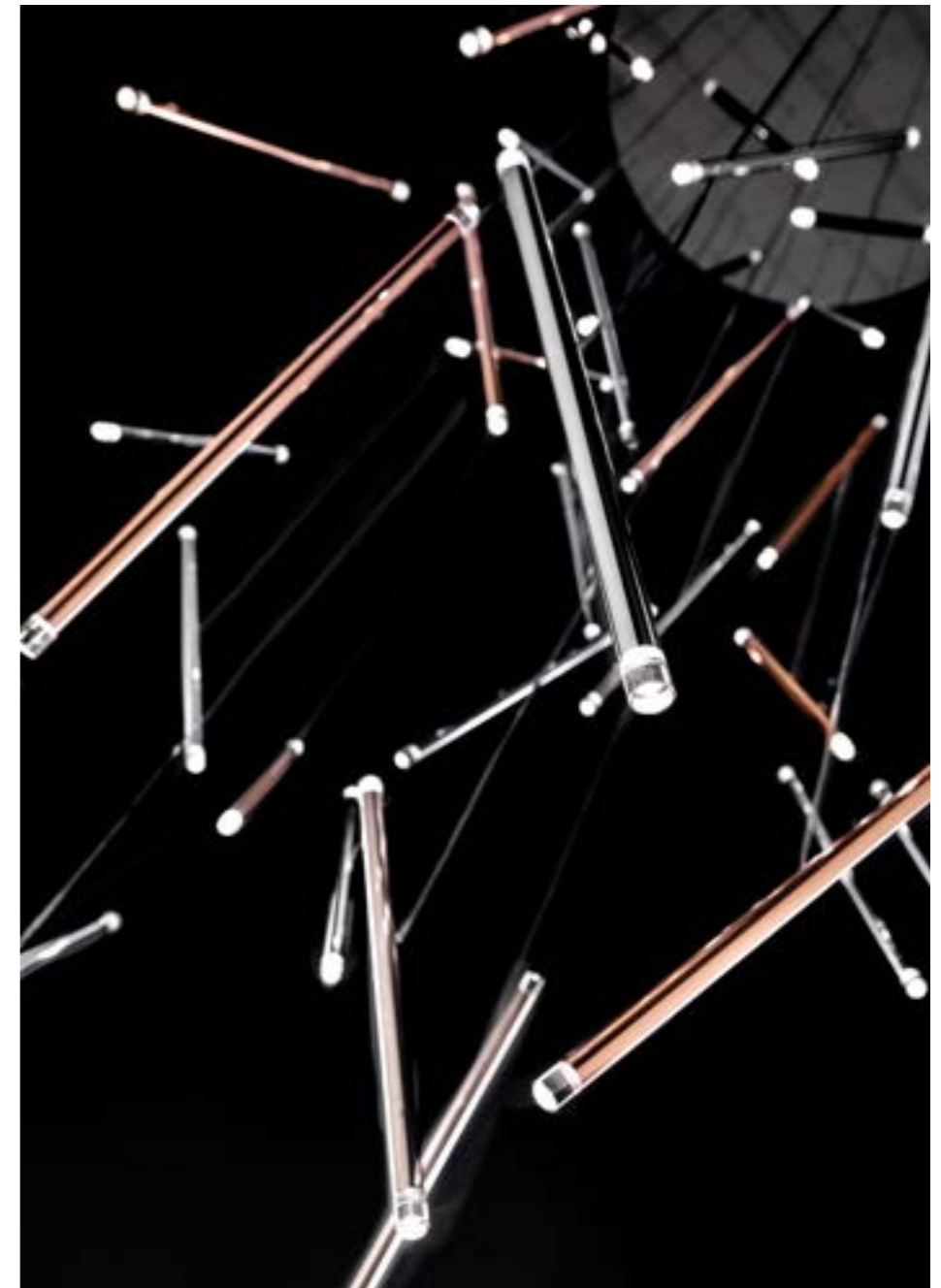

A-Tube Nano Duo, FINISHES Chrome and Rose Gold

A-Tube Nano Duo, composition of 36 lights on a *round canopy*, FINISH Matte Champagne



A-Tube Nano Duo, compositions of 24 lights
on a *round canopy*, FINISHES Matte White and Gold



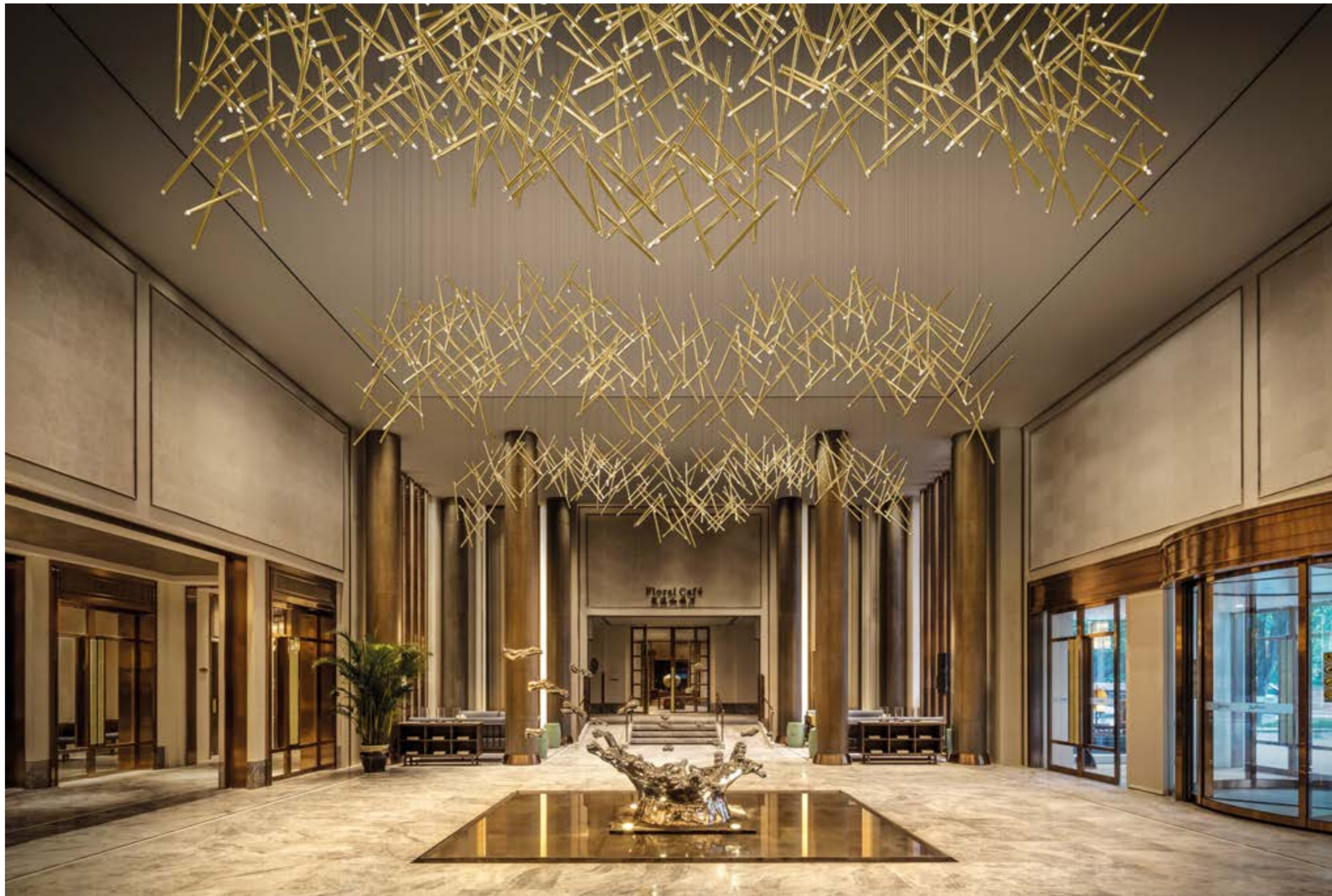

A-Tube Nano Duo, special composition, FINISH Gold

De précieuses barres suspendues à un câble fin, comme des lumières magiques flottant dans l'espace. A-Tube Nano Duo est une variante de A-Tube Nano avec une source de lumière LED aux deux extrémités du fin corps métallique. Une lampe légère et linéaire disponible en six finitions, avec laquelle on peut créer des compositions multiples évocatrices et ludiques. ● FR

Wertvolle Balken, die an einem schmalen Kabel hängen, wie magisches Licht, das im Raum schwebt. A-Tube Nano Duo ist eine Variante von A-Tube Nano mit LED-Lichtquelle an beiden Enden des dünnen Metallkorpus. Eine leichte und lineare Leuchte, in sechs Ausführungen verfügbar, mit denen wunderbare und verspielte Cluster-Kombinationen geschaffen werden können. ● DE

Preciosas barras suspendidas de un cable delgado, como luces mágicas flotando en el espacio. A-Tube Nano Duo es una variante de A-Tube Nano con fuente luminosa LED en ambos extremos del fino cuerpo de metal. Una lámpara ligera y lineal disponible en seis acabados, con la que se pueden crear sugestivas y divertidas composiciones en grupos de lámparas colgantes. ● ES

Изящные трубки, подвешенные на тонком кабеле, – словно волшебные огни, парящие в пространстве. Светильник A-Tube Nano Duo является вариантом A-Tube Nano с источником света LED на обоих концах тонкого металлического корпуса. Легкая прямолинейная лампа доступна в шести вариантах отделки, с использованием которых можно создавать очаровательные и живые кластерные композиции. ● RU

通过细细的电缆线将贵重的条形悬挂起来，就像漂浮在太空中的魔幻灯一样。A-Tube Nano Duo是A-Tube Nano的变型，在纤薄金属主体的两端均带有LED光源。这是一种轻巧的线性灯，有六种颜色，可以在组合吊上创建富有启发性和趣味性的构造。● ZH

Visit website:



A-Tube Nano Duo, design by Studio Italia Design, 2017

Cluster suspension lamp

A-Tube Nano Duo

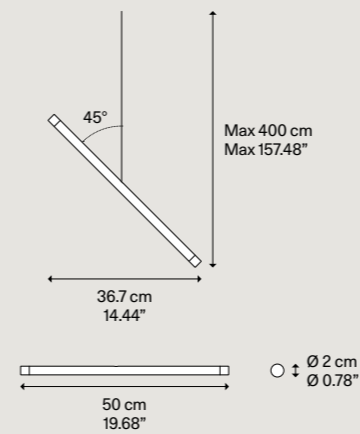

Light source
Sorgente luminosa

LED
 ↳ 2700 K
 ↳ 2 x 1 W/300 lm
 ↳ 350 mA
 ↳ CRI 90
 ↳ MacAdam 3-Step

LED and driver included
LED e driver inclusi

Metal structure
Montatura in metallo

- Matte White – 9010
Bianco Opaco – 9010
- Matte Black – 9005
Nero Opaco – 9005
- Chrome
Cromo
- Matte Champagne
Champagne Opaco
- Gold
Oro
- Rose Gold
Oro Rosa

Methacrylate diffuser
Diffusore in metacrilato

- Clear
Trasparente

Code
Codice

- 15825 1020
- 15825 2020
- 15825 4020
- 15825 4520
- 15825 5020
- 15825 5520

Net weight/Peso netto: 0.21 kg

Pack/Colli: 1

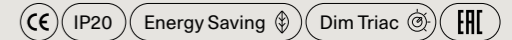

Suspension lamps must be installed on a canopy ► pag. 396–403
Le lampade a sospensione devono essere installate su rosone ► pag. 396–403

Example of composition

5 Lights Round

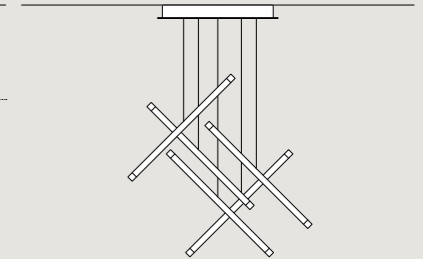
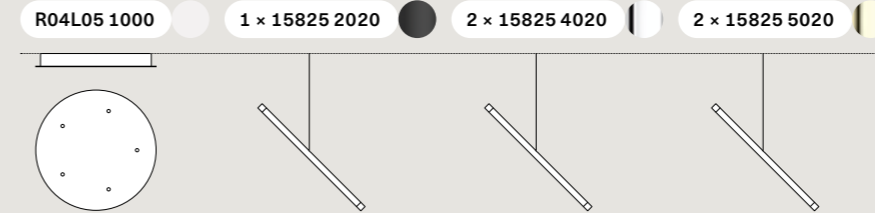

Example of composition

7 Lights Rectangular

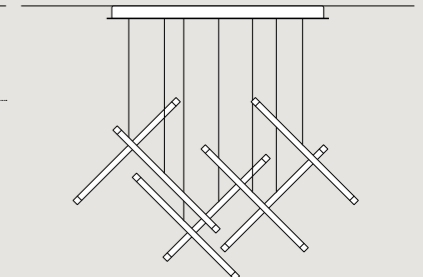
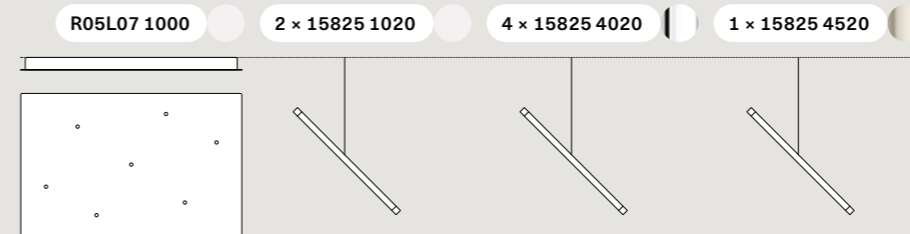

A-Tube Nano Duo ► Cluster suspension lamp



A-Tube

A simple form that delivers the light to wherever it's needed, enhancing the space. Tubular and slim, A-Tube is a versatile lamp available in four different sizes and three finishes. It can be fixed directly to the ceiling, suspended singularly, or used in cluster compositions to create impactful lighting effects.

Una forma semplice, che porta la luce dove si desidera valorizzando l'ambiente. Tubolare e sottile, A-Tube è una lampada versatile, disponibile in diverse dimensioni e in tre finiture. Può essere fissata direttamente al soffitto, sospesa singolarmente, oppure utilizzata in composizioni cluster d'effetto.

Cluster suspension lamp, Ceiling lamp

A-Tube medium, small and large,
composition of 3 lights on a *round canopy*,
FINISH Matte White

A-Tube, *design by* Studio Italia Design, 2013





A-Tube small and large, FINISH Matte Black



A-Tube medium, composition of 3 lights on a *long track*, FINISH Coppery Bronze

A-Tube mini, FINISH Matte White

Une forme simple, qui éclaire où vous le souhaitez tout en valorisant l'environnement. Tubulaire et fine, A-Tube est une lampe polyvalente, disponible en différentes dimensions et trois finitions. Elle peut être fixée directement au plafond, suspendue individuellement ou utilisée en compositions cluster. ●FR

Eine einfache Form, die das Licht in jenen Bereich des Raums bringt, der betont werden soll. Röhrenförmig und dünn, ist A-Tube eine vielseitige Lampe, die in verschiedenen Größen und drei Ausführungen verfügbar ist. Sie kann direkt an der Decke befestigt werden, einzeln hängend, oder zu wirkungsvollen Clustern kombiniert. ●DE

Una forma simple, que lleva la luz donde se desea valorizando el ambiente. Tubular y sutil, la A-Tube es una lámpara versátil, disponible en diferentes tamaños y tres acabados. Puede fijarse directamente al techo, suspenderse individualmente o utilizarse en composiciones de grupos de lámparas colgantes de efecto. ●ES

Простая незамысловатая форма, несущая свет туда, где это необходимо, и украшающая интерьер. Светильник A-Tube в форме тонкой изящной трубки является необыкновенно универсальным и доступен с разными размерами и с тремя типами отделки. Его можно крепить непосредственно к потолку, повесить отдельно или использовать в качестве эффектных кластерных композиций. ●RU

外形简洁，可将光线照射到想要的地方。A-Tube呈管状且细长，是一种多功能灯，有不同尺寸和三种颜色可供选择。它可以直接吸顶安装，可以单独悬吊安装，也可以组合吊式安装。●ZH

Visit website:



A-Tube mini ↘ Ceiling lamp

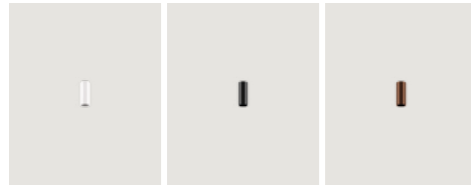

A-Tube small ↘ Ceiling lamp

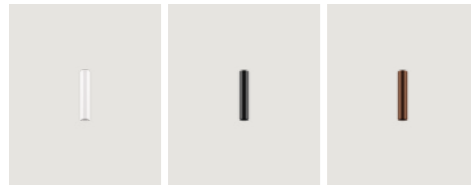

A-Tube small ↘ Cluster suspension lamp



A-Tube medium ↘ Ceiling lamp

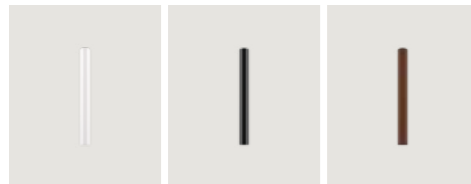

A-Tube medium ↘ Cluster suspension lamp



A-Tube large ↘ Ceiling lamp



A-Tube large ↘ Cluster suspension lamp



A-Tube, design by Studio Italia Design, 2013

Ceiling lamp

A-Tube mini



Light source
Sorgente luminosa

GU10 Par 16
↘ 1 × max 40W eco III

or

GU10 Par 16 LED
↘ 1 × 10 W III
W/L max 9 cm
W/L max 3.54"

Bulb not included
Lampadina non inclusa

Metal structure
Montatura in metallo

● Matte White - 9010
Bianco Opaco - 9010

● Matte Black - 9005
Nero Opaco - 9005

● Coppery Bronze
Bronzo Ramato

Code
Codice

09631 1000

09631 2000

09631 3500

Net weight/Peso netto: 0.2 kg

Pack/Colli: 1

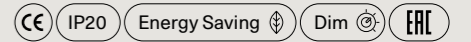

A-Tube small

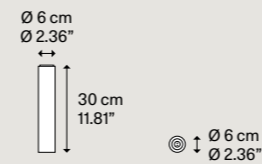

GU10 Par 16
↘ 1 × max 40W eco III

or

GU10 Par 16 LED
↘ 1 × 10 W III
W/L max 9 cm
W/L max 3.54"

Bulb not included
Lampadina non inclusa

● Matte White - 9010
Bianco Opaco - 9010

● Matte Black - 9005
Nero Opaco - 9005

● Coppery Bronze
Bronzo Ramato

09632 1000

09632 2000

09632 3500

Net weight/Peso netto: 0.8 kg

Pack/Colli: 1

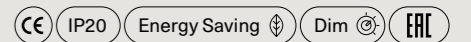

A-Tube medium

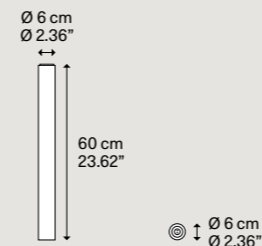

GU10 Par 16
↘ 1 × max 40W eco III

or

GU10 Par 16 LED
↘ 1 × 10 W III
W/L max 9 cm
W/L max 3.54"

Bulb not included
Lampadina non inclusa

● Matte White - 9010
Bianco Opaco - 9010

● Matte Black - 9005
Nero Opaco - 9005

● Coppery Bronze
Bronzo Ramato

09633 1000

09633 2000

09633 3500

Net weight/Peso netto: 0.9 kg

Pack/Colli: 1

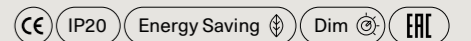

A-Tube large

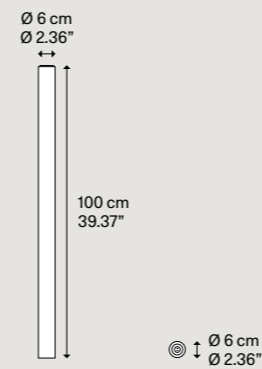

GU10 Par 16
↘ 1 × max 40W eco III

or

GU10 Par 16 LED
↘ 1 × 10 W III
W/L max 9 cm
W/L max 3.54"

Bulb not included
Lampadina non inclusa

● Matte White - 9010
Bianco Opaco - 9010

● Matte Black - 9005
Nero Opaco - 9005

● Coppery Bronze
Bronzo Ramato

09634 1000

09634 2000

09634 3500

Net weight/Peso netto: 1.5 kg

Pack/Colli: 1

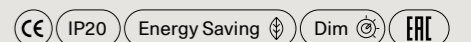

A-*Tube*, design by Studio Italia Design, 2013

Cluster suspension lamp

A-*Tube* small

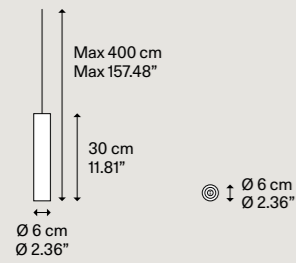

Net weight/Peso netto: 1.12 kg

Pack/Colli: 1

Light source
Sorgente luminosa

GU10 Par 16
≈ 1 × max 40W eco III



or
GU10 Par 16 LED
≈ 1 × 10 W III
W/L max 8.5 cm
W/L max 3.34"

Bulb not included
Lampadina non inclusa

Metal structure
Montatura in metallo

● Matte White - 9010
Bianco Opaco - 9010

● Matte Black - 9005
Nero Opaco - 9005

● Coppery Bronze
Bronzo Ramato

Code
Codice

09622 1000

09622 2000

09622 3500

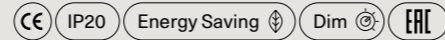

A-*Tube* medium

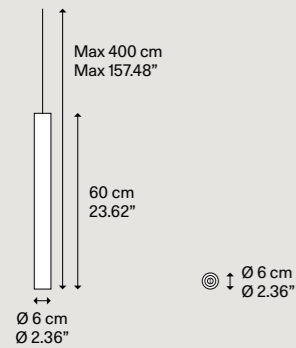

Net weight/Peso netto: 1.42 kg

Pack/Colli: 1

GU10 Par 16
≈ 1 × max 40W eco III



or
GU10 Par 16 LED
≈ 1 × 10 W III
W/L max 8.5 cm
W/L max 3.34"

Bulb not included
Lampadina non inclusa

● Matte White - 9010
Bianco Opaco - 9010

● Matte Black - 9005
Nero Opaco - 9005

● Coppery Bronze
Bronzo Ramato

09623 1000

09623 2000

09623 3500

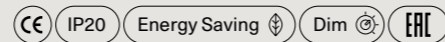

A-*Tube* large

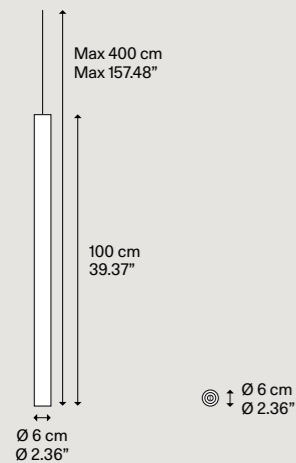

Net weight/Peso netto: 1.87 kg

Pack/Colli: 1

GU10 Par 16
≈ 1 × max 40W eco III



or
GU10 Par 16 LED
≈ 1 × 10 W III
W/L max 8.5 cm
W/L max 3.34"

Bulb not included
Lampadina non inclusa

● Matte White - 9010
Bianco Opaco - 9010

● Matte Black - 9005
Nero Opaco - 9005

● Coppery Bronze
Bronzo Ramato

09624 1000

09624 2000

09624 3500

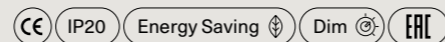

Suspension lamps must be installed on a canopy ► pag. 396-405
Le lampade a sospensione devono essere installate su rosone ► pag. 396-405

A-*Tube*, design by Studio Italia Design, 2013

Example of composition

5 Lights Round

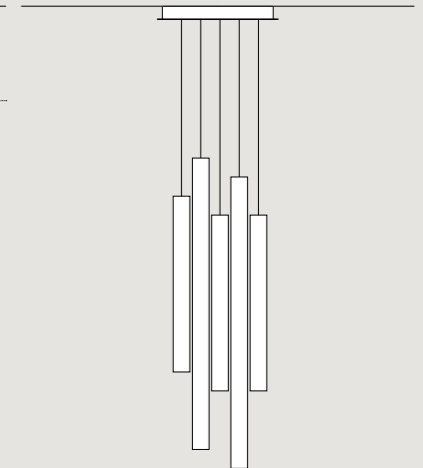
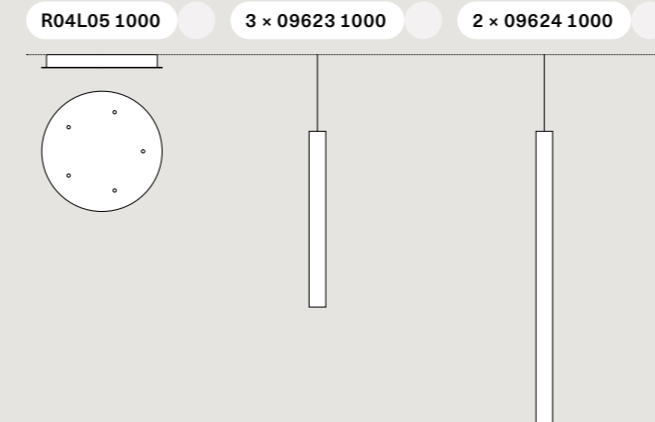

Example of composition

7 Lights Rectangular

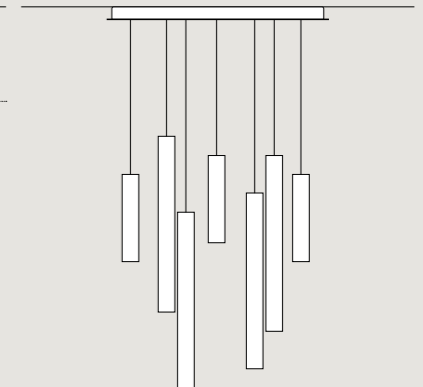
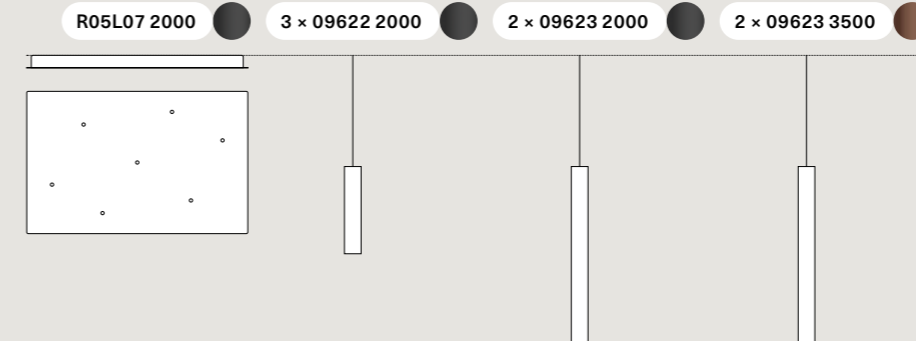

Example of composition

Short Lights Track

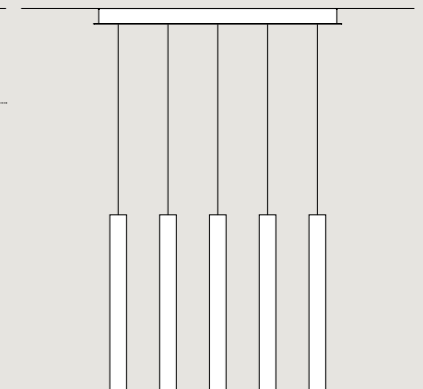
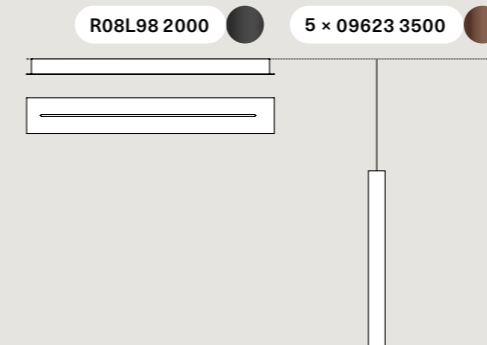

Rain

Rain falls from the ceiling like a drop of spring rain, with a linear movement that accentuates the curvaceous conical forms of its body. A metal suspension lamp with an LED light source – simple and effective, elegant and extremely bright, to be used either independently or as a scenic composition.

Rain scende dal soffitto come una goccia di pioggia primaverile, con un movimento lineare che accentua le sinuose forme coniche del suo corpo. Una sospensione in metallo con sorgente luminosa a LED – semplice ed efficace, elegante ed estremamente luminosa, da usare da sola o in composizioni scenografiche.

Cluster suspension lamp

Rain, FINISHES Matte Black + Matte Black
and Matte Black + Coppery Bronze

Rain, *design by* Andrea Tosetto, 2015





Rain, FINISHES Chrome + Brushed Chrome and Chrome + Rose Gold

Rain, composition of 24 lights
on a *round canopy*



Rain, special composition of 287 lights
on recessed micro canopies, FINISH Matte
Black + Gold



Rain, FINISH Chrome + Brushed Chrome

Rain, composition of 3 lights on a *short track*,
FINISH Chrome + Coppery Bronze



Rain, composition of 5 lights on a *round canopy* and single lights on *recessed micro canopies*

FINISHES Matte Black + Matte Black and Matte Black + Brushed Chrome



Rain, FINISH Chrome + Matte Black

Rain, une goutte de pluie printanière descend du plafond, avec un mouvement linéaire qui accentue les sinueuses formes coniques de son corps. Une suspension en métal avec source lumineuse LED – simple et efficace, élégante et très lumineuse, à utiliser seule ou en compositions scénographiques. ●FR

Rain kommt von der Decke herab wie ein Regentropfen im Frühling, mit einer linearen Bewegung, die die geschwungenen, konischen Formen des Korpus betont. Eine Aufhängung aus Metall mit LED-Lichtquelle, einfach und effizient, elegant und besonders stark leuchtend, einzeln oder in wirkungsvollen Kombinationen zu verwenden. ●DE

Rain cae como una gota de lluvia primaveral del techo, con un movimiento lineal que acentúa las sinuosas formas cónicas de su cuerpo. Colgante de metal con fuente luminosa LED, simple y efectiva, elegante y extremadamente brillante, para usarla sola o en composiciones escénicas. ●ES

Светильник Rain спускается с потолка подобно капле весеннего дождя, прямолинейность падения которой оттеняет изгибы конических форм его корпуса. Металлический подвесной светильник с источником света LED – простой и эффективный, элегантный и необыкновенно яркий, для использования отдельно или в композициях со сценическим эффектом. ●RU

Rain就如从天花板上滴下的一滴春雨，以线性运动加重了其主体的弯曲圆锥形的外形。具有LED光源的金属悬架简单有效，优雅且非常明亮，可单独使用或在场景中组合使用。●ZH

Visit website:



Rain ▾ Cluster suspension lamp

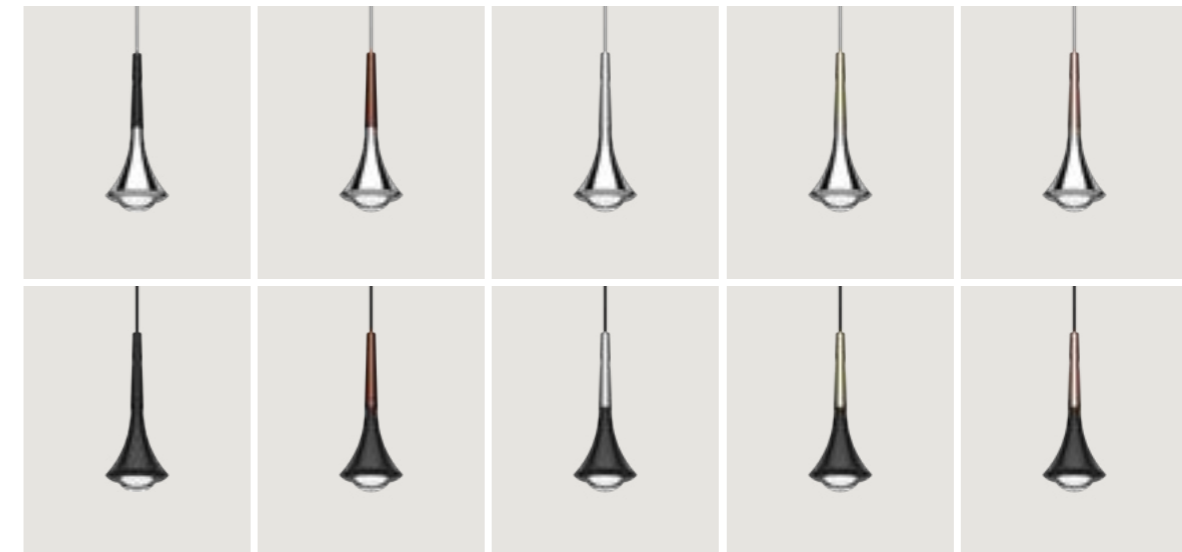

Cluster suspension lamp

Rain

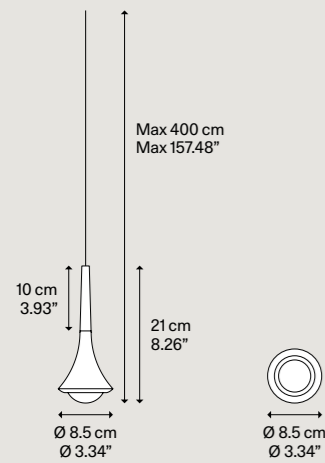

Light source Sorgente luminosa	Metal structure Montatura in metallo	Metal decor Decoro in metallo	Code Codice
LED ↗ 2700 K ↗ 7.2 W/830 lm ↗ 220-240 V ↗ CRI 92 ↗ MacAdam 3-Step	Transparent cable Cavo Trasparente	Matte Black - 9005 Nero Opaco - 9005	15621 2027
		Coppery Bronze Bronzo Ramato	15621 3527
LED included LED incluso	Black cable Cavo Nero	Brushed Chrome Cromo Spazzolato	15621 4727
		Gold Oro	15621 5027
LED ↗ 3000 K ↗ 7.2 W/860 lm ↗ 220-240 V ↗ CRI 92 ↗ MacAdam 3-Step	Transparent cable Cavo Trasparente	Rose Gold Oro Rosa	15621 5527
		Matte Black - 9005 Nero Opaco - 9005	15622 2027
LED included LED incluso	Black cable Cavo Nero	Coppery Bronze Bronzo Ramato	15622 3527
		Brushed Chrome Cromo Spazzolato	15622 4727
LED ↗ 3000 K ↗ 7.2 W/860 lm ↗ 220-240 V ↗ CRI 92 ↗ MacAdam 3-Step	Transparent cable Cavo Trasparente	Gold Oro	15622 5027
		Rose Gold Oro Rosa	15622 5527
LED included LED incluso	Black cable Cavo Nero	Matte Black - 9005 Nero Opaco - 9005	15621 2030
		Coppery Bronze Bronzo Ramato	15621 3530
LED ↗ 3000 K ↗ 7.2 W/860 lm ↗ 220-240 V ↗ CRI 92 ↗ MacAdam 3-Step	Transparent cable Cavo Trasparente	Brushed Chrome Cromo Spazzolato	15621 4730
		Gold Oro	15621 5030
LED included LED incluso	Black cable Cavo Nero	Rose Gold Oro Rosa	15621 5530
		Matte Black - 9005 Nero Opaco - 9005	15622 2030
LED ↗ 3000 K ↗ 7.2 W/860 lm ↗ 220-240 V ↗ CRI 92 ↗ MacAdam 3-Step	Transparent cable Cavo Trasparente	Coppery Bronze Bronzo Ramato	15622 3530
		Brushed Chrome Cromo Spazzolato	15622 4730
LED included LED incluso	Black cable Cavo Nero	Gold Oro	15622 5030
		Rose Gold Oro Rosa	15622 5530

Net weight/Peso netto: 0.34 kg

Pack/Colli: 2

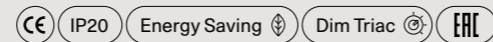

Suspension lamps must be installed on a canopy ▶ pag. 396-405
Le lampade a sospensione devono essere installate su rosone ▶ pag. 396-405

LED sources with direct power supply to the AC line voltage - driver not required. Dimmable with phase cut dimmer.

LED con alimentazione diretta a tensione di rete - non necessita di driver. Dimmerabile con varialuce a taglio di fase.

Example of composition

Short Lights Track

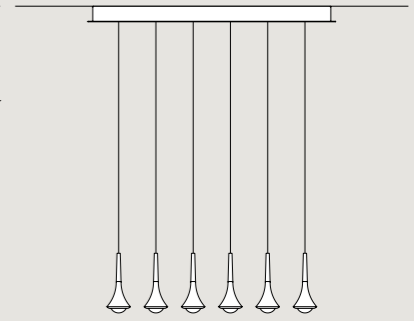
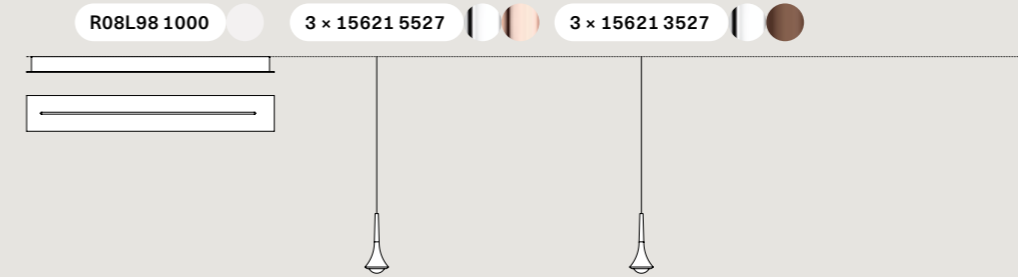

Example of composition

7 Lights Round

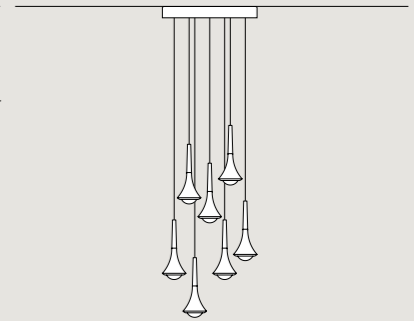
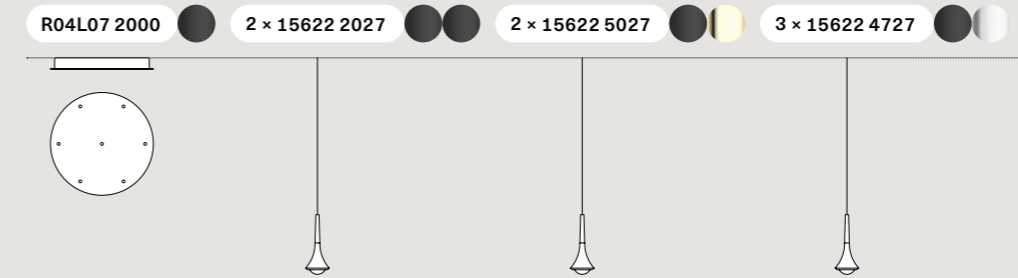

Example of composition

12 Lights Radial

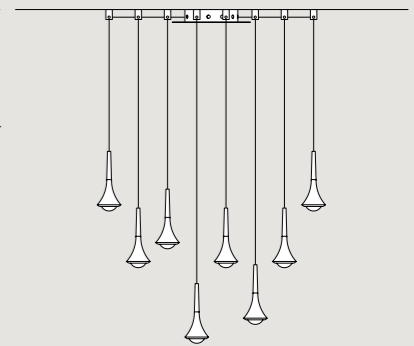
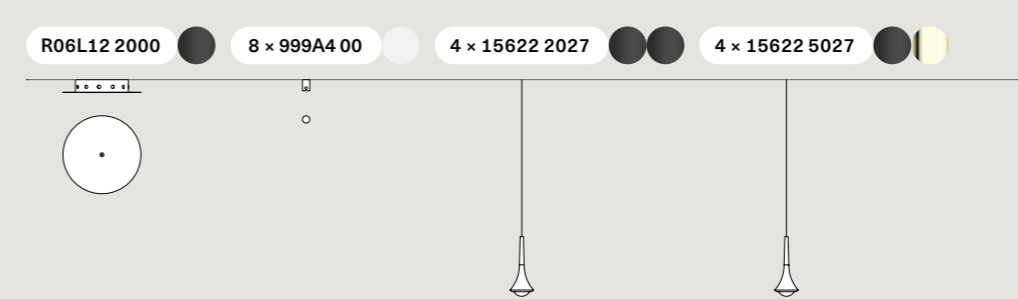

Spider

Spider is a round suspension lamp resembling an eye that can look into any part of the room. By adjusting the angle of the diffuser, the light beam emitted by the LED light can be directed towards any specific point. When installed on the different clusters available, it can create numerous lighting patterns, from functional to decorative, which can be dimmed at will. Now available in the new Terra finish and as ceiling light. In Spider, the simplicity of the looks underscores the versatility of its performance.

Spider è una lampada a sospensione sferica che ricorda un occhio che può guardare in qualsiasi punto della stanza. Regolando l'angolo del diffusore si può infatti dirigere il fascio di luce a LED su un particolare punto di interesse, mentre montata sui diversi cluster disponibili può creare molteplici schemi di luce, dal funzionale al decorativo, dimmerabili a piacere. Disponibile ora nella nuova finitura Terra e nella versione a soffitto. In Spider, la semplicità della forma esalta la versatilità delle prestazioni.

Cluster suspension lamp, Ceiling lamp

Spider,
FINISHES Terra and Matte Black

Spider, *design by* Studio Italia Design, 2015/2022





Spider, FINISH Matte Black

1, 2



3, 4



1/4-Spider,
FINISHES Matte White, Matte Black,
Matte Champagne and Terra



Spider, FINISH Matte Black



Spider, FINISHES Terra
and Matte Black

CENTRE: composition of
4 lights on a *radial canopy*

SIDES: single lights on
wall-mounted radial canopies



Spider, composition of 7 lights on a *round canopy*, FINISH Matte Black



Spider, *recessed micro canopy*, FINISH Rose Gold



Spider, composition of 10 lights on a *radial canopy*, FINISH Matte White



Spider, composition of 6 lights on a radial canopy, FINISH Matte Champagne

Spider est une suspension sphérique qui fait penser à un œil qui peut regarder n'importe où dans la pièce. En réglant l'angle du diffuseur, vous pouvez en effet diriger le faisceau de lumière LED vers un point d'intérêt particulier, tandis que montée sur les différents clusters disponibles, elle peut créer plusieurs schémas d'éclairage, du fonctionnel au décoratif, variables à souhait. Maintenant disponible dans la nouvelle finition Terra et en version plafonnrière. Dans Spider, la simplicité de la forme met en valeur la polyvalence des performances. ●FR

Spider ist eine kugelförmige Hängeleuchte, die an ein Auge erinnert, das jeden Punkt im Raum erblicken kann. Durch Einstellen des Winkels des Diffusors kann der LED-Lichtstrahl tatsächlich auf eine spezielle Stelle gerichtet werden, während durch die Kombination zu unterschiedlichen verfügbaren Clustern verschiedene Lichtschemata erstellt werden können - von funktionell bis dekorativ und nach Belieben dimmbar. Jetzt in der neuen Ausführung Terra und in der Deckenversion erhältlich. Bei Spider betont die Einfachheit der Form die vielseitigen Leistungen. ●DE

Spider es una lámpara colgante esférica que recuerda un ojo que puede mirar a cualquier punto de la habitación. Regulando el ángulo del difusor, de hecho, se puede dirigir el haz de luz de LED en un punto particular de interés, mientras que instalada en los diferentes sistemas cluster disponibles puede crear múltiples esquemas de luz, desde el funcional al decorativo, regulable a gusto. Ahora disponible en el nuevo acabado Terra y en la versión de techo. En Spider, la simplicidad de la forma exalta la versatilidad de las prestaciones. ●ES

Spider – это сферический подвесной светильник, напоминающий глаз, который может смотреть в любую точку помещения. Регулируя угол диффузора, можно направлять пучок светодиодного света на конкретную точку, а при установке в различных кластерах – создавать разнообразные схемы освещения, от функционального до декоративного, с возможностью регулировки яркости. Сейчас лампа выпускается с новой отделкой Terra и в форме потолочного плафона. Простота формы Spider подчеркивает его универсальность. ●RU

Spider是一款球形吊灯，像一只眼睛，可以望向房间里的每一个角落。调节灯罩的角度，可以把LED灯的光束调向特定角度，如安装在不同的组合吊上，可营造多重光幕，可满足从功能性到装饰性的需求，并根据喜好调光。吸顶灯版本的大地色饰面如今也可提供。Spider的简单造型彰显了其性能的广泛用途。●ZH

Visit website:



Spider » Cluster suspension lamp

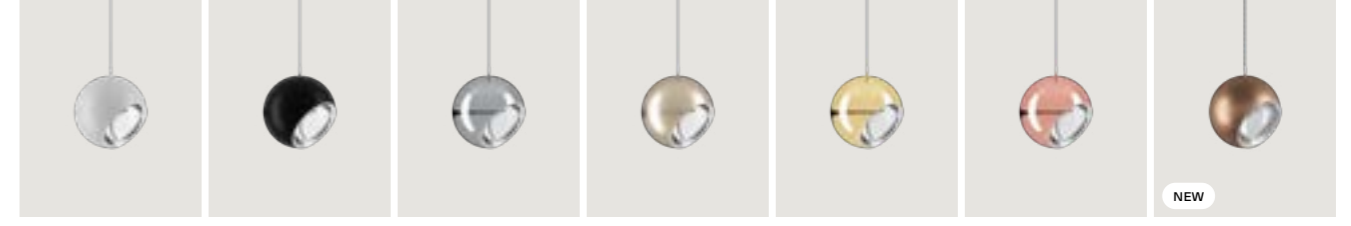

Spider » Ceiling lamp **NEW LAMP**

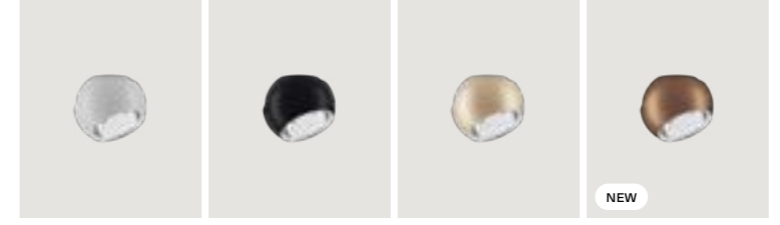

Spider, design by Studio Italia Design, 2015

Cluster suspension lamp

Spider

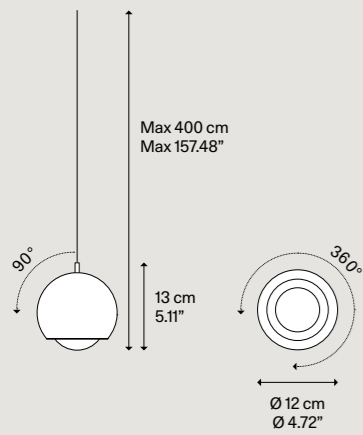

Light source Sorgente luminosa	Metal structure Montatura in metallo	Metal diffuser Diffusore in metallo	Code Codice
LED ↘ 2700 K ↘ 10 W/920 lm ↘ 220-240 V ↘ CRI 90 ↘ MacAdam 3-Step	Chrome Cromo	Matte White - 9010 Bianco Opaco - 9010	16020 1021
		Matte Black - 9005 Nero Opaco - 9005	16020 2021
LED included LED incluso	or	Chrome Cromo	16020 4021
		Matte Champagne Champagne Opaco	16020 4521
LED included LED incluso	or	Gold Oro	16020 5021
		Rose Gold Oro Rosa	16020 5521
LED included LED incluso	or	Terra NEW Terra	16020 6721
		Matte White - 9010 Bianco Opaco - 9010	16020 1031
LED included LED incluso	or	Matte Black - 9005 Nero Opaco - 9005	16020 2031
		Chrome Cromo	16020 4031
LED included LED incluso	or	Matte Champagne Champagne Opaco	16020 4531
		Gold Oro	16020 5031
LED included LED incluso	or	Rose Gold Oro Rosa	16020 5531
		Terra NEW Terra	16020 6731

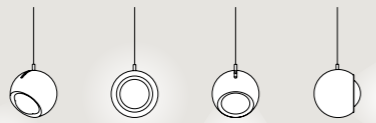

Adjustable light
Luce orientabile

Net weight/Peso netto: 0.8 kg Pack/Colli: 2

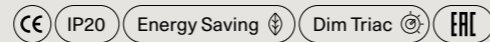

Suspension lamps must be installed on a canopy ▶ pag. 396-405
Le lampade a sospensione devono essere installate su rosone ▶ pag. 396-405

Example of composition 12 Lights Radial

R06L12 1000 8 x 999A4 00 4 x 16020 5021 4 x 16020 5521

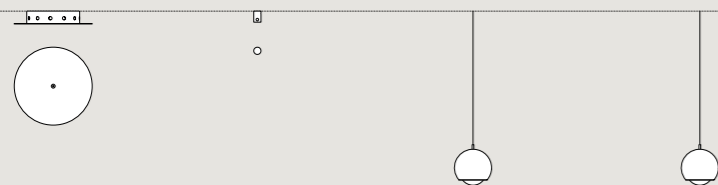

LED sources with direct power supply to the AC line voltage - driver not required. Dimmable with phase cut dimmer.

Spider, design by Studio Italia Design, 2022

Ceiling lamp

Spider NEW

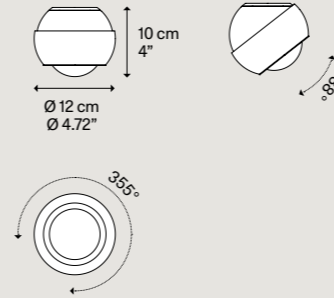

Light source Sorgente luminosa	Metal structure Montatura in metallo	Metal diffuser Diffusore in metallo	Code Codice
LED ↘ 2700 K ↘ 10 W/920 lm ↘ 220-240 V ↘ CRI 90 ↘ MacAdam 3-Step	Chrome Cromo	Matte White - 9010 Bianco Opaco - 9010	18340 1027
		Matte Black - 9005 Nero Opaco - 9005	18340 2027
LED included LED incluso	or	Extra Matte Champagne Champagne Extra Opaco	18340 4527
		Terra NEW Terra	18340 6727
LED included LED incluso	or	Matte White - 9010 Bianco Opaco - 9010	18340 1030
		Matte Black - 9005 Nero Opaco - 9005	18340 2030
LED included LED incluso	or	Extra Matte Champagne Champagne Extra Opaco	18340 4530
		Terra NEW Terra	18340 6730



Adjustable light
Luce orientabile

Net weight/Peso netto: 0.80 kg Pack/Colli: 2

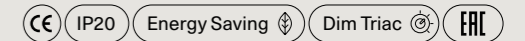

LED sources with direct power supply to the AC line voltage - driver not required. Dimmable with phase cut dimmer.

LED con alimentazione diretta a tensione di rete - non necessita di driver. Dimmerabile con varialuce a taglio di fase.

Kelly Cluster

Kelly Cluster spectacularly reinterprets the creative intuition of the family of Kelly lights in a sculptural and extremely compact sphere, mounted on a canopy and allowing multiple different compositions at will. A suspension lamp in metal, characterised by its lightness and vibrancy thanks to the unique laser cuts that create captivating plays of light and shadow, it is available in four different finishes bringing any space to life.

Kelly Cluster riformula brillantemente l'intuizione creativa della famiglia di lampade Kelly in una sfera sculturale ed estremamente compatta che, montata su rosone, permette di realizzare composizioni multiple a piacere. Lampada a sospensione in metallo, leggera e vivace grazie ai particolari tagli a laser che creano affascinanti giochi di luci e ombre, è disponibile in quattro diverse finiture in grado di far risaltare qualsiasi ambiente.

Cluster suspension lamp

Kelly Cluster, FINISHES Coppery Bronze,
Matte Black and Matte Champagne

Kelly Cluster, *design by* Andrea Toso, 2015





Kelly Cluster, composition of 14 lights
on a *round canopy*, FINISHES Matte Black
and Matte Champagne



Kelly Cluster, composition of 10 lights on a *radial canopy*, FINISH Matte White



Kelly Cluster, Special composition,
FINISH Coppery Bronze

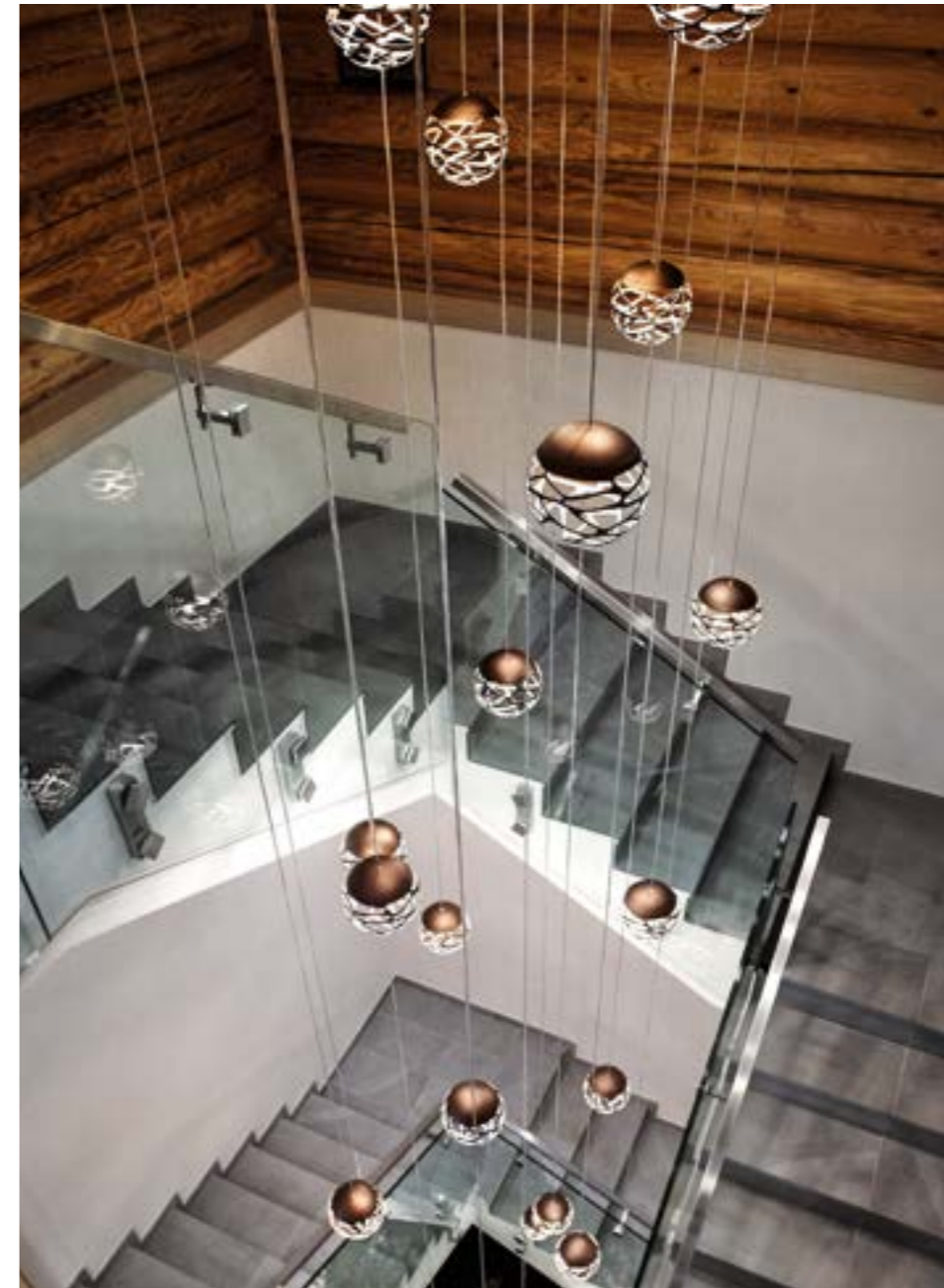

Kelly Cluster reformule brillamment l'intuition créative de la famille de lampes Kelly dans une sphère sculpturale et extrêmement compacte qui, montée sur une patère, permet de réaliser d'innombrables compositions. Lampe à suspension en métal, légère et animée grâce aux originales découpes laser qui créent de fascinants jeux de lumière et d'ombres ; plusieurs finitions disponibles pour valoriser tous les espaces. ● FR

Kelly Cluster formuliert die kreative Intuition der Leuchtenfamilie Kelly auf brillante Weise in einer skulpturellen und besonders kompakten Kugel wieder, die auf einem Baldachin montiert die Umsetzung verschiedener Kombinationen nach Wahl ermöglicht. Hängeleuchte aus Metall, die dank besonderer Laserschnitte leicht und lebhaft ist. Sie sorgen außerdem für faszinierende Spiele aus Licht und Schatten. Die Leuchte ist in vier verschiedenen Ausführungen erhältlich, um jeden Raum aufzuwerten. ● DE

Kelly Cluster reformula brillantemente la intuición creativa de la familia de lámparas Kelly en una esfera escultural y extremadamente compacta que, montada en un florón, permite crear múltiples composiciones a voluntad. Lámpara colgante de metal, ligera y alegre gracias a los cortes especiales de láser que crean fascinantes juegos de luz y sombra, está disponible en cuatro acabados diferentes capaces de resaltar cualquier ambiente. ● ES

Kelly Cluster блестяще обыгрывает в новом ключе творческую интуицию, воплощенную в семействе светильников Kelly, выполненных в скульптурной и необыкновенно компактной форме шара, монтируя который на потолочное крепление можно создавать множественные композиции на свой вкус. Металлический подвесной светильник с изящным и динамичным дизайном благодаря особым прорезям, выполненным методом лазерной резки и создающим чарующую игру света и тени, доступен в четырёх разных вариантах отделки, которые украсят любой интерьер. ● RU

Kelly Cluster在一个雕塑般紧凑的球体中巧妙地重新构造了Kelly灯家族系列的创意直觉, 该球体安装在底盘上, 可让您根据需要创建多种组合。金属制成的吊灯, 光线明亮、活泼, 这要归功于其特殊的激光切割工艺, 可以产生引人入胜的光影效果, 并提供四种不同的颜色, 可以烘托任何环境。● ZH

Visit website:



Kelly Cluster, design by Andrea Tosetto, 2015

Cluster suspension lamp

Kelly Cluster

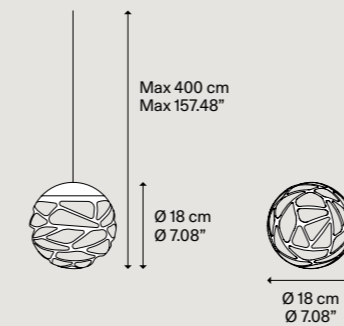

Light source
Sorgente luminosa

LED
 ↳ 2700 K
 ↳ 8 W/920 lm
 ↳ 220-240 V
 ↳ CRI 92
 ↳ MacAdam 3-Step

LED included
LED incluso

Metal structure
Montatura in metallo

- Matte White – 9010
Bianco Opaco – 9010
- Matte Black – 9005
Nero Opaco – 9005
- Coppery Bronze
Bronzo Ramato
- Matte Champagne
Champagne Opaco

Glass diffuser
Diffusore in vetro

- Glossy White
Bianco Lucido

Code
Codice

- 14710 1027
- 14710 2027
- 14710 3527
- 14710 4527

Net weight/Peso netto: 1 kg

Pack/Colli: 1

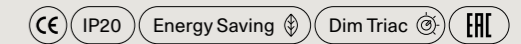

Suspension lamps must be installed on a canopy ▶ pag. 396-405
Le lampade a sospensione devono essere installate su rosone ▶ pag. 396-405

Example of composition

3 Lights Round

R04L03 1000 1 × 14710 2027 1 × 14710 3527 1 × 14710 4527

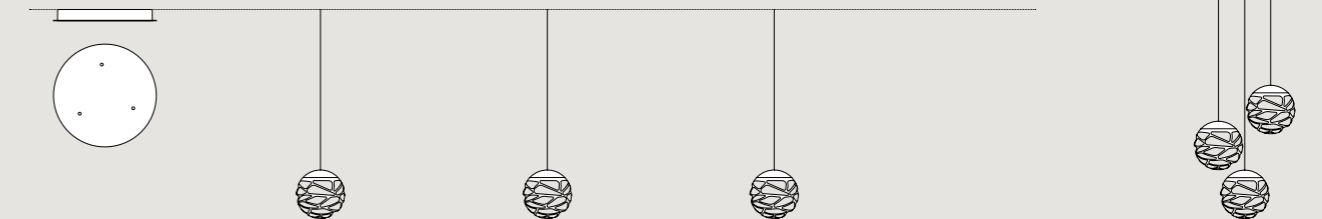

Example of composition

Short Lights Track

R08L98 1000 5 × 14710 4527

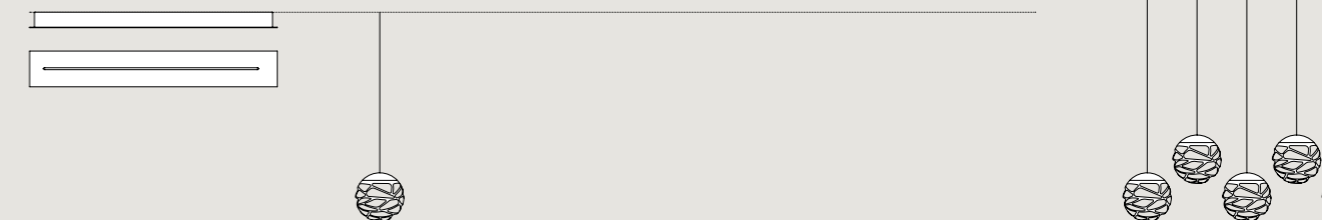

Kelly Cluster ↳ Cluster suspension lamp

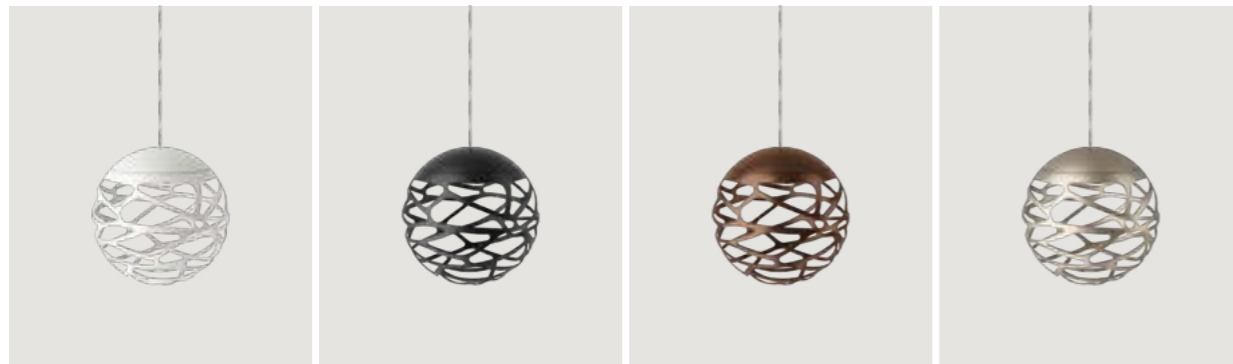

Kelly

Seductive beauty with a bold personality thanks to the strong and precise laser cuts, which lighten the metal of the lampshade and create an intriguing play of light and shadow. Kelly is a multifaceted family of suspension and wall lamps that stand out with elegance in any living space thanks to the variety of available forms and finishes.

Una bellezza seducente dalla personalità audace grazie a tagli laser forti e precisi che alleggeriscono il metallo del paralume e creano un intrigante gioco di luci e ombre. Kelly è una famiglia poliedrica di lampade a sospensione e a parete che si distingue con eleganza in ogni ambiente abitativo grazie alla varietà di forme e finiture disponibili.

Suspension lamp, Wall lamp

Kelly small dome 50, Kelly medium dome 60 and Kelly large dome 80,
FINISH Matte White

Kelly, *design by* Andrea Tosetto, 2015

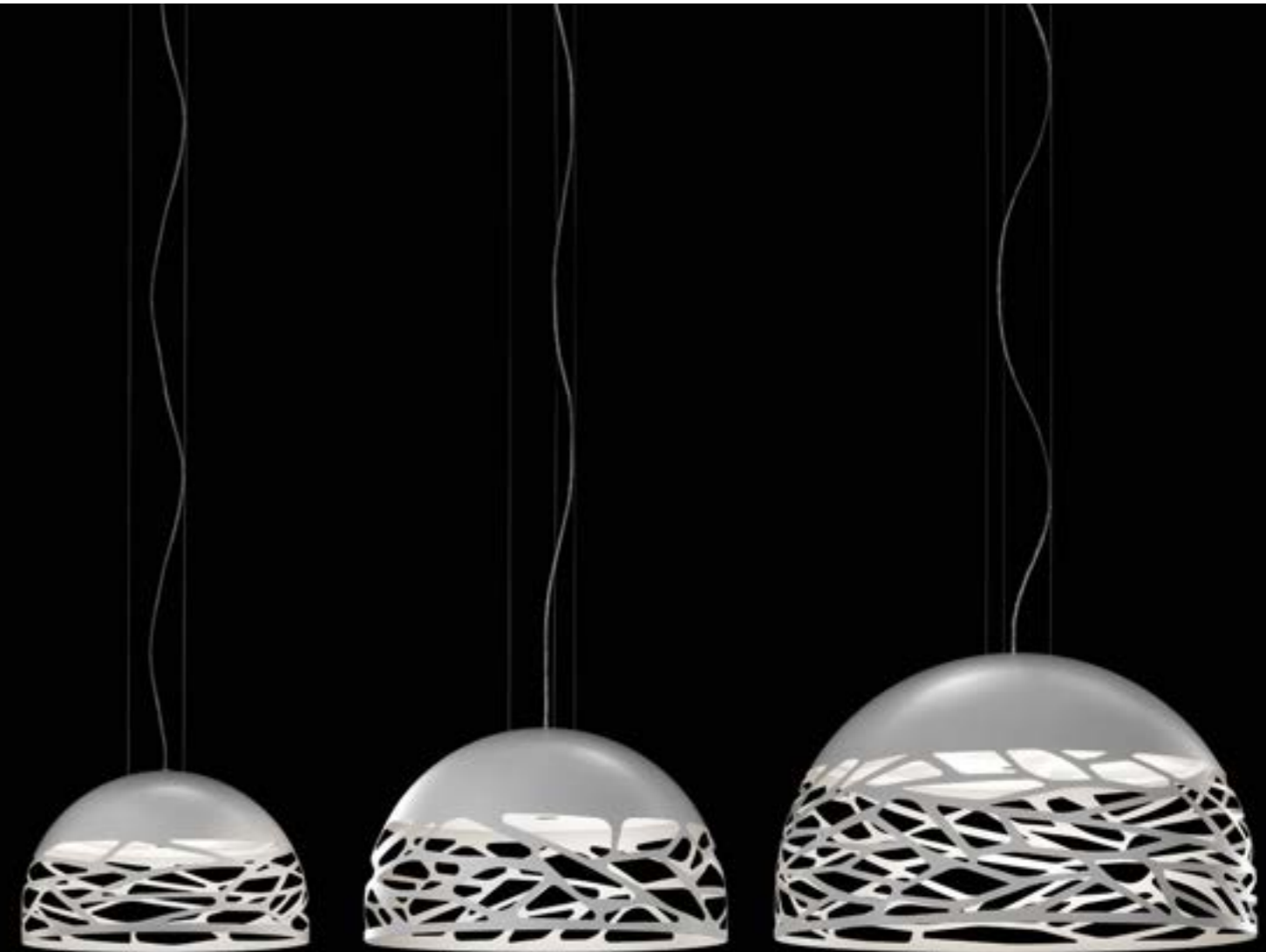



Kelly small dome 50, FINISH Matte Black

Kelly small dome 50,
FINISH Matte Black



Kelly medium dome 60, FINISH Matte White



Kelly, FINISH Matte White

Kelly large dome 80,
FINISH Matte Champagne



Kelly small dome 50,
FINISH Coppery Bronze



Kelly small dome 50, FINISH Coppery Bronze

Kelly small sphere 40, Kelly medium sphere 50 and Kelly large sphere 80, FINISH Matte White



Kelly small sphere 40, Kelly medium sphere 50 and Kelly large sphere 80, FINISH Coppery Bronze

Une beauté séduisante d'une personnalité audacieuse grâce aux découpes laser puissantes et précises qui allègent le métal de l'abat-jour et créent un intrigant jeu de lumière et d'ombres. Kelly est une famille polyédrique de lampes à suspension et d'appliques qui se distingue avec élégance dans toutes les pièces de vie grâce à la variété de formes et de finitions disponibles. ● FR

Verführerische Schönheit mit gewagter Persönlichkeit, die durch starke und genaue Laserschnitte zum Ausdruck gebracht wird, die das Metall des Lampenschirms leicht erscheinen lassen und ein betrügerisches Spiel aus Licht und Schatten schaffen. Kelly ist eine vielseitige Familie aus Hänge- und Wandleuchten, die sich durch Eleganz in jedem Wohnraum auszeichnet, die den verschiedenen verfügbaren Formen und Ausführungen zu verdanken ist. ● DE

Una belleza seductora con una personalidad atrevida gracias a fuertes y precisos cortes de láser que iluminan el metal de la pantalla de la lámpara y crean un intrigante juego de luces y sombras. Kelly es una versátil familia de lámparas colgantes y de pared que destaca con elegancia en todos los entornos gracias a la variedad de formas y acabados disponibles. ● ES

Соблазнительная красота с решительным характером создана благодаря четким и выразительным прорезям, выполненным методом лазерной резки, которые облегчают металлический абажур и создают интригующую игру света и тени. Kelly – это семейство универсальных подвесных и настенных светильников, которые элегантно украшают любой жилой интерьер благодаря разнообразию доступных форм и отделки. ● RU

强劲而精确的激光切割使灯罩的金属发亮，并创造出有趣的光影效果，具有诱人的美感和大胆的个人性。Kelly是一个悬吊式和壁灯系列的产品，其多种多样的外形和颜色使其在任何生活环境中均格外高雅。● ZH

Visit website:



Kelly small dome 50 ↘ Suspension lamp

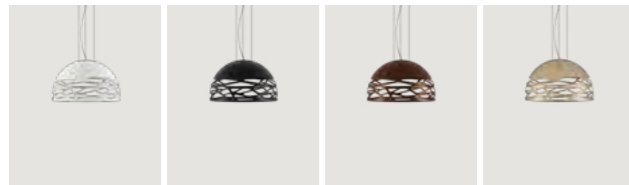

Kelly medium dome 60 ↘ Suspension lamp

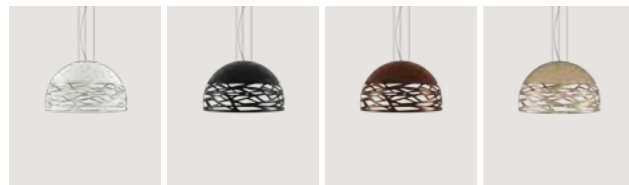

Kelly large dome 80 ↘ Suspension lamp



Kelly ↘ Wall lamp

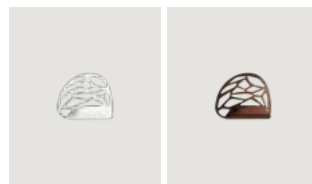

Kelly small sphere 40 ↘ Suspension lamp

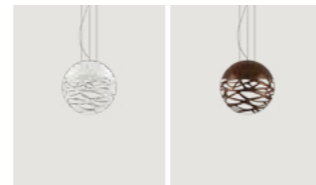

Kelly medium sphere 50 ↘ Suspension lamp

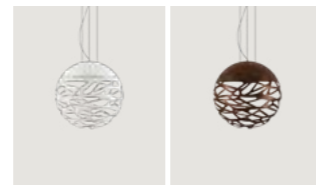

Kelly large sphere 80 ↘ Suspension lamp

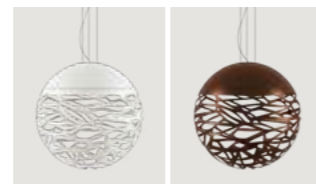

Kelly, design by Andrea Tosetto, 2015

Suspension lamp

Kelly small dome 50

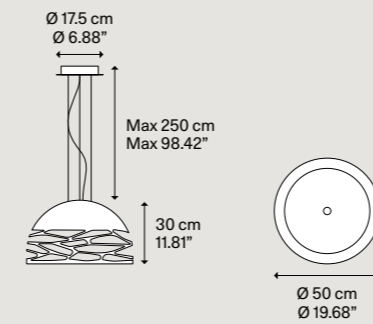

Net weight / Peso netto: 6 kg

Pack / Colli: 1

Light source

Sorgente luminosa
E27 Classic A60
↘ 3 × max 46 W Eco



E27 LED
↘ 3 × 25 W
W/L max 12 cm
W/L max 4.72"

Bulbs not included
Lampadine non incluse

Metal structure

- Montatura in metallo
- Matte White – 9010
Bianco Opaco – 9010
 - Matte Black – 9005
Nero Opaco – 9005
 - Coppery Bronze
Bronzo Ramato
 - Matte Champagne
Champagne Opaco

Glass diffuser

- Diffusore in vetro
- Glossy White
Bianco Lucido

Code
Codice

- 14126 1000
- 14126 2000
- 14126 3500
- 14126 4500

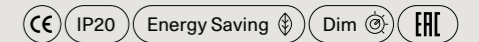

Kelly medium dome 60

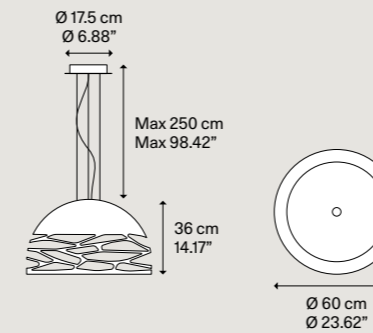

Net weight / Peso netto: 7.15 kg

Pack / Colli: 1

E27 Classic A60
↘ 3 × max 46 W Eco

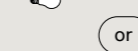

E27 LED
↘ 3 × 25 W
W/L max 12 cm
W/L max 4.72"

Bulbs not included
Lampadine non incluse

- Montatura in metallo
- Matte White – 9010
Bianco Opaco – 9010
 - Matte Black – 9005
Nero Opaco – 9005
 - Coppery Bronze
Bronzo Ramato
 - Matte Champagne
Champagne Opaco

- Diffusore in vetro
- Glossy White
Bianco Lucido

- 14127 1000
- 14127 2000
- 14127 3500
- 14127 4500

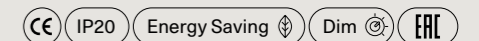

Kelly large dome 80

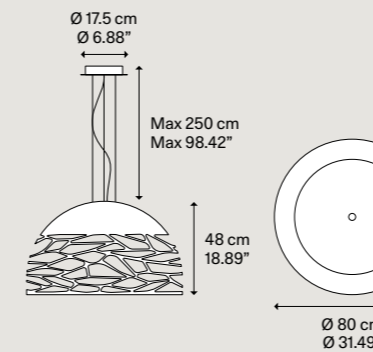

Net weight / Peso netto: 11 kg

Pack / Colli: 1

E27 Classic A60
↘ 4 × max 46 W Eco



E27 LED
↘ 4 × 25 W
W/L max 12 cm
W/L max 4.72"

Bulbs not included
Lampadine non incluse

- Montatura in metallo
- Matte White – 9010
Bianco Opaco – 9010
 - Matte Black – 9005
Nero Opaco – 9005
 - Coppery Bronze
Bronzo Ramato
 - Matte Champagne
Champagne Opaco

- Diffusore in vetro
- Glossy White
Bianco Lucido

- 14128 1000
- 14128 2000
- 14128 3500
- 14128 4500

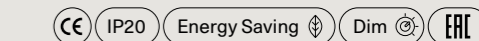

Kelly, design by Andrea Tosetto, 2015

Suspension lamp

Kelly small sphere 40

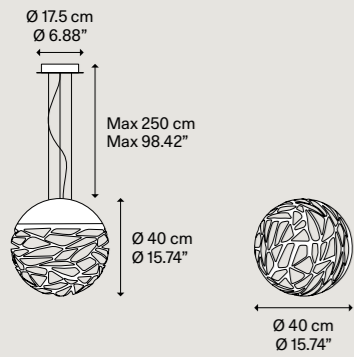

Light source Sorgente luminosa	Metal structure Montatura in metallo	Glass diffuser Diffusore in vetro	Code Codice
E27 Classic A60 ↘ 3 × max 46 W Eco	<input type="radio"/> Matte White – 9010 Bianco Opaco – 9010 <input type="radio"/> or <input type="radio"/> Coppery Bronze Bronzo Ramato	<input type="radio"/> Glossy White Bianco Lucido	14122 1000
E27 LED ↘ 3 × 25 W W/L max 12 cm W/L max 4.72"			14122 3500
Bulbs not included Lampadine non incluse			

Net weight/Peso netto: 5.5 kg Pack/Colli: 2

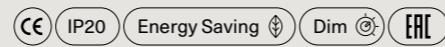

Kelly medium sphere 50

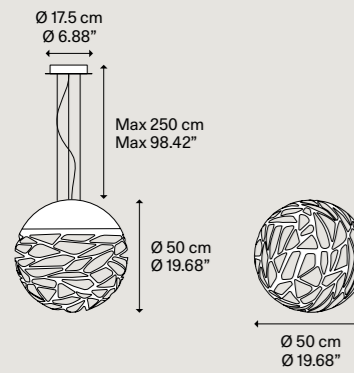

Light source Sorgente luminosa	Metal structure Montatura in metallo	Glass diffuser Diffusore in vetro	Code Codice
E27 Classic A60 ↘ 3 × max 46 W Eco	<input type="radio"/> Matte White – 9010 Bianco Opaco – 9010 <input type="radio"/> or <input type="radio"/> Coppery Bronze Bronzo Ramato	<input type="radio"/> Glossy White Bianco Lucido	14123 1000
E27 LED ↘ 3 × 25 W W/L max 12 cm W/L max 4.72"			14123 3500
Bulbs not included Lampadine non incluse			

Net weight/Peso netto: 9 kg Pack/Colli: 2

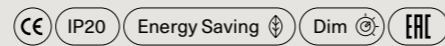

Kelly large sphere 80

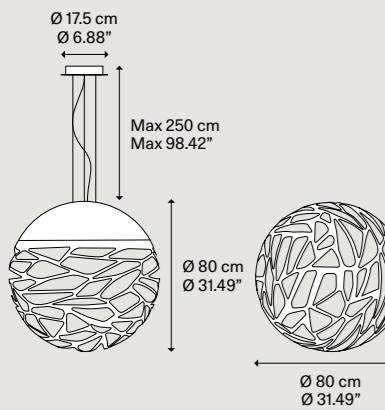

Light source Sorgente luminosa	Metal structure Montatura in metallo	Glass diffuser Diffusore in vetro	Code Codice
E27 Classic A60 ↘ 4 × max 46 W Eco	<input type="radio"/> Matte White – 9010 Bianco Opaco – 9010 <input type="radio"/> or <input type="radio"/> Coppery Bronze Bronzo Ramato	<input type="radio"/> Glossy White Bianco Lucido	14124 1000
E27 LED ↘ 4 × 25 W W/L max 12 cm W/L max 4.72"			14124 3500
Bulbs not included Lampadine non incluse			

Net weight/Peso netto: 15 kg Pack/Colli: 2

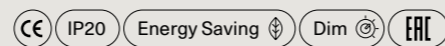

Kelly, design by Andrea Tosetto, 2015

Wall lamp

Kelly

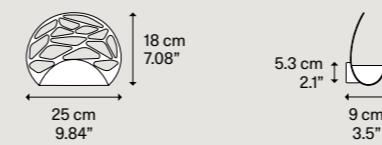

Light source Sorgente luminosa	Metal structure Montatura in metallo	Code Codice
LED ↘ 2700 K ↘ 15 W/1750 lm ↘ 220-220 V ↘ CRI 92 ↘ MacAdam 3-Step	<input type="radio"/> Matte White – 9010 Bianco Opaco – 9010 <input type="radio"/> Coppery Bronze Bronzo Ramato	14150 1027
LED included LED incluso		14150 3527

Net weight/Peso netto: 0.8 kg Pack/Colli: 1

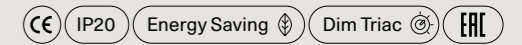

LED sources with direct power supply to the AC line voltage – driver not required. Dimmable with phase cut dimmer.

LED con alimentazione diretta a tensione di rete – non necessita di driver. Dimmerabile con varialuce a taglio di fase.

JIM

Immediate function, uncomplicated style, durable materials, modular at will. Inspired by the abat-jours of the ateliers of the early 1900s, JIM is a system of suspension lamps with distinctive shapes and a versatile composition that suits any interiors and living environment. JIM's versatility is further enhanced by the colour range: the four different finishes for the shades can be combined with the three different suspension hook hues as desired.

Immediatezza di funzione, semplicità delle linee, materiali durevoli, componibilità a piacere. Ispirato ai paralumi degli atelier di artisti dell'inizio del 1900, JIM è un sistema di lampade a sospensione dalle forme distintive e dalla composizione versatile che si adatta a qualsiasi interno e ambiente abitativo. La versatilità di JIM è ulteriormente valorizzata dalla gamma cromatica: le quattro diverse finiture disponibili per i paralumi possono essere combinate a piacere con le tre diverse tonalità del gancio a cui è sospesa la lampada.

Cluster suspension lamp, Suspension lamp

JIM dome,
FINISH Matte White

JIM, *design by* Patrick Norguet, 2021





JIM dome,
FINISH Matte Champagne



JIM dome, FINISH Coppery Bronze



JIM dome, FINISH Matte Balck



JIM cylinder, cone and bell,
single mini canopies, FINISH Matte White



JIM bell, FINISH Matte Champagne

JIM cylinder, cone and bell, composition of 36 lights on a *round canopy*, FINISHES Matte Black and Matte Champagne





JIM cylinder, cone and bell, composition of 14 lights on a *rectangular canopy*, FINISH Matte Black

1



2



1–JIM bell, cylinder and cone,
FINISHES Matte White,
Matte Champagne and Matte Black

2–JIM cylinder, cone and bell,
FINISH Coppery Bronze

Immédiateté de fonction, simplicité des lignes, matériaux durables, modularité en fonction des goûts personnels. S'inspirant des abat-jours des ateliers d'artistes du début du XXe siècle, JIM est un système de lampes à suspension arborant des formes distinctives et une composition polyvalente qui s'adapte à tous les styles d'habitation. La gamme chromatique souligne encore plus la polyvalence de JIM : les quatre différentes finitions disponibles pour les diffuseurs peuvent s'assortir, au choix, aux trois différentes tonalités du crochet de soutien. ● FR

Unmittelbarkeit der Funktion, Einfachheit der Linien, haltbare Materialien, Modularität nach Belieben. Inspiriert an den Lampenschirmen der Künstlerateliers der frühen 1900er Jahre, ist JIM ein Hängeleuchtsystem mit unverwechselbaren Formen und vielseitiger Gestaltungsmöglichkeit, das sich an jedes Interieur und jede Wohnumgebung anpasst. Die Vielseitigkeit von JIM wird durch die Farbpalette noch verstärkt: Die vier verschiedenen erhältlichen Ausführungen der Lampenschirme können beliebig mit den drei verschiedenen Farbtönen des Hakens, an dem die Leuchte aufgehängt wird, kombiniert werden. ● DE

Inmediatez de función, líneas sencillas, materiales duraderos y modularidad sin límites. Inspirado en las pantallas de los ateliers de artistas de principios del siglo XX, JIM es un sistema de lámparas colgantes con formas características y composición versátil que se adapta a cualquier interior y ambiente. La versatilidad de JIM la valoriza aún más la gama cromática: los cuatro acabados distintos disponibles para las pantallas se pueden combinar sin límites con los tres tonos del gancho en el que se cuelga la lámpara. ● ES

Улучшенная функциональность, простота линий, прочные материалы, модульная композиция. JIM представляет собой систему подвесных светильников, созданную в стиле абажуров ателье художников начала 1900-х годов, отличающуюся характерными формами и универсальной композицией, легко адаптирующуюся к любому интерьеру и жилищу. Универсальность применения системы JIM дополнительно повышена за счет хроматического диапазона: четыре варианта отделки абажуров комбинируются по желанию с тремя разными тональностями крюка, на котором подвешена лампа. ● RU

组拼随意的模块化与功能及时、线条简约和材料坚实之特性相邂逅。灵感源于二十世纪初期艺术家工坊中的灯罩，JIM是一种形状独特且组合多样的悬吊灯系统，适用于任何室内装饰与家居环境。色调范围之广，使JIM的通用性越发增值：灯罩的四种不同饰面可按喜好与悬灯钩的三种不同色调相搭配。● ZH

Visit website:



JIM dome ↘ Suspension lamp

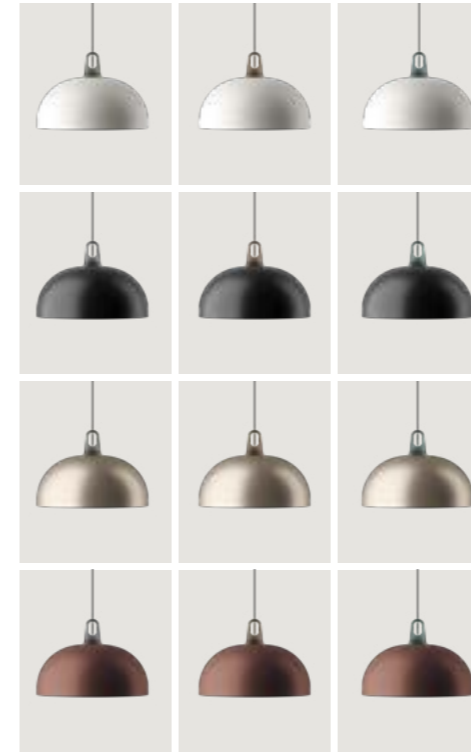

JIM bell ↘ Cluster suspension lamp

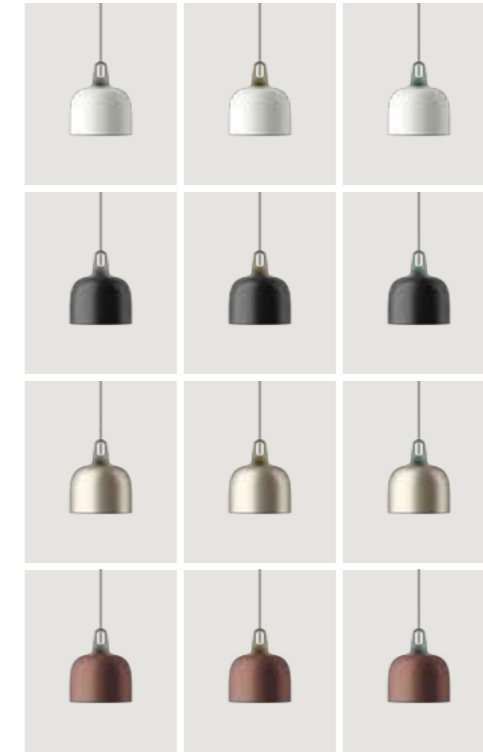

JIM cone ↘ Cluster suspension lamp

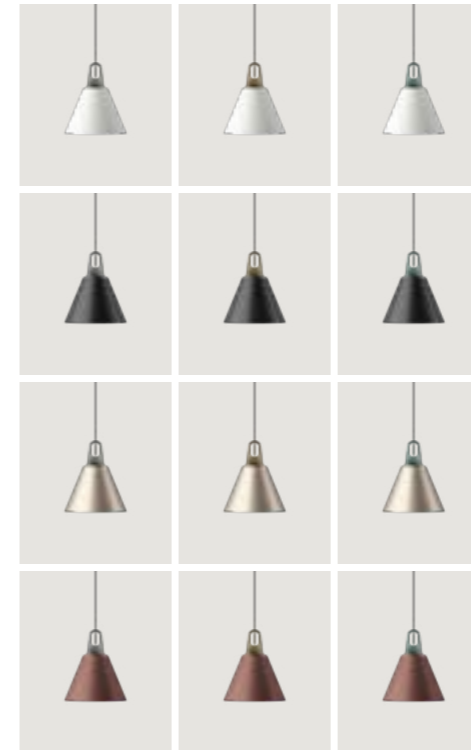

JIM cylinder ↘ Cluster suspension lamp

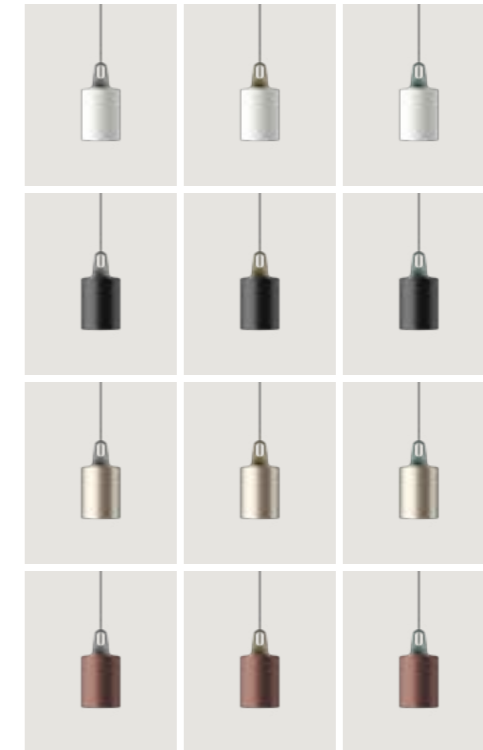

Grey hook
Gancio Grigio

Honey hook
Gancio Miele

Turquoise hook
Gancio Turchese

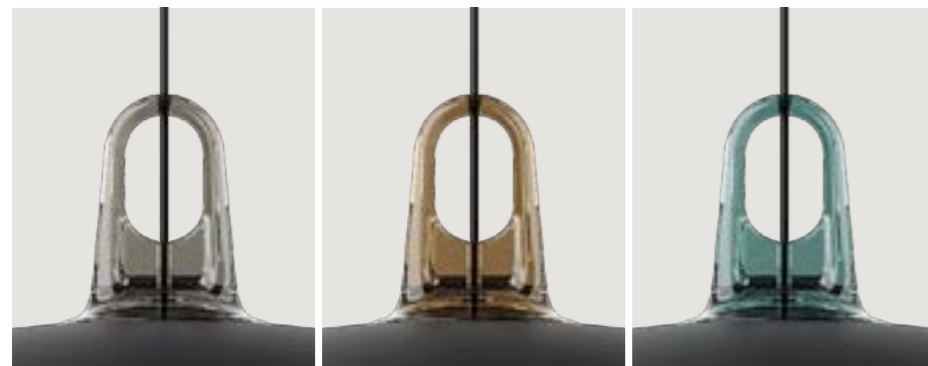

JIM, design by Patrick Norguet, 2021

Suspension lamp

JIM dome

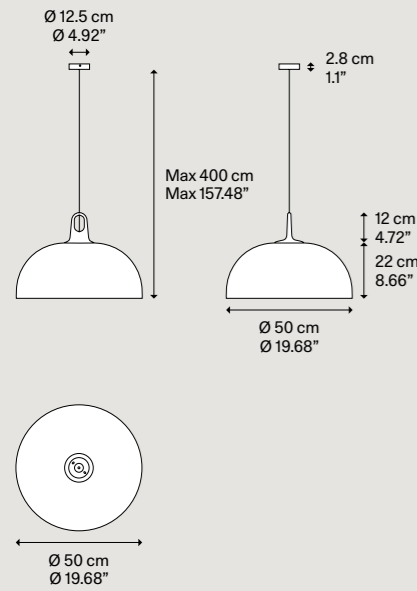

E27 A60 LED
1 x 25 W

Bulb not included
Lampadina non inclusa

Light source Sorgente luminosa	Outside metal diffuser Diff. esterno in metallo	Inside metal diffuser Diff. interno in metallo	Hook methacrylate Gancio in metacrilato	Code Codice
	Matte White-9010 Bianco Opaco-9010	Matte White-9010 Bianco Opaco-9010	Grey Grigio	16924 2300
			Honey Miele	16924 6300
			Turquoise Turchese	16924 8200
			Grey Grigio	16924 2800
	Matte Black-9005 Nero Opaco-9005	Matte White-9010 Bianco Opaco-9010	Honey Miele	16924 6600
			Turquoise Turchese	16924 8500
			Grey Grigio	16924 2700
	Matte Champagne Champagne Opaco	Matte White-9010 Bianco Opaco-9010	Honey Miele	16924 6500
			Turquoise Turchese	16924 8400
			Grey Grigio	16924 2400
	Coppery Bronze Bronzo Ramato	Matte White-9010 Bianco Opaco-9010	Honey Miele	16924 6400
			Turquoise Turchese	16924 8300

Net weight/Peso netto: 2.2 kg

Pack/Colli: 2

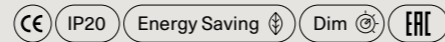

JIM, design by Patrick Norguet, 2021

Cluster suspension lamp

JIM bell

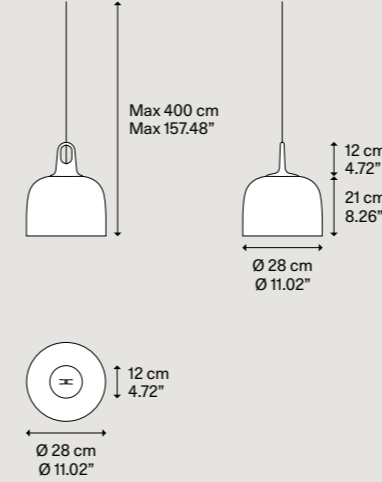

E27 A60 LED
1 x 25 W

Bulb not included
Lampadina non inclusa

Light source Sorgente luminosa	Outside metal diffuser Diff. esterno in metallo	Inside metal diffuser Diff. interno in metallo	Hook methacrylate Gancio in metacrilato	Code Codice
	Matte White-9010 Bianco Opaco-9010	Matte White-9010 Bianco Opaco-9010	Grey Grigio	16921 2300
			Honey Miele	16921 6300
			Turquoise Turchese	16921 8200
			Grey Grigio	16921 2800
	Matte Black-9005 Nero Opaco-9005	Matte White-9010 Bianco Opaco-9010	Honey Miele	16921 6600
			Turquoise Turchese	16921 8500
			Grey Grigio	16921 2700
	Matte Champagne Champagne Opaco	Matte White-9010 Bianco Opaco-9010	Honey Miele	16921 6500
			Turquoise Turchese	16921 8400
			Grey Grigio	16921 2400
	Coppery Bronze Bronzo Ramato	Matte White-9010 Bianco Opaco-9010	Honey Miele	16921 6400
			Turquoise Turchese	16921 8300

Net weight/Peso netto: 1.9 kg

Pack/Colli: 2

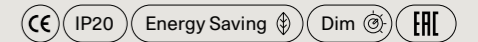

Suspension lamps must be installed on a canopy ► pag. 396-405
Le lampade a sospensione devono essere installate su rosone ► pag. 396-405

JIM, design by Patrick Norguet, 2021

Cluster suspension lamp

JIM cone

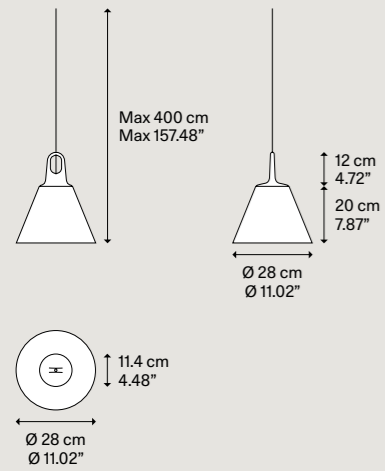

Light source Sorgente luminosa	Outside metal diffuser Diff. esterno in metallo	Inside metal diffuser Diff. interno in metallo	Hook methacrylate Gancio in metacrilato	Code Codice		
E27 A60 LED 1 x 25 W	Matte White-9010 Bianco Opaco-9010	Matte White-9010 Bianco Opaco-9010	Grey Grigio	16922 2300		
			Honey Miele	16922 6300		
			Turquoise Turchese	16922 8200		
			Grey Grigio	16922 2800		
			Honey Miele	16922 6600		
			Turquoise Turchese	16922 8500		
			Grey Grigio	16922 2700		
			Matte Champagne Champagne Opaco	Matte White-9010 Bianco Opaco-9010	Honey Miele	16922 6500
			Turquoise Turchese	16922 8400		
			Grey Grigio	16922 2400		
			Coppery Bronze Bronzo Ramato	Matte White-9010 Bianco Opaco-9010	Honey Miele	16922 6400
			Turquoise Turchese	16922 8300		

Bulb not included
Lampadina non inclusa

Net weight/Peso netto: 1 kg Pack/Colli: 2

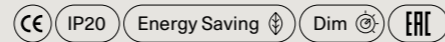

Suspension lamps must be installed on a canopy ▶ pag. 396-405
Le lampade a sospensione devono essere installate su rosone ▶ pag. 396-405

JIM, design by Patrick Norguet, 2021

Cluster suspension lamp

JIM cylinder

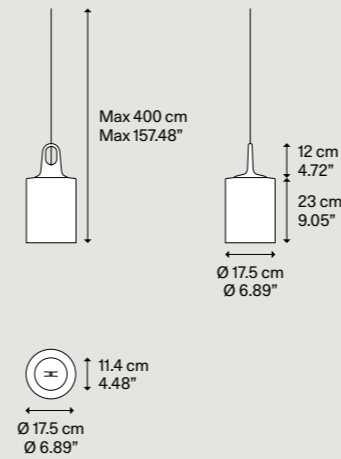

Light source Sorgente luminosa	Outside metal diffuser Diff. esterno in metallo	Inside metal diffuser Diff. interno in metallo	Hook methacrylate Gancio in metacrilato	Code Codice		
E27 A60 LED 1 x 25 W	Matte White-9010 Bianco Opaco-9010	Matte White-9010 Bianco Opaco-9010	Grey Grigio	16923 2300		
			Honey Miele	16923 6300		
			Turquoise Turchese	16923 8200		
			Grey Grigio	16923 2800		
			Honey Miele	16923 6600		
			Turquoise Turchese	16923 8500		
			Grey Grigio	16923 2700		
			Matte Champagne Champagne Opaco	Matte White-9010 Bianco Opaco-9010	Honey Miele	16923 6500
			Turquoise Turchese	16923 8400		
			Grey Grigio	16923 2400		
			Coppery Bronze Bronzo Ramato	Matte White-9010 Bianco Opaco-9010	Honey Miele	16923 6400
			Turquoise Turchese	16923 8300		

Bulb not included
Lampadina non inclusa

Net weight/Peso netto: 1.4 kg Pack/Colli: 2

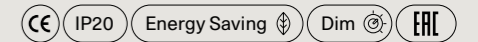

Suspension lamps must be installed on a canopy ▶ pag. 396-405
Le lampade a sospensione devono essere installate su rosone ▶ pag. 396-405

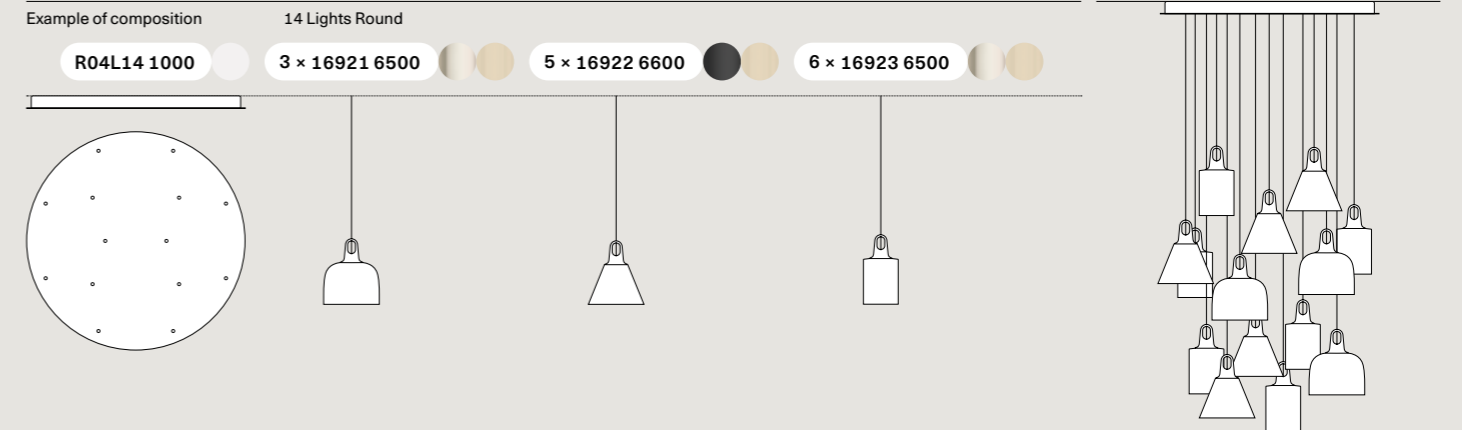

Volum

Volum is an exclusive series of glass lamps that is poetically simple yet complex in its technically driven solution. The four blown glass globes, with a glossy white finish, have different sizes measuring 14, 22, 29 and 42 cm (diameter). Thanks to their inherently distinct shapes, they complement each other intuitively to make unique compositions. Seamless and understated, each *Volum* globe is closed by a methacrylate lid that lets light through the same way as the glass. Designed to fill a space with an uninterrupted, 360-degree illumination, *Volum* glows uniformly in all directions providing a calming and coherent radiance.

Volum è una serie esclusiva di lampade in vetro poeticamente semplici seppur complesse nella loro realizzazione tecnica. Le quattro sfere in vetro soffiato, caratterizzate da una finitura bianca lucida, hanno dimensioni diverse che misurano 14, 22, 29 e 42 cm (diametro). Grazie alle loro forme intrinsecamente distinte si completano intuitivamente per creare composizioni uniche. Valorizzata da un design fluido e discreto, ciascuna sfera *Volum* è chiusa da una calotta in metacrilato che lascia passare la luce in modo uniforme come il vetro. Concepita per illuminare lo spazio a 360° senza interruzioni, *Volum* irradia uniformemente fasci di luce in ogni direzione, creando un'atmosfera rilassante e coerente.

Cluster suspension lamp, Suspension lamp

Volum 29, 22 and 14,
FINISH Glossy White

Volum, design by Snøhetta, 2022





Volum 14, 22 and 29, special composition of 475 lights on *recessed micro canopies*, FINISH Glossy White



Volum 14, *recessed micro canopies*, FINISH Glossy White

Volum 14, 22 and 29, 2 × composition of 3 lights on a *round canopy* and single lights on *recessed micro canopies*, FINISHES Glossy White





Volum 29, 22, 14 and 42, FINISH Glossy White



Volum, the methacrylate lid lets light through the same way as the glass



Volum 14, 22, 29 and 42, special composition of 68 lights, FINISH Glossy White



Volum 42, FINISH Glossy White



Volum 42, FINISH Glossy White

Volum est une série exclusive de lampes en verre poétiquement simples et complexes à la fois dans leur solution technique. Les quatre globes en verre soufflé, avec une finition blanc brillant, ont des tailles différentes mesurant 14, 22, 29 et 42 cm de diamètre. Grâce à leurs formes intrinsèquement distinctes, ils se complètent intuitivement pour former des compositions uniques. Mise en valeur par un design fluide et discret, chaque sphère *Volum* est clôturée par un capuchon en méthacrylate qui laisse passer la lumière de manière aussi uniforme que le verre. Conçu pour remplir un espace avec un éclairage ininterrompu, *Volum* brille uniformément dans toutes les directions, offrant un rayonnement apaisant et cohérent. ● FR

Volum ist eine exklusive Serie von Glasleuchten, die in ihrer technischen Lösung poetisch einfach und doch komplex ist. Die vier mundgeblasenen Glaskugeln mit glänzend weißer Oberfläche haben unterschiedliche Größen von 14, 22, 29 und 42 cm (Durchmesser). Dank ihrer grundsätzlich unterschiedlichen Formen ergänzen sie sich intuitiv zu einzigartigen Kompositionen. Nahtlos und unaufdringlich wird jede *Volum*-Kugel durch eine Abdeckung aus Methacrylat verschlossen, der ebenso wie das Glas Licht durchlässt. Entworfen, um einen Raum mit einer ununterbrochenen 360-Grad-Beleuchtung zu füllen, leuchtet *Volum* gleichmäßig in alle Richtungen und bietet eine beruhigende und einheitliche Lichtverteilung. ● DE

Volum es una serie exclusiva de lámparas de vidrio que aúnan sencillez y complejidad de manera poética en su solución técnica. Los cuatro globos de vidrio soplado, con un llamativo acabado blanco brillante, tienen diferentes tamaños que miden 14, 22, 29 y 42 cm de diámetro. Gracias a sus formas intrínsecamente distintas, se complementan intuitivamente para crear composiciones únicas. Con un diseño fluido y discreto, cada esfera *Volum* está cerrada por una tapa de metacrilato que permite el paso de la luz de forma tan uniforme como el cristal. La colección *Volum*, diseñada para llenar un espacio con una iluminación continua de 360°, brilla uniformemente en todas las direcciones y brinda un brillo tranquilizador y homogéneo. ● ES

Volum – это эксклюзивная серия стеклянных ламп, обладающих поэтической простотой в сочетании со сложными техническими решениями. Четыре сферы из дутого стекла с яркой глянцевой белой отделкой размерами 14, 22, 29 и 42 см (в диаметре), интуитивно и гармонично дополняющие друг друга, несмотря на разные размеры и естественные различные формы. Бесшовная и сдержанная, каждая сфера *Volum* закрыта крышкой из метакрилата, единственным съемным элементом которой является кабель. Созданная для наполнения пространства непрерывным светом, расходящимся на 360 градусов, лампа *Volum* равномерно сияет во всех направлениях, создавая успокаивающее и гармоничное свечение. ● RU

Volum 是一个独特的玻璃灯系列,从其技术驱动解决方案的角度来看,可饱含诗意地被视为一个既简约又复杂的灯饰系列。四个吹制玻璃球体带有大胆的亮泽白色饰面,尺寸分别为14厘米、22厘米、29厘米和42厘米(直径),尽管它们大小不同且形状也自然而然地有所不同,但它们能够直观且和谐地相互补充。无缝且低调,每个*Volum*球体都由甲基丙烯酸酯盖封闭且线缆是唯一的可拆卸元件。其设计旨在用不间断的360度照明来填充空间,*Volum*在各个方向均匀发光且提供平和连贯的光芒。● ZH

Visit website:



Volum, design by Snøhetta, 2022

Suspension lamp

Volum 42 NEW

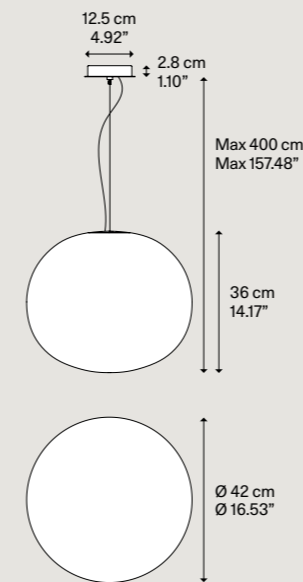

Net weight / Peso netto: 4 kg

Pack / Colli: 2

Light source Sorgente luminosa	Methacrylate structure Struttura in metacrilato	Blown glass diffuser Diffusore in vetro soffiato	Code Codice
E27 A60 LED ≈ 1 × 25 W	Glossy White Bianco Lucido	Glossy White Bianco Lucido	18720 1200
Ø max 9.8 cm – 3.74"			
Bulb not included Lampadina non inclusa			

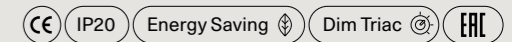

Volum 42 → Suspension lamp NEW LAMP



Volum 14, 22, 29 → Cluster suspension lamp NEW LAMP



Cluster suspension lamp

Volum 14 **NEW**

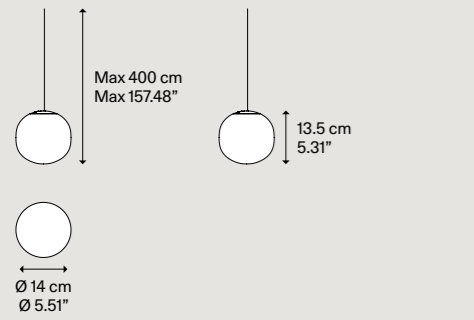

Light source Sorgente luminosa	Methacrylate structure Struttura in metacrilato	Blown glass diffuser Diffusore in vetro soffiato	Code Codice
ptl E14 ↘ 15 W	Glossy White Bianco Lucido	Glossy White Bianco Lucido	18711 1200
W/L max 8 cm W/L max 3.14"			
Bulb not included Lampadina non inclusa			

Net weight/Peso netto: 0.90 kg Pack/Colli: 2

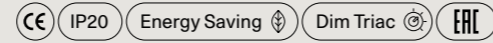

Volum 22 **NEW**

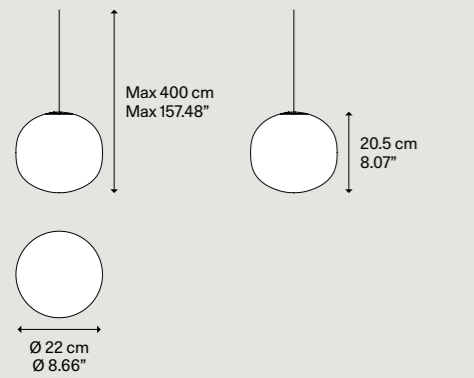

Light source Sorgente luminosa	Methacrylate structure Struttura in metacrilato	Blown glass diffuser Diffusore in vetro soffiato	Code Codice
E27 A60 LED ↘ 1 × 25 W	Glossy White Bianco Lucido	Glossy White Bianco Lucido	18712 1200
Ø max 6 cm - 2.36"			
W/L max 11 cm W/L max 4.33"			
Bulb not included Lampadina non inclusa			

Net weight/Peso netto: 1.50 kg Pack/Colli: 2

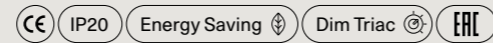

Volum 29 **NEW**

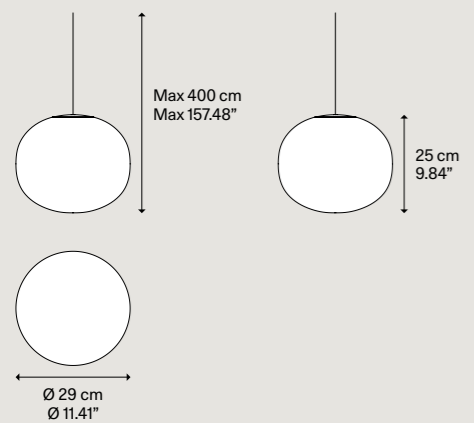

Light source Sorgente luminosa	Methacrylate structure Struttura in metacrilato	Blown glass diffuser Diffusore in vetro soffiato	Code Codice
E27 A60 LED ↘ 1 × 25 W	Glossy White Bianco Lucido	Glossy White Bianco Lucido	18713 1200
Ø max 9.8 cm - 3.74"			
Bulb not included Lampadina non inclusa			

Net weight/Peso netto: 2.20 kg Pack/Colli: 2

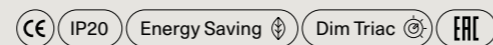

Example of composition 5 Lights Round

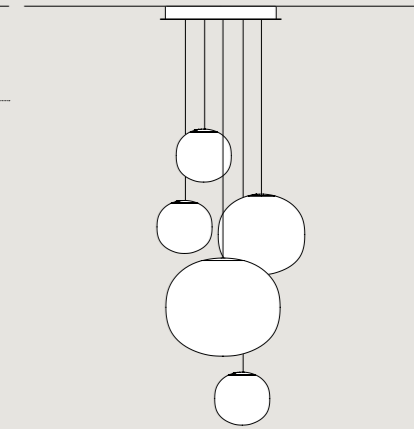
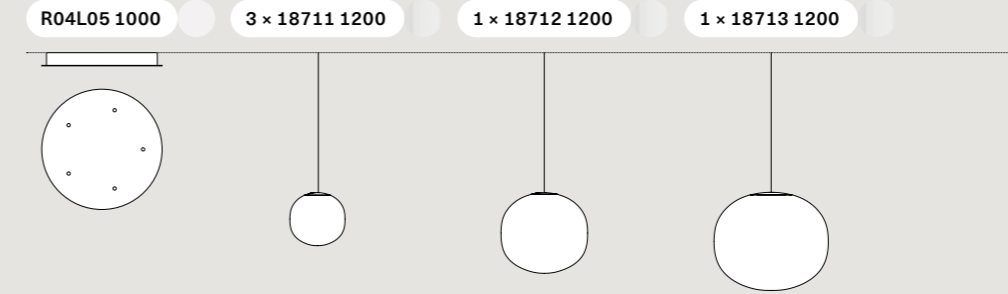

Example of composition 7 Lights Rectangular

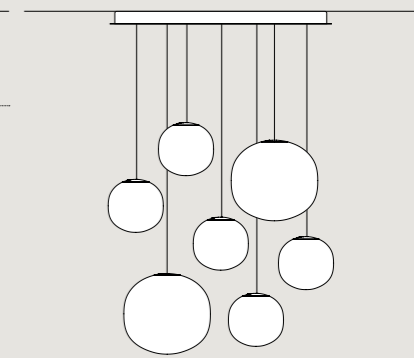
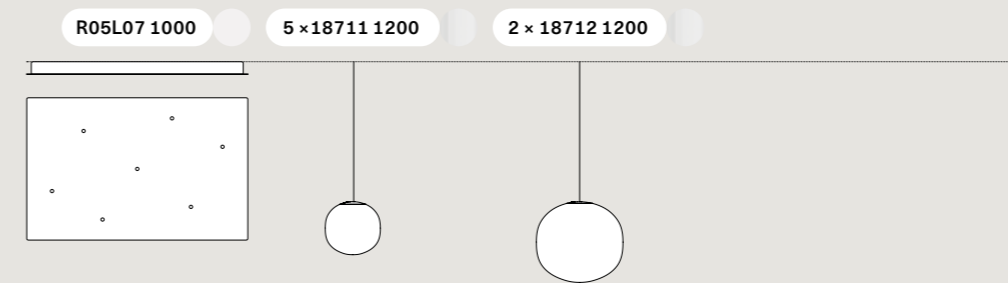

Example of composition Short Lights Track

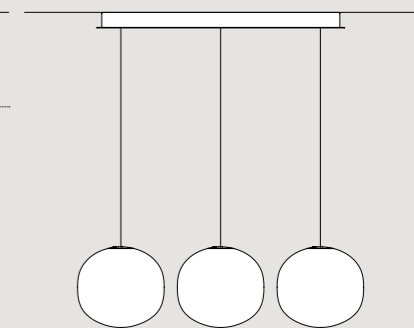
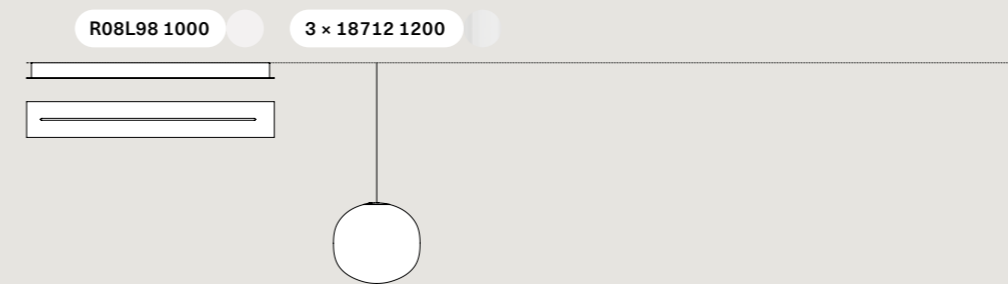

Suspension lamps must be installed on a canopy ▶ pag. 396-405
Le lampade a sospensione devono essere installate su rosone ▶ pag. 396-405

Random

A lightweight, blown glass suspension light, Random is made up of three round diffusers of different sizes which form one simple, eye-catching whole. Each diffuser has an LED light source which emits warm white light. When grouped together on a cluster, Random light fixtures form a poetic composition like soap bubbles, enhanced by the glossy coloured finishes which add a touch of character and originality.

Leggerissima lampada a sospensione in vetro soffiato, Random è composta da tre diffusori sferici di dimensioni diverse che formano un'entità semplice e vivace. Ogni diffusore è dotato di una sorgente luminosa a LED che fornisce una calda luce bianca. Raggruppate su cluster le lampade Random danno vita a composizioni poetiche come giochi di bolle di sapone, che le finiture lucide sfumate arricchiscono di carattere e originalità.

Cluster suspension lamp

Random,
FINISH Frosted White

Random, *design by Chia-Ying Lee, 2017*





Random, composition of 7 lights on a *long track*,
FINISHES Glossy Smoke and Clear



Random, FINISH Clear

Random, composition
of 36 lights on a *round canopy*,
FINISHES Clear and Chrome





Random, composition of 6 lights on a *radial canopy*, FINISHES Frosted White and Gold

Random, *recessed micro canopies*, FINISH Clear



Random, composition of 14 lights
on a *rectangular canopy*, FINISH Rose Gold



Random, FINISH Rose Gold

Suspension très légère en verre soufflé, Random est composée de trois diffuseurs sphériques de différentes tailles formant une entité simple et vivante. Chaque diffuseur est équipé d'une source lumineuse LED qui fournit une lumière blanche chaude. Regroupées en cluster, les lampes Random donnent vie à des compositions poétiques telles que des jeux de bulles de savon, dont les finitions douces et ombragées enrichissent le caractère et l'originalité. ●FR

Random ist eine ultraleichte Hängeleuchte aus geblasenem Glas und besteht aus drei kugelförmigen Diffusoren in unterschiedlicher Größe, die eine einfache und lebhafte Einheit bilden. Jeder Diffusor verfügt über eine LED-Lichtquelle, die warmweißes Licht abstrahlt. In Clustern angeordnet, lassen die Leuchten Random poetische Kombinationen entstehen, die einem Spiel aus Seifenblasen ähneln und denen die glänzenden, nuancierten Ausführungen Charakter und Originalität verleihen. ●DE

Lámpara muy ligera colgante de vidrio soplado, Random está compuesta de tres difusores esféricos de diferentes dimensiones que forman una entidad simple y dinámica. Cada difusor está equipado con una fuente luminosa de LED que proporciona una luz blanca cálida. Reagrupadas en grupos de lámparas colgantes Random dan vida a composiciones poéticas como juegos de pompas de jabón, que los acabados brillantes matizados enriquecen con carácter y originalidad. ●ES

Random – это легкий подвесной светильник из выдувного стекла, состоящий из трех сферических диффузоров разных размеров, которые образуют простую и живую композицию. Каждый диффузор оснащен светодиодным источником теплого белого света. Объединенные в кластеры лампы Random дают жизнь восхитительным композициям, таким как игра мыльных пузырей, а глянцевая отделка придает им своеобразный характер и оригинальность. ●RU

Random是一款非常轻盈的吹制玻璃吊灯，由三个不同尺寸的球形灯罩组成，形成简单活泼的整体。每一个灯罩都配有一个LED光源，提供白色的温暖灯光。集中在组合吊上，Random灯可形成诗意的组合，如同肥皂泡的嬉戏，光亮的色泽丰富了个性与原创性。●ZH

Visit website:



Random, design by Chia-Ying Lee, 2017

Cluster suspension lamp

Random

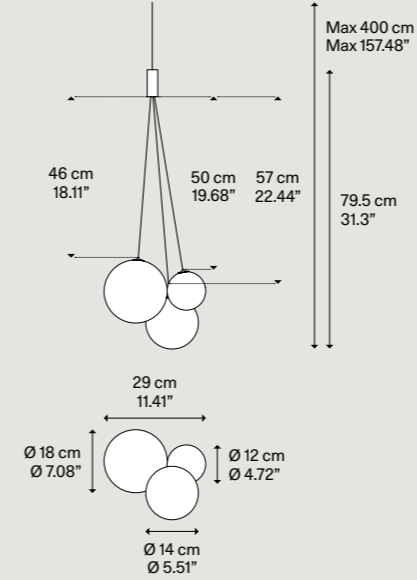

Light source
Sorgente luminosa

LED
 ▽ 2700 K
 ▽ 3 × 1 W / 450 lm
 ▽ 350 mA
 ▽ CRI 90
 ▽ MacAdam 3-Step

LED and driver included
LED e driver inclusi

or

LED
 ▽ 3000 K
 ▽ 3 × 1 W / 480 lm
 ▽ 350 mA
 ▽ CRI 90
 ▽ MacAdam 3-Step

LED and driver included
LED e driver inclusi

Metal structure
Montatura in metallo

Chrome
Cromo

Chrome
Cromo

Blown glass diffuser
Diffusore in vetro soffiato

Blown glass diffuser Diffusore in vetro soffiato	Code Codice
Clear Trasparente	16420 0027
Frosted White Bianco Satinato	16420 1327
Chrome Cromo	16420 4027
Glossy Smoke Fumo Lucido	16420 4327
Gold Oro	16420 5027
Rose Gold Oro Rosa	16420 5527
Clear Trasparente	16420 0030
Frosted White Bianco Satinato	16420 1330
Chrome Cromo	16420 4030
Glossy Smoke Fumo Lucido	16420 4330
Gold Oro	16420 5030
Rose Gold Oro Rosa	16420 5530

Net weight/Peso netto: 1.0 kg

Pack/Colli: 2

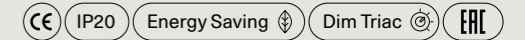

Suspension lamps must be installed on a canopy ► pag. 396–405
Le lampade a sospensione devono essere installate su rosone ► pag. 396–405

Example of composition

3 Lights Round

R04L03 1000 1 × 16420 1327 1 × 16420 4027 1 × 16420 5527

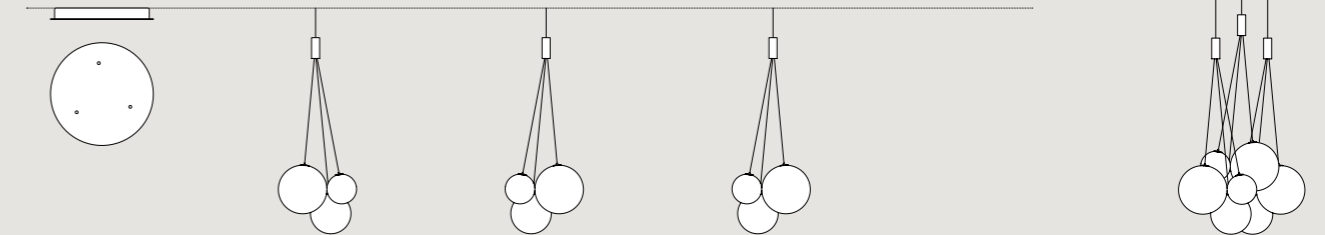

Example of composition

4 Lights Radial

R06L04 1000 4 × 999A4 00 2 × 16420 5027 2 × 16420 5527

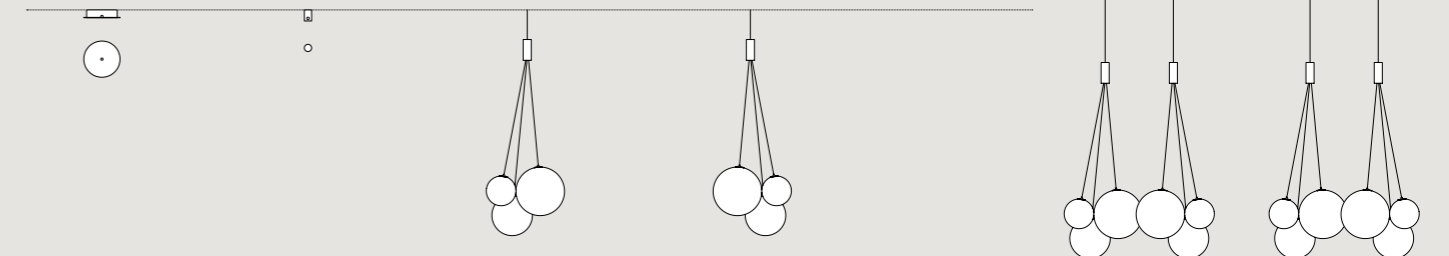

Random ▸ Cluster suspension lamp



Finishes ▸ Gradient effect

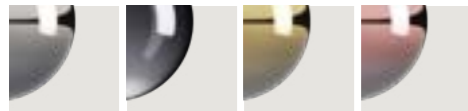

Random Solo

Five perfect spheres floating in the air like gentle glass bubbles. Random Solo revisits the concept of the Random suspension lamp by parting the original three-piece cluster and adding two new blown glass spheres.

The five sizes and six different finishes available offer ample styling freedom, both as individually suspended light points and in lightweight and lively combinations on clusters. The new fingerprint resistant frosted white finish magically changes the perception of the sphere and its volume, opening new opportunities for interior decoration.

Cinque sfere perfette che fluttuano nell'aria come leggere bolle di vetro. Random Solo rivisita il concetto della lampada a sospensione Random separando l'originale cluster a tre elementi e aggiungendo due nuove sfere in vetro soffiato. Le cinque dimensioni e le sei diverse finiture disponibili offrono ampia libertà di arredamento, sia come punti luce sospesi singolarmente che in leggere e vivaci composizioni multiple su cluster. La nuova finitura bianca satinata resistente alle impronte digitali cambia magicamente la percezione della sfera e del suo volume, aprendo nuove opportunità per la decorazione d'interni.

Cluster suspension lamp

Random Solo 28, 23 and 18,
FINISHES Frosted White, Glossy
Smoke and Clear

Random Solo, *design by Chia-Ying Lee, 2020*





Random Solo, composition on *round canopies* and single lights on *single canopies*, FINISHES Chrome and Clear



Random Solo 12, 14, 18, 23 and 28, FINISHES Clear and Glossy Smoke

Random Solo 23 and 28,
composition of 14 lights on a *round canopy*,
FINISHES Clear and Glossy Smoke



Random Solo 12, 14, 18, 23 and 28, *recessed micro canopies*, FINISHES Frosted White, Gold and Clear



Random Solo 28 and 23, FINISHES Clear and Rose Gold

Random Solo 14, 23 and 28,
composition of 5 lights on a *round canopy*
and single lights on *single mini canopies*,
FINISHES Clear and Rose Gold



Random Solo, FINISH Frosted White

Random Solo 23, composition of 4 lights
on a *long track*, FINISH Frosted White





Random Solo 18, composition of 7 lights on a *rectangular canopy*, FINISH Clear



Random Solo, FINISHES Glossy Smoke and Clear

Cinq sphères parfaites flottant dans l'air comme de légères bulles de verre. Random Solo revisite le concept de la lampe à suspension Random en séparant le cluster original à trois éléments et en ajoutant deux nouvelles sphères en verre soufflé. Les cinq tailles et les différentes finitions disponibles offrent une grande liberté d'aménagement, aussi bien sous forme de points lumineux suspendus individuellement que dans des compositions multiples légères et vivaces sur cluster. La nouvelle finition blanc satiné résistante aux empreintes digitales modifie comme par magie la perception de la sphère et de son volume, ouvrant de nouvelles possibilités pour la décoration d'intérieur. ● FR

Fünf perfekte Kugeln, die wie leichte Glasblasen in der Luft schweben. Random Solo ist das überarbeitete Konzept der Hängeleuchte Random, für die das originelle Cluster mit drei Elementen aufgeteilt wurde, um zwei neue Kugeln aus mundgeblasenem Glas hinzuzufügen. Die fünf Größen und sechs unterschiedlichen Ausführungen sorgen sowohl als einzeln hängende Lichtquellen wie auch als lebhaft Mehrfach-Kombinationen in Clustern für viel Freiheit beim Einrichten. Die neue, gegen Fingerabdrücke resistente Satin-Weiß Ausführung verändert auf magische Weise das Aussehen der Kugel und ihr Volumen und eröffnet neue Möglichkeiten für Innendekoration. ● DE

Cinco esferas perfectas que fluctúan en el aire como ligeras bolas de vidrio. Random Solo reinterpreta el concepto de la lámpara colgante Random separando el original grupo de lámparas colgantes en tres elementos y añadiendo dos nuevas esferas en vidrio soplado. Las cinco dimensiones y los diversos acabados disponibles ofrecen amplia libertad de decoración, tanto como puntos de luz colgantes individualmente como en ligeras y vivaces composiciones múltiple en grupo de lámparas colgantes. El nuevo acabado blanco satinado resistente a las huellas dactilares cambia mágicamente la percepción de la esfera y su volumen, abriendo nuevas oportunidades para la decoración de interiores. ● ES

Пять шаров совершенной формы, плавающих в воздухе как легкие стеклянные пузыри. Random Solo переосмысливает концепцию подвесного светильника Random, разделяя оригинальный кластер из трех элементов и добавляя два новых шара из выдувного стекла. Предлагаемые пять размеров с различными вариантами отделки обеспечивают широкую свободу оформления интерьера, как в виде отдельно подвешенных световых точек, так и в виде ярких и живых кластерных композиций. Новая устойчивая к отпечаткам пальцев белая сатирированная отделка волшебным образом меняет восприятие сферы и ее объем, открывая новые возможности декорирования интерьера. ● RU

五个完美的球体漂浮在空中，如同轻盈的玻璃泡。Random Solo 是Random吊灯的改进设计，将原来的三单元组合吊分离，增加了两个新的吹制玻璃球。五种尺寸和不同的颜色提供了室内装饰的自由选择，即可作为单独的照明点位，也可以应用在轻盈活泼的组合吊不同搭配中。● ZH

Visit website:



Random Solo 12 » Cluster suspension lamp



Random Solo 14 » Cluster suspension lamp



Random Solo 18 » Cluster suspension lamp



Random Solo 23 » Cluster suspension lamp



Random Solo 28 » Cluster suspension lamp

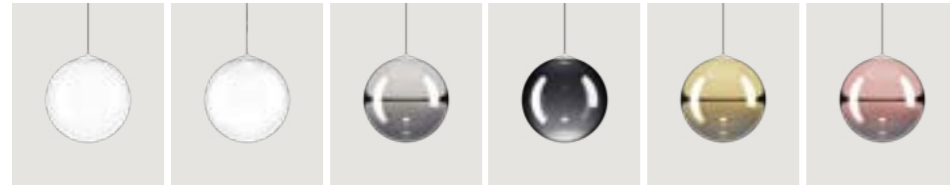

Finishes » Gradient effect



Random Solo, design by Chia-Ying Lee, 2020

Cluster suspension lamp

Random Solo 12

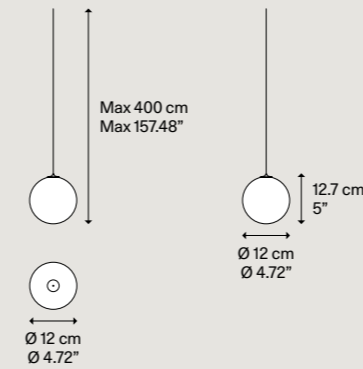

Light source
Sorgente luminosa

LED
» 2700 K
» 1 W / 150 lm
» 350 mA
» CRI 90
» MacAdam 3-Step

LED and driver included
LED e driver inclusi

or

LED
» 3000 K
» 1 W / 160 lm
» 350 mA
» CRI 90
» MacAdam 3-Step

LED and driver included
LED e driver inclusi

Blown glass diffuser
Diffusore in vetro soffiato

Code Codice	
Clear Trasparente	17111 0027
Frosted White Bianco Satinato	17111 1327
Chrome Cromo	17111 4027
Glossy Smoke Fumo Lucido	17111 4327
Gold Oro	17111 5027
Rose Gold Oro Rosa	17111 5527
Clear Trasparente	17111 0030
Frosted White Bianco Satinato	17111 1330
Chrome Cromo	17111 4030
Glossy Smoke Fumo Lucido	17111 4330
Gold Oro	17111 5030
Rose Gold Oro Rosa	17111 5530

Net weight/Peso netto: 0.25 kg

Pack/Colli: 2



Random Solo 14

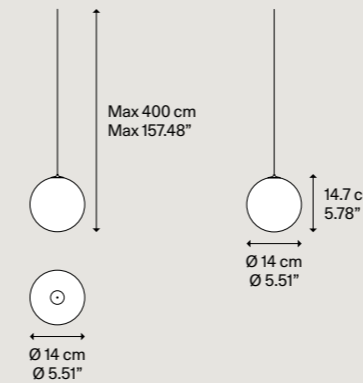

LED
» 2700 K
» 1 W / 150 lm
» 350 mA
» CRI 90
» MacAdam 3-Step

LED and driver included
LED e driver inclusi

or

LED
» 3000 K
» 1 W / 160 lm
» 350 mA
» CRI 90
» MacAdam 3-Step

LED and driver included
LED e driver inclusi

Clear Trasparente	17112 0027
Frosted White Bianco Satinato	17112 1327
Chrome Cromo	17112 4027
Glossy Smoke Fumo Lucido	17112 4327
Gold Oro	17112 5027
Rose Gold Oro Rosa	17112 5527
Clear Trasparente	17112 0030
Frosted White Bianco Satinato	17112 1330
Chrome Cromo	17112 4030
Glossy Smoke Fumo Lucido	17112 4330
Gold Oro	17112 5030
Rose Gold Oro Rosa	17112 5530

Net weight/Peso netto: 0.32 kg

Pack/Colli: 2

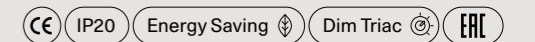

Random Solo, design by Chia-Ying Lee, 2020

Cluster suspension lamp

Random Solo 18

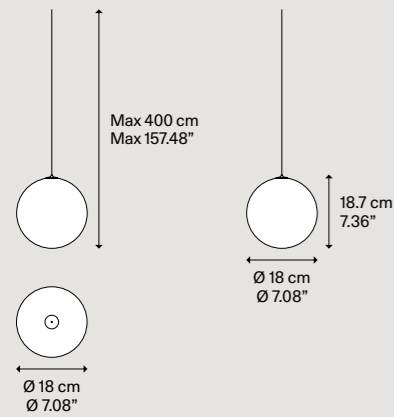

Light source Sorgente luminosa	Blown glass diffuser Diffusore in vetro soffiato	Code Codice
LED ↘ 2700 K ↘ 1 W / 150 lm ↘ 350 mA ↘ CRI 90 ↘ MacAdam 3-Step LED and driver included LED e driver inclusi	Clear Trasparente	17113 0027
	Frosted White Bianco Satinato	17113 1327
	Chrome Cromo	17113 4027
	Glossy Smoke Fumo Lucido	17113 4327
	Gold Oro	17113 5027
	Rose Gold Oro Rosa	17113 5527
	Clear Trasparente	17113 0030
	Frosted White Bianco Satinato	17113 1330
	Chrome Cromo	17113 4030
	Glossy Smoke Fumo Lucido	17113 4330
LED and driver included LED e driver inclusi	Gold Oro	17113 5030
	Rose Gold Oro Rosa	17113 5530

Net weight/Peso netto: 0.8 kg Pack/Colli: 2

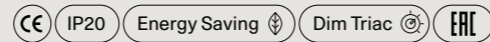

Random Solo 23

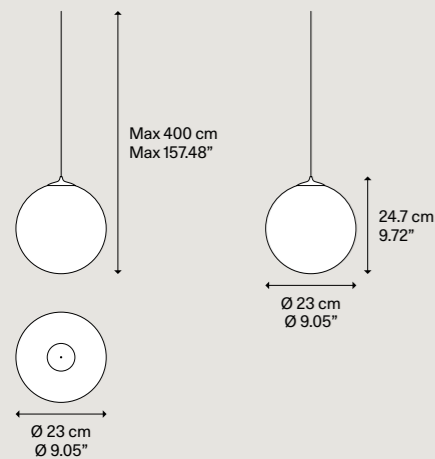

LED ↘ 2700 K ↘ 3 W / 450 lm ↘ 350 mA ↘ CRI 90 ↘ MacAdam 3-Step LED and driver included LED e driver inclusi	Clear Trasparente	17114 0027
	Frosted White Bianco Satinato	17114 1327
	Chrome Cromo	17114 4027
	Glossy Smoke Fumo Lucido	17114 4327
	Gold Oro	17114 5027
	Rose Gold Oro Rosa	17114 5527
	Clear Trasparente	17114 0030
	Frosted White Bianco Satinato	17114 1330
	Chrome Cromo	17114 4030
	Glossy Smoke Fumo Lucido	17114 4330
LED and driver included LED e driver inclusi	Gold Oro	17114 5030
	Rose Gold Oro Rosa	17114 5530

Net weight/Peso netto: 1.1 kg Pack/Colli: 2

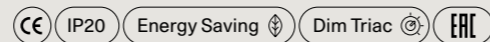

Random Solo, design by Chia-Ying Lee, 2020

Cluster suspension lamp

Random Solo 28

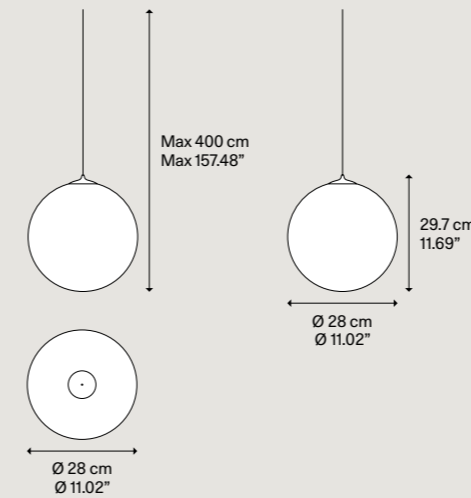

Light source Sorgente luminosa	Blown glass diffuser Diffusore in vetro soffiato	Code Codice
LED ↘ 2700 K ↘ 3 W / 450 lm ↘ 350 mA ↘ CRI 90 ↘ MacAdam 3-Step LED and driver included LED e driver inclusi	Clear Trasparente	17115 0027
	Frosted White Bianco Satinato	17115 1327
	Chrome Cromo	17115 4027
	Glossy Smoke Fumo Lucido	17115 4327
	Gold Oro	17115 5027
	Rose Gold Oro Rosa	17115 5527
	Clear Trasparente	17115 0030
	Frosted White Bianco Satinato	17115 1330
	Chrome Cromo	17115 4030
	Glossy Smoke Fumo Lucido	17115 4330
LED and driver included LED e driver inclusi	Gold Oro	17115 5030
	Rose Gold Oro Rosa	17115 5530

Net weight/Peso netto: 1.8 kg Pack/Colli: 2

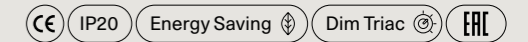

Suspension lamps must be installed on a canopy ▶ pag. 396-403
Le lampade a sospensione devono essere installate su rosone ▶ pag. 396-403

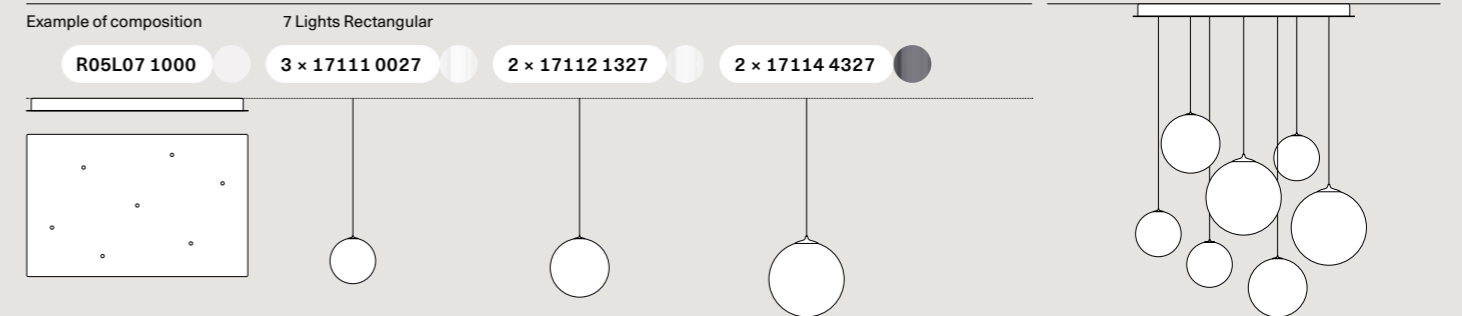

Jefferson

The Jefferson suspension lamp designed by Luca Nichetto is reminiscent of music and iconic images in psychedelic works of art from the 1960s. The vortex motif decorating the diffuser is embellished by the timeless classicism of Bohemian crystal, which diffuses evocative atmospheres of light. Dynamic in its many sizes and multiple compositions, Jefferson's elegance keeps up with the excellent performance of LED interior lighting.

La lampada a sospensione Jefferson disegnata da Luca Nichetto rimanda alla musica e alle immagini iconiche in opere d'arte psichedeliche degli anni Sessanta. Il motivo a vortice che decora il diffusore è impreziosito dalla classicità senza tempo del cristallo di Boemia, che diffonde suggestive atmosfere di luce. Dinamica nelle diverse dimensioni e in composizioni multiple, l'eleganza di Jefferson non rinuncia alle eccellenti prestazioni della luce interna a LED.

Cluster suspension lamp

Jefferson small, medium and mini,
FINISH Clear + Gold

Jefferson, *design by* Luca Nichetto, 2019





Jefferson Mini, composition of 30 lights on a *round canopy*, FINISHES Clear and Chrome



Jefferson mini, small and medium,
special composition of 68 lights,
FINISH Clear + Gold





Jefferson mini, FINISH Clear + Black Chrome

Jefferson mini, small and medium,
composition of 5 lights on a
round canopy, FINISH Clear + Gold

La lampe à suspension Jefferson dessinée par Luca Nichetto fait référence à la musique et aux images emblématiques des œuvres d'art psychédélics des années soixante. Le motif vortex qui orne le diffuseur est rehaussé par le classicisme intemporel du cristal de Bohême, qui diffuse des atmosphères de lumière suggestives. Dynamique dans différentes tailles et dans de multiples compositions, l'élégance de Jefferson ne renonce pas aux excellentes performances de l'éclairage intérieur LED. ● FR

La lámpara colgante Jefferson diseñada por Luca Nichetto hace referencia a la música y a las imágenes icónicas en obras de arte psicodélicas de los años sesenta. El motivo en espiral que decora el difusor está embellecido por el estilo clásico sin tiempo del cristal de Bohemia, que difunde atmósferas sugestivas de luz. Dinámica en los diferentes tamaños y en composiciones múltiples, la elegancia de Jefferson no renuncia a las excelentes prestaciones de la luz interna de LED. ● ES

Luca Nichetto受上世纪六十年代迷幻视觉艺术的音乐和图案的启发设计了吊灯Jefferson。灯罩上装饰的漩涡图案因波西米亚水晶的永恒古典主义更显精美珍贵，将迷人的光线散发开来。Jefferson吊灯具有不同尺寸和多种组成的动态变化，精美雅致的同时更良好利用了内置LED灯的优秀性能。● ZH

Die von Luca Nichetto entworfene Hängeleuchte „Jefferson“ erinnert an die Musik und die ikonischen Darstellungen in psychedelischen Kunstwerken der sechziger Jahre. Die Wirbel-Optik des Diffusors wird aufgewertet durch den klassisch-zeitlosen Stil des böhmischen Kristalls, das suggestive Lichtstimmungen erzeugt. Erhältlich in verschiedenen Größen und vielfältigen Kompositionen, verzichtet die Eleganz von Jefferson nicht auf die hervorragende Leistung der LED-Innenbeleuchtung. ● DE

Подвесной светильник Jefferson, дизайн Лука Никетто, вызывает в памяти музыку и культовые изображения на психоделических произведениях шестидесятых годов. Ценность вихревому украшению диффузора придает вечная классика богемского хрусталя, благодаря которому создается необыкновенная световая атмосфера. Элегантная и динамичная за счет различных размеров и множественных комбинаций модель Jefferson не отказывается от превосходных характеристик внутреннего светодиодного освещения. ● RU

Visit website:



Jefferson mini ▸ Cluster suspension lamp



Jefferson small ▸ Cluster suspension lamp



Jefferson medium ▸ Cluster suspension lamp



Jefferson, design by Luca Nichetto, 2019

Cluster suspension lamp

Jefferson mini

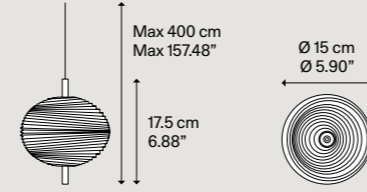

Net weight/Peso netto: 1.40 kg

Pack/Colli: 1

Light source
Sorgente luminosa

LED
▸ 2700 K
▸ 3 W/450 lm
▸ 350 mA
▸ CRI 90
▸ MacAdam 3-Step

LED and driver included
LED e driver inclusi

Metal structure
Montatura in metallo

● Black Chrome
Cromo Nero

● Gold
Oro

Bohemian crystal diffuser
Diffusore in cristallo di Boemia

● Clear
Trasparente

● Clear
Trasparente

Code
Codice

16821 4227

16821 5027

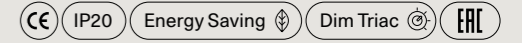

Jefferson small

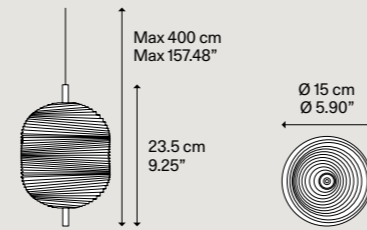

Net weight/Peso netto: 2.10 kg

Pack/Colli: 1

LED
▸ 2700 K
▸ 3 W/450 lm
▸ 350 mA
▸ CRI 90
▸ MacAdam 3-Step

LED and driver included
LED e driver inclusi

● Black Chrome
Cromo Nero

● Gold
Oro

● Clear
Trasparente

● Clear
Trasparente

16822 4227

16822 5027

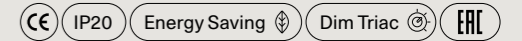

Jefferson medium

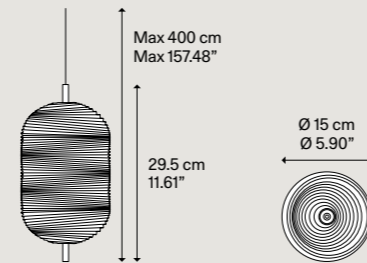

Net weight/Peso netto: 2.80 kg

Pack/Colli: 1

LED
▸ 2700 K
▸ 3 W/450 lm
▸ 350 mA
▸ CRI 90
▸ MacAdam 3-Step

LED and driver included
LED e driver inclusi

● Black Chrome
Cromo Nero

● Gold
Oro

● Clear
Trasparente

● Clear
Trasparente

16823 4227

16823 5027

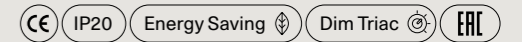

Suspension lamps must be installed on a canopy ▶ pag. 396-403
Le lampade a sospensione devono essere installate su rosone ▶ pag. 396-403

Example of composition

3 Lights Round

R04L03 1000 1 × 16821 5027 1 × 16822 5027 1 × 16823 5027

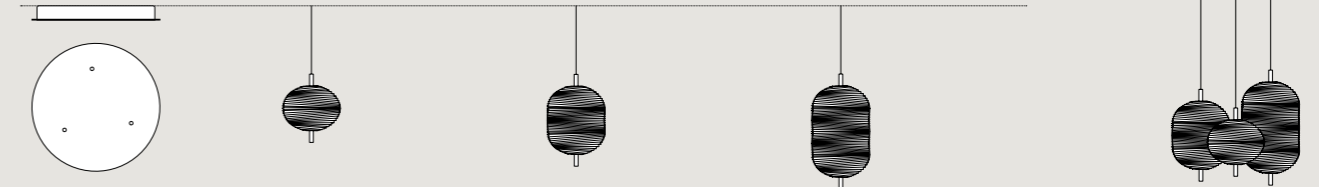

Nostalgia

With its retro flair, Nostalgia elegantly tells of ancient glass blowing practices in three sinuous forms that can be combined at will. The perfection of the glass, the innovative LED technology and six elegant finishes make Nostalgia an extremely modern and versatile lamp that lends itself to the creation of captivating atmospheres, whether on or off.

Con il suo sapore retrò, Nostalgia racconta con eleganza antiche storie di vetro soffiato in tre forme sinuose che possono essere combinate a piacere. La perfezione del vetro, l'innovativa tecnologia LED e le sei raffinate finiture fanno di Nostalgia una lampada estremamente contemporanea e versatile che permette di creare atmosfere affascinanti sia da accesa che da spenta.

Cluster suspension lamp

Nostalgia medium, large and small,
FINISH Glossy Bronze

Nostalgia, *design by* Dima Loginoff, 2015





Nostalgia small, medium and large, composition of 14 lights on a *rectangular canopy*

FINISHES Clear, Glossy Bronze and Glossy Smoke



Nostalgia medium, small and large, FINISH Clear

Nostalgia small, medium and large,
composition of 24 lights on a *round canopy*,
FINISHES Clear and Glossy Smoke





Nostalgia small, medium and large, special composition of 82 lights on *recessed micro canopies*

FINISHES Clear, Chrome and Gold

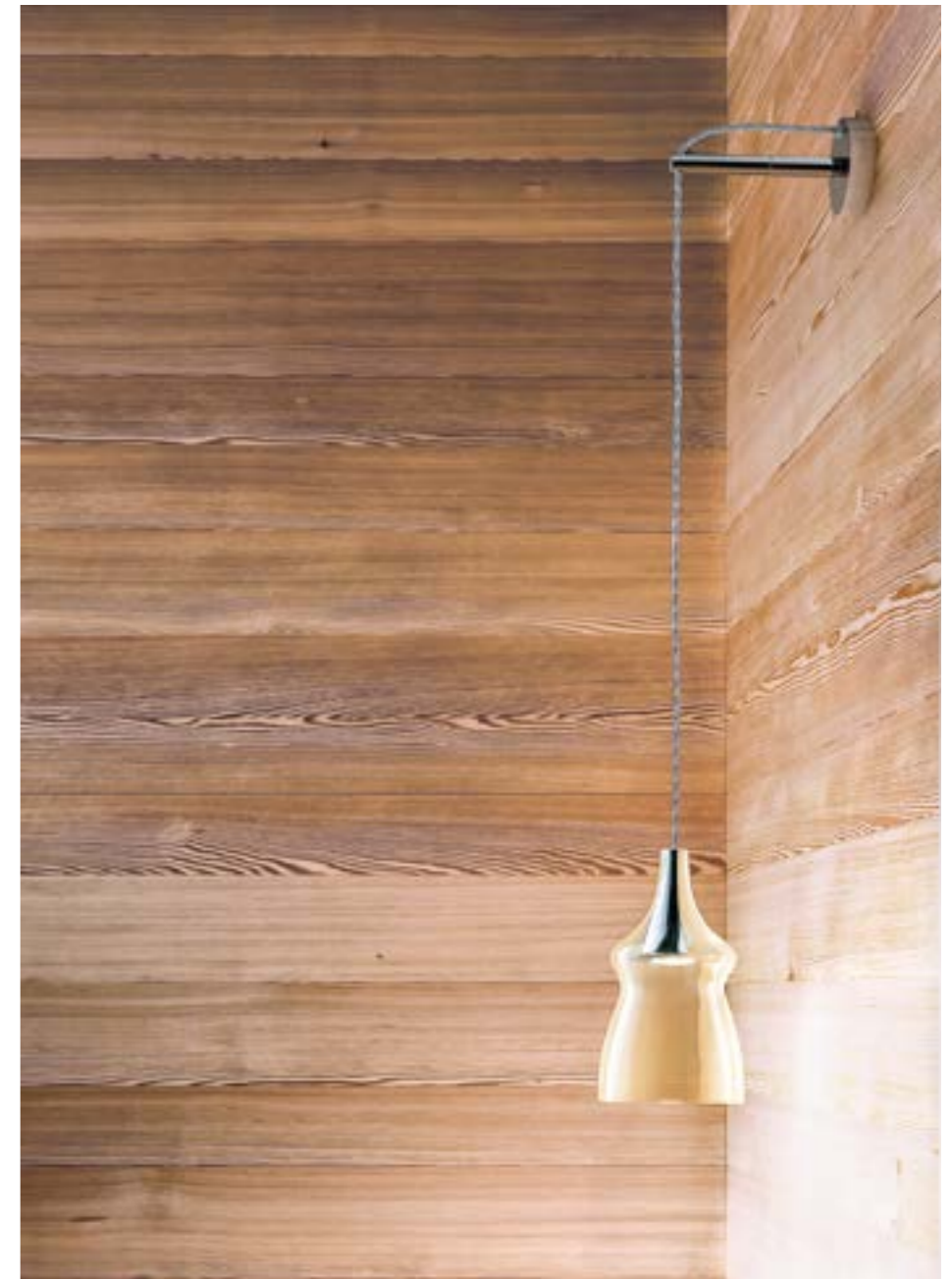

Nostalgia small on a *wall canopy*, FINISH Clear

Nostalgia small, medium and large,
composition of 5 lights on a *long track*,
FINISH Clear



Nostalgia large, composition of 7 lights on a round canopy, FINISH Rose Gold

Avec son charme rétro, Nostalgia raconte avec élégance d'anciennes histoires de verre soufflé en trois formes sinueuses qui peuvent être combinées à souhait. La perfection du verre, l'innovante technologie LED et ses finitions raffinées font de Nostalgia une lampe très contemporaine et polyvalente qui permet de créer une atmosphère fascinante qu'elle soit éclairée ou éteinte. ● FR

Mit ihrem Retro-Stil erzählt Nostalgia mit Eleganz alte Geschichten von mundgeblasenem Glas in drei geschwungenen Formen, die nach Belieben kombiniert werden können. Die Perfektion des Glases, die innovative LED-Technologie und die sechs raffinierten Ausführungen machen aus Nostalgia eine besonders moderne und vielseitige Lampe, die sowohl ein- wie auch ausgeschaltet faszinierende Atmosphären schafft. ● DE

Con su sabor retro, Nostalgia cuenta con elegancia antiguas historias de vidrio soplado en tres formas sinuosas que pueden combinarse a voluntad. La perfección del vidrio, la innovadora tecnología LED y los seis refinados acabados hacen de Nostalgia una lámpara extremadamente contemporánea y versátil que permite crear fascinantes atmósferas tanto encendida como apagada. ● ES

Выполненный в стиле ретро, светильник Nostalgia изящно повествует о древней истории выдувного стекла, представая в трех изогнутых объемных формах, которые можно комбинировать по собственному вкусу. Совершенство стекла, инновационная технология LED и шесть вариантов изысканной отделки делают светильник Nostalgia необыкновенно современным и универсальным, позволяющим создавать чарующую атмосферу как во включенном, так и в выключенном виде. ● RU

Nostalgia具有复古气息，优雅地讲述了吹制玻璃的三种古老形状，可以任意组合。玻璃的完美表现，创新的LED技术和六种精致的颜色，使Nostalgia成为一款极为现代且用途广泛的灯具，让您在开与关之间营造出迷人的氛围。● ZH

Visit website:



Nostalgia small › Cluster suspension lamp

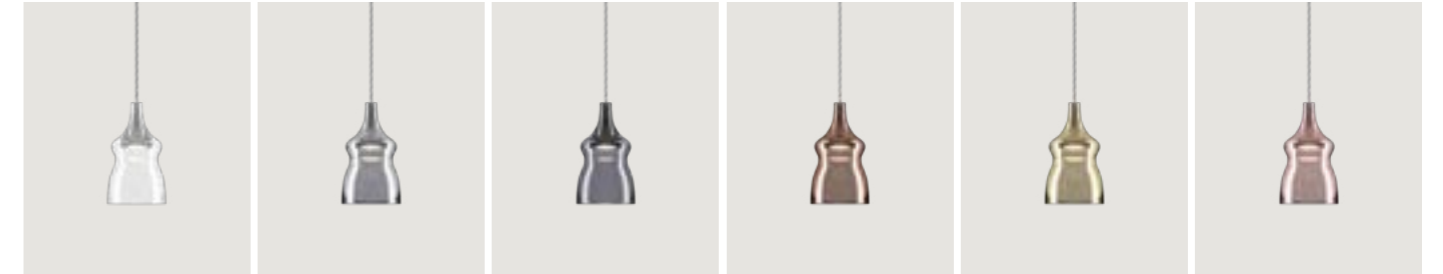

Nostalgia medium › Cluster suspension lamp

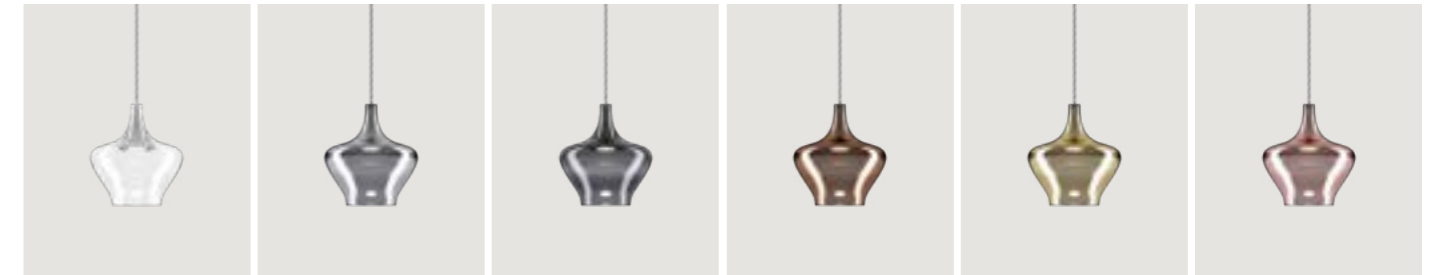

Nostalgia large › Cluster suspension lamp

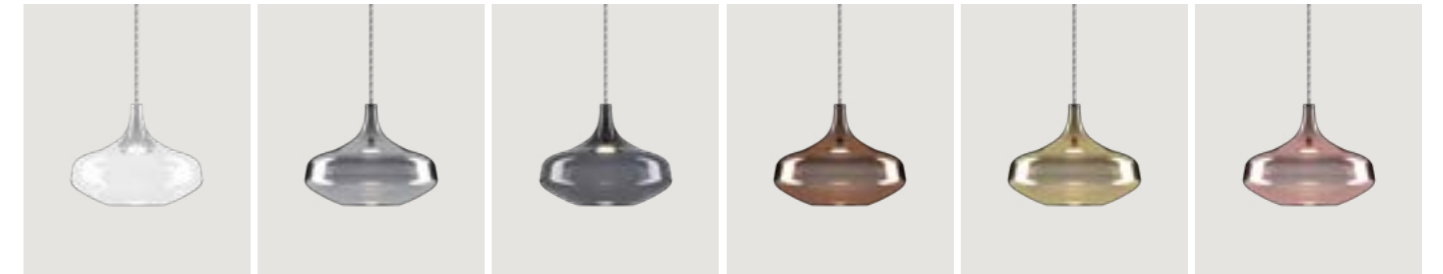

Cluster suspension lamp

Nostalgia small

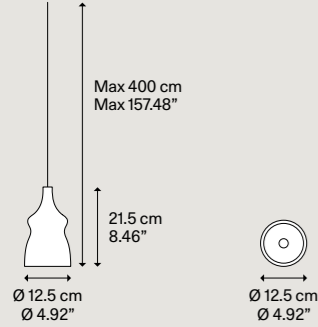

Light source
Sorgente luminosa

LED
 ↘ 2700 K
 ↘ 7.2 W/830 lm
 ↘ 220-240 V
 ↘ CRI 92
 ↘ MacAdam 3-Step

LED included
LED incluso

Metal structure
Montatura in metallo

Chrome Cromo

Blown glass diffuser
Diffusore in vetro soffiato

Clear Trasparente	15422 0027
Chrome Cromo	15422 4027
Glossy Smoke Fumo Lucido	15422 4327
Glossy Bronze Bronzo Lucido	15422 4627
Gold Oro	15422 5027
Rose Gold Oro Rosa	15422 5527

Net weight/Peso netto: 0.66 kg Pack/Coll: 2

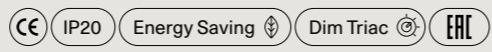

Nostalgia medium

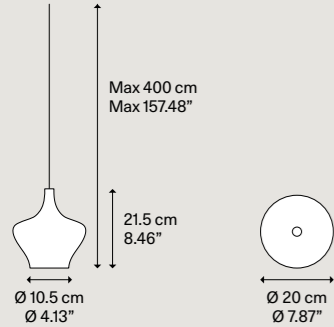

LED
 ↘ 2700 K
 ↘ 7.2 W/830 lm
 ↘ 220-240 V
 ↘ CRI 92
 ↘ MacAdam 3-Step

LED included
LED incluso

Chrome Cromo

Clear Trasparente	15423 0027
Chrome Cromo	15423 4027
Glossy Smoke Fumo Lucido	15423 4327
Glossy Bronze Bronzo Lucido	15423 4627
Gold Oro	15423 5027
Rose Gold Oro Rosa	15423 5527

Net weight/Peso netto: 0.75 kg Pack/Coll: 2

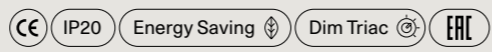

Nostalgia large

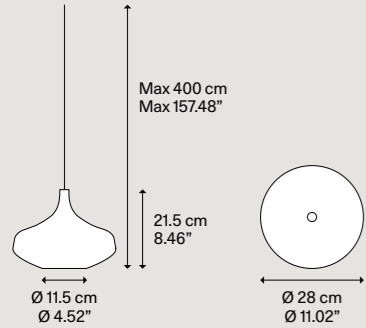

LED
 ↘ 2700 K
 ↘ 7.2 W/830 lm
 ↘ 220-240 V
 ↘ CRI 92
 ↘ MacAdam 3-Step

LED included
LED incluso

Chrome Cromo

Clear Trasparente	15424 0027
Chrome Cromo	15424 4027
Glossy Smoke Fumo Lucido	15424 4327
Glossy Bronze Bronzo Lucido	15424 4627
Gold Oro	15424 5027
Rose Gold Oro Rosa	15424 5527

Net weight/Peso netto: 1.02 kg Pack/Coll: 2

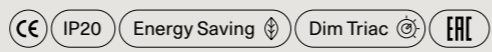

Suspension lamps must be installed on a canopy ► pag. 396-405
Le lampade a sospensione devono essere installate su rosone ► pag. 396-405

Example of composition

7 Lights Rectangular

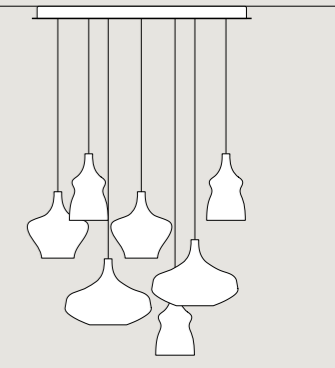
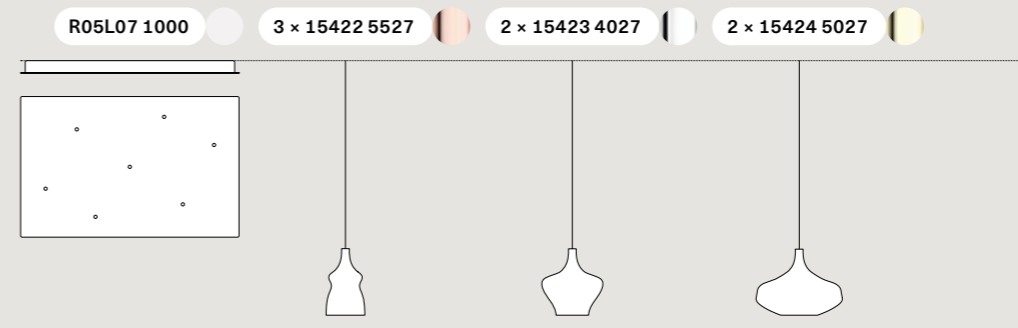

Example of composition

14 Lights Round

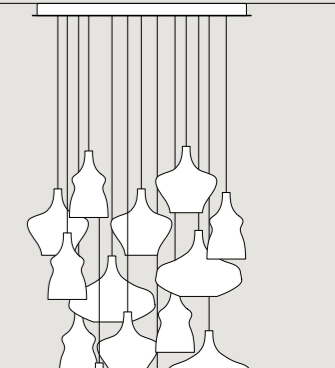
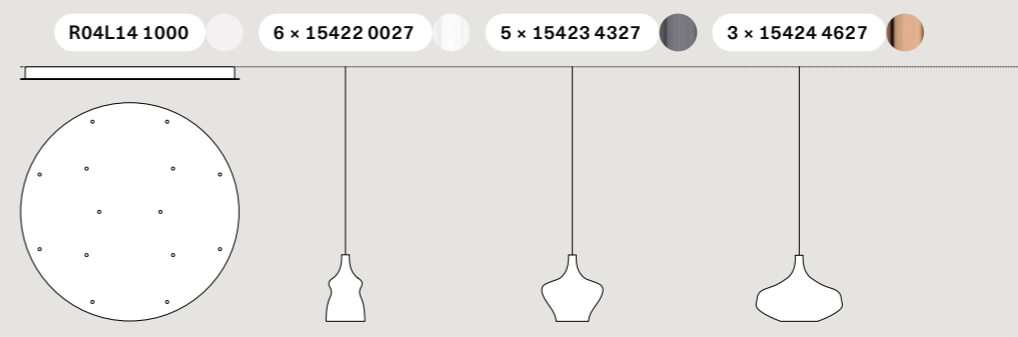

Example of composition

Short Lights Track

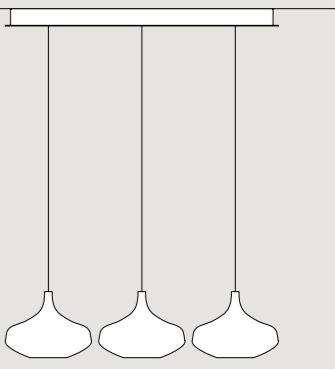
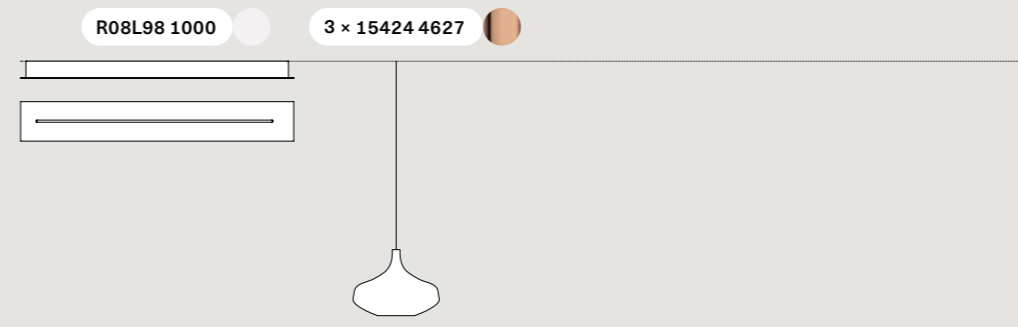

LED module with direct power supply to the AC line voltage - driver not required. Dimmable with phase cut dimmer.

LED con alimentazione diretta a tensione di rete - non necessita di driver. Dimmerabile con varialuce a taglio di fase.

Sky-Fall

In Sky-Fall, the traditional glass processing techniques embrace the most advanced LED technologies. The shape of Sky-Fall captures the imagination in its reminiscence of ancient decanters in precious blown glass. Its function amazes thanks to the innovative double LED source that diffuses direct and indirect light. Available in two sizes and in five finishes, Sky-Fall decorates both when it is on and when it is off.

In Sky-Fall le tradizionali tecniche di lavorazione del vetro abbracciano le tecnologie LED più avanzate. La forma di Sky-Fall emoziona ricordando antichi decanter in prezioso vetro soffiato. La sua funzione stupisce grazie all'innovativa doppia sorgente a LED che diffonde luce diretta e indiretta. Disponibile in due dimensioni e in cinque finiture, Sky-Fall arreda sia da accesa che da spenta.

Suspension lamp

Sky-Fall large and medium,
FINISH Glossy Smoke

Sky-Fall, *design by* Studio Italia Design, 2014





Sky-Fall medium,
FINISH Chrome



Sky-Fall large and medium, FINISH Clear



Sky-Fall, FINISH Clear

Sky-Fall large and medium,
FINISH Glossy Smoke





Sky-Fall medium and large, single and wall canopies, FINISHES Clear and Rose Gold

Sky-Fall medium and large,
FINISH Glossy Bronze





Sky-Fall medium, FINISH Clear

Chez Sky-Fall, les techniques traditionnelles de travail du verre adoptent les technologies LED les plus pointues. La forme de Sky-Fall passionne en rappelant d'anciennes décanteurs en verre soufflé précieux. Son fonctionnement étonne grâce à la double source LED innovante qui diffuse une lumière directe et indirecte. Disponible en deux tailles et cinq finitions, Sky-Fall décore aussi bien allumée qu'éteinte. ●FR

Bei Sky-Fall treffen traditionelle Glasverarbeitungstechniken auf fortschrittlichste LED-Technologien. Die Form von Sky-Fall begeistert und erinnert an alte Dekanter aus hochwertigem, geblasenem Glas. Die Funktion der Lampe beeindruckt dank der innovativen, doppelten LED-Lichtquelle, die gleichzeitig für direkte und indirekte Beleuchtung sorgt. In zwei Größen und mit fünf Oberflächen verfügbar, ist Sky-Fall sowohl ein- wie auch ausgeschaltet ein schöner Einrichtungsgegenstand. ●DE

En Sky-Fall las tradicionales técnicas de elaboración del vidrio abrazan las tecnologías LED más avanzadas. La forma de Sky-Fall emociona recordando antiguos decantadores en precioso vidrio soplado. Su función impacta gracias a la innovadora doble fuente de LED que difunde luz directa e indirecta. Disponible en dos dimensiones y en cinco acabados, Sky-Fall decora tanto encendida como apagada. ●ES

В светильниках Sky-Fall традиционные методы обработки стекла сливаются воедино с самыми передовыми светодиодными технологиями. Форма светильника Sky-Fall, напоминающая старинные декантеры для вина из ценного дутого стекла, пробуждает эмоции. Его функциональность, обеспечиваемая инновационным двойным светодиодным источником с прямым и непрямым распределением света, впечатляет. Светильник Sky-Fall доступен в двух размерах и в пяти вариантах отделки и украшает интерьер как во включенном, так и в выключенном состоянии. ●RU

Sky-Fall融汇了传统玻璃工艺与最先进的LED技术。Sky-Fall的形状令人联想起以珍贵吹制玻璃制成的古老酒壶。创新的双LED光源，分别发出直接和间接灯光，功能令人惊喜。可提供两种尺寸，五种表面处理，Sky-Fall无论在点亮或熄灭时，都发挥着装饰功能。●ZH

Visit website:



Sky-Fall medium › Suspension lamp

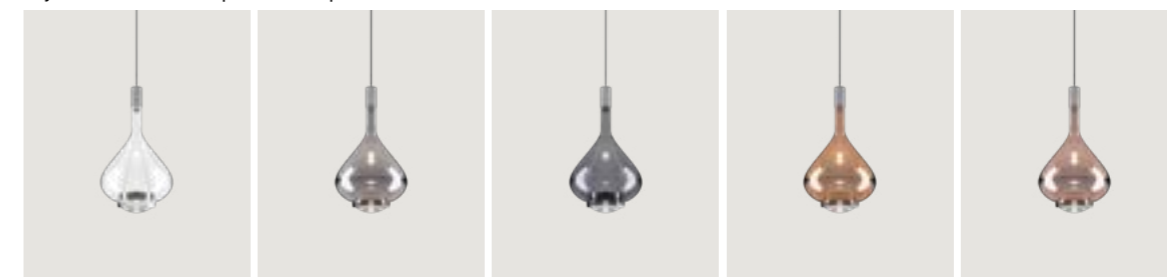

Sky-Fall large › Suspension lamp

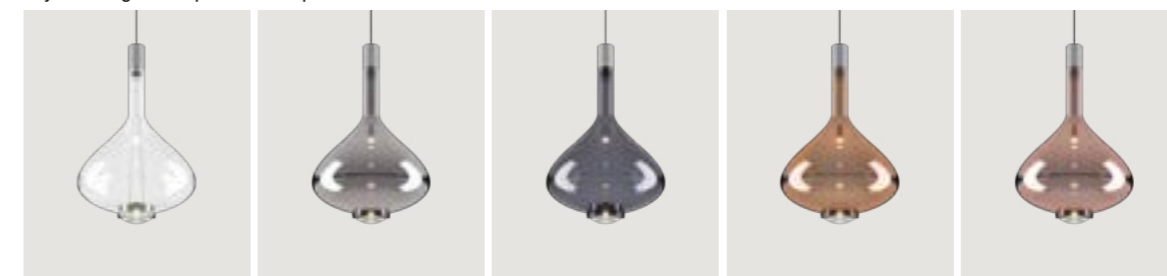

Sky-Fall, design by Studio Italia Design, 2014

Suspension lamp

Sky-Fall medium

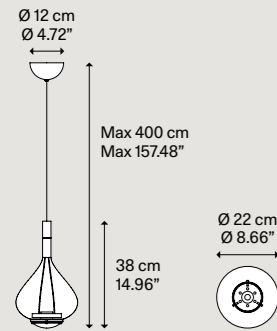

Light source
Sorgente luminosa

LED
 ↘ 2700 K
 ↘ 2 × 10 W / 1815 lm
 ↘ 350 mA
 ↘ CRI 95
 ↘ MacAdam 3-Step

Metal structure
Montatura in metallo

Chrome Cromo

Blown glass diffuser
Diffusore in vetro soffiato

Clear Trasparente	14822 0027
Chrome Cromo	14822 4027
Glossy Smoke Fumo Lucido	14822 4327
Glossy Bronze Bronzo Lucido	14822 4627
Rose Gold Oro Rosa	14822 5527

Code
Codice

LED and driver included
LED e driver inclusi

Net weight/Peso netto: 1.65 kg Pack/Colli: 2

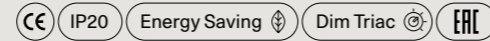

Sky-Fall large

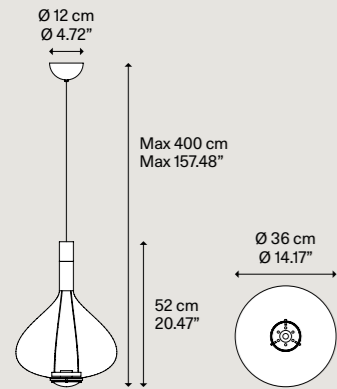

Light source
Sorgente luminosa

LED
 ↘ 2700 K
 ↘ 2 × 10 W / 1815 lm
 ↘ 350 mA
 ↘ CRI 95
 ↘ MacAdam 3-Step

Metal structure
Montatura in metallo

Chrome Cromo

Blown glass diffuser
Diffusore in vetro soffiato

Clear Trasparente	14821 0027
Chrome Cromo	14821 4027
Glossy Smoke Fumo Lucido	14821 4327
Glossy Bronze Bronzo Lucido	14821 4627
Rose Gold Oro Rosa	14821 5527

Code
Codice

LED and driver included
LED e driver inclusi

Net weight/Peso netto: 3.05 kg Pack/Colli: 2

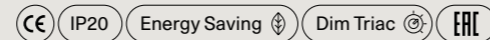

Sky-Fall, design by Studio Italia Design, 2014

Canopy

Double canopy Sky-Fall

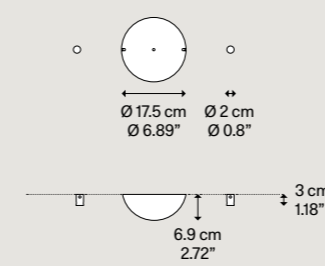

Net weight/Peso netto: 0.90 kg Pack/Colli: 1



Wall Bracket

Sky-Fall wall

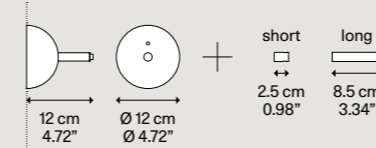

Net weight/Peso netto: 0.4 kg Pack/Colli: 1



WALL ► Both accessories in the two available lengths are supplied in the box with the wall bracket.

WALL ► Entrambi gli accessori nelle due diverse lunghezze sono inclusi nella confezione con il supporto a parete.

Flar

The name *Flar* evokes images of a flare or ‘flamboiemment’ in French – an intense blaze or burst of light. Inspired by traditional storm lanterns which use glass pipes to protect the flame, *Flar* comprises a 3D laser cut steel base which opens like a flower, leading to a charmingly imperfect blown glass diffuser available in two sizes, 45 and 60 cm. *Flar* features a dimmer controlled with the cable mounted power switch, allowing users to modulate the intensity of the light to create their ideal lighting scheme. The two sizes offer an opportunity to play with scale to create a unique composition for a hotel lounge or retail space.

Il nome *Flar* evoca l’immagine di uno sfavillio o “flamboiemment”, che in francese indica un intenso bagliore o squarcio di luce. Ispirata alle tradizionali lanterne antivento dotate di tubi in vetro per proteggere la fiamma, *Flar* si poggia su una base in acciaio, realizzata con la tecnologia del taglio laser 3D, che si schiude come un fiore e accoglie un diffusore in vetro soffiato dall’effetto piacevolmente imperfetto. Disponibile nelle due versioni da 45 e 60 cm, *Flar* è provvista di un varialuce regolabile dall’interruttore montato sul cavo, che consente all’utente di modulare l’intensità della luce in base alle proprie preferenze. Le due dimensioni offrono la possibilità di giocare con le proporzioni, creando così composizioni uniche nelle aree lounge degli hotel o nei punti vendita.

Table lamp, Floor lamp

Flar large and medium,
FINISHES Terra + Honey and
Champagne + Turquoise

Flar, *design by* Patrick Norguet, 2022





Flar medium and large, FINISHES Champagne + Honey and Champagne + Turquoise



Flar, blown glass diffuser, FINISHES Honey and Turquoise



Flar, 3D laser cut base, FINISH: Champagne

Flar medium and large,
FINISHES Champagne + Honey
and Terra + Turquoise





Flar medium and large, FINISHES Terra + Turquoise and Terra + Honey



Flar, 3D laser cut base, FINISH: Terra

Le nom *Flar* évoque un flamboiement (Flare en anglais) – une flamme intense ou un éclat de lumière. S'inspirant des lanternes tempête traditionnelles qui utilisent des cylindres de verre pour protéger la flamme, *Flar* se compose d'une base en acier découpée au laser 3D qui s'épanouit comme une fleur, portant à un diffuseur en verre soufflé d'une séduisante imperfection disponible en deux tailles, 45 et 60 cm. *Flar* dispose d'un variateur contrôlé par l'interrupteur d'alimentation monté sur câble, permettant à l'utilisateur de moduler l'intensité de la lumière pour créer l'éclairage idéal. Les deux tailles offrent la possibilité de jouer avec les variations pour une composition unique dans un hall d'hôtel ou un magasin. ● FR

Der Name *Flar* erinnert an eine Fackel oder 'flamboiement' im Französischen – ein intensives Aufblitzen oder Ausbrechen von Licht. Inspiriert von traditionellen Sturmlaternen, die Glasrohre zum Schutz der Flamme verwenden, besteht *Flar* aus einer 3D-gelasierten Basis aus Stahl, die sich wie eine Blume öffnet und sich zu einem bezaubernden nicht perfekten Diffusor aus mundgeblasenem Glas entwickelt, der in zwei Größen erhältlich ist: 45 und 60 cm. *Flar* ist mit einem Dimmer ausgestattet, der über den am Kabel angebrachten Netzschalter gesteuert wird und es dem Benutzenden ermöglicht, die Intensität des Lichts zu modulieren, um das ideale Beleuchtungsschema zu schaffen. Die beiden Größen bieten die Möglichkeit, mit dem Maßstab zu spielen und eine einzigartige Komposition für eine Hotellounge oder einen Verkaufsraum zu schaffen. ● DE

El nombre *Flar* recoge ecos del término francés «flamboiement», una llamarada o un intenso estallido de luz. Inspirada por las tradicionales linternas de tormenta que empleaban tubos de vidrio para proteger la llama, *Flar* incluye una base de acero cortada con láser 3D y que se abre como una flor para dar paso a un difusor de vidrio soplado atractivamente imperfecto disponible en dos tamaños, 45 y 60 cm. *Flar* incorpora un regulador que se controla con el interruptor montado en el cable y permite a los usuarios modular la intensidad de la luz para crear su esquema de iluminación ideal. Los dos tamaños ofrecen la oportunidad de jugar con la escala para crear una composición única para el recibidor de un hotel o para una tienda. ● ES

Название *Flar* вызывает в воображении образы вспышки или французское слово «flamboiement», означающее интенсивное пламя или вспышку света. Вдохновленная традиционными штормовыми фонарями, в которых применяются стеклянные трубки для защиты пламени, лампа *Flar* имеет стальное основание 3D, вырезанное лазером, раскрывающееся подобно цветку, ведущее к очаровательно несовершенному диффузору из дутого стекла двух размеров: 45 и 60 см. *Flar* оборудована диммером, управляемым при помощи переключателя питания, монтированного на кабель, для модуляции интенсивности света, позволяя пользователям создавать идеальную схему освещения. Два размера предоставляют возможность играть с масштабом, чтобы создавать уникальные композиции для гостиничного холла или торгового помещения. ● RU

*Flar*这个名字让人联想到耀斑之像或法语的'flamboiement'一词—意为一股烈焰或一阵光耀。受到使用玻璃管保护火焰的传统防风灯的启发,*Flar*包含一个3D激光切割钢底座,它像花朵一样张开,形成一个优美迷人的不完美式吹制玻璃灯罩,提供45厘米和60厘米两种尺寸。*Flar*具有一个使用安装在线缆上的电源开关进行控制的调光器,使用户能够调节光线强度,以创建理想的照明方案。两种尺寸提供延展发挥的机会,可为酒店休息室或零售空间创建独特组合。● ZH

Visit website:



Flar medium ↘ Table lamp, Floor lamp **NEW LAMP**

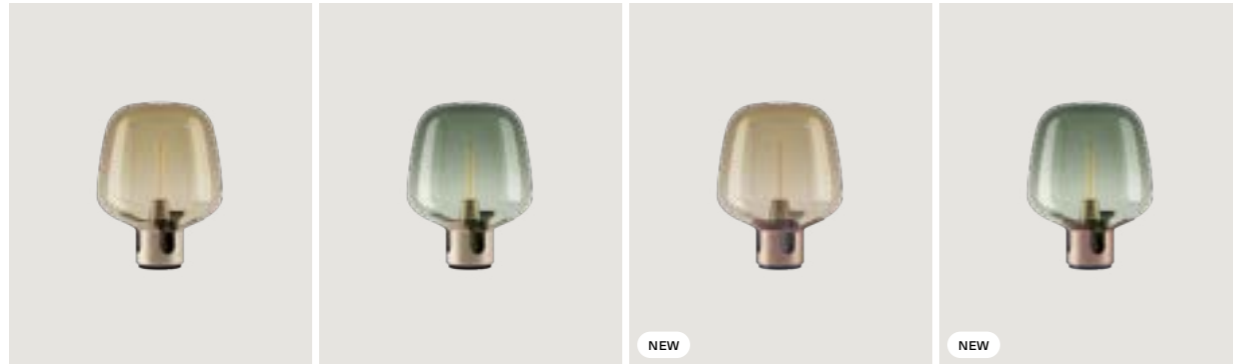

Flar large ↘ Table lamp, Floor lamp **NEW LAMP**

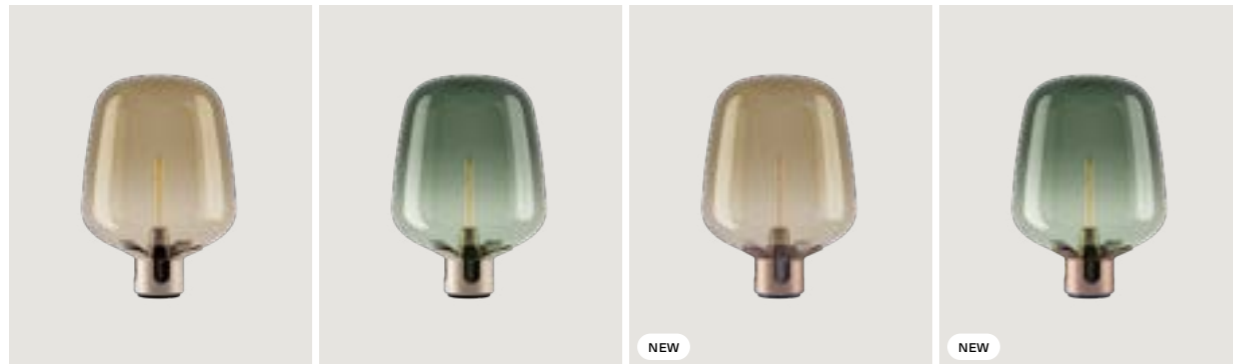

Flar, design by Patrick Norguet, 2022

Table lamp Floor lamp

Flar medium NEW

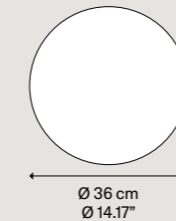
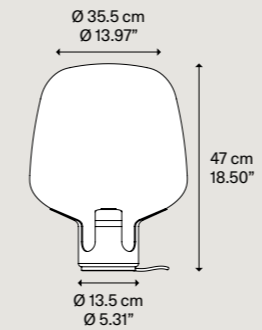

Net weight/ Peso netto: 6.1 kg

Pack/ Colli: 2

Light source
Sorgente luminosa

E27 T65
Tubular LED
↘ 1 × 25 W

Bulb not included
Lampadina non inclusa

Metal structure
Montatura in metallo

- Champagne Champagne
- Champagne Champagne
- Terra NEW Terra
- Terra NEW Terra

Blown glass diffuser
Diffusore in vetro soffiato

- Honey Miele
- Turquoise Turchese
- Honey Miele
- Turquoise Turchese

Code
Codice

- 19182 6800
- 19182 8600
- 19183 6800
- 19183 8600



Flar large NEW

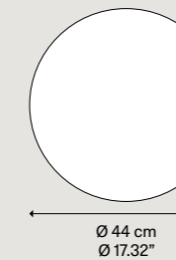
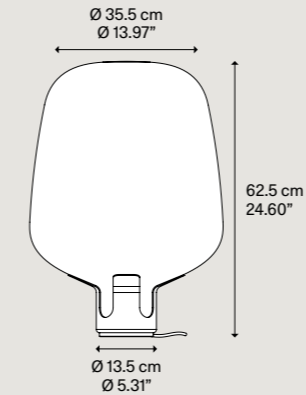

Net weight/ Peso netto: 8 kg

Pack/ Colli: 2

Light source
Sorgente luminosa

E27 T65
Tubular LED
↘ 1 × 25 W

Bulb not included
Lampadina non inclusa

Metal structure
Montatura in metallo

- Champagne Champagne
- Champagne Champagne
- Terra NEW Terra
- Terra NEW Terra

Blown glass diffuser
Diffusore in vetro soffiato

- Honey Miele
- Turquoise Turchese
- Honey Miele
- Turquoise Turchese

Code
Codice

- 19184 6800
- 19184 8600
- 19185 6800
- 19185 8600



Easy Peasy

With a strong personality and a sculptural form reminiscing the shape of bells, *Easy Peasy* is a set of portable and rechargeable table lamps, consisting of two rounded elements, a body and a knob. Made of blown glass, *Easy Peasy* allows for personal customisation of the living spaces. Its portability, different shapes and colours, and the *dim-to-warm* functionality of its light source allow users to connect, play and interact with the variable configuration options. It is not just a table lamp: it is a real character to interact with!

Con una spiccata personalità e una linea sculturale che ricorda la forma delle campane, *Easy Peasy* è un set di lampade da tavolo portatili e ricaricabili, composte da due elementi stoncati, un corpo e un pomolo. Realizzata in vetro soffiato, *Easy Peasy* permette la personalizzazione individuale degli spazi abitativi. La sua portabilità, le diverse forme e colori e la funzione *dim-to-warm* della sorgente luminosa a LED permettono agli utenti di interagire, giocare e dialogare con le differenti possibilità di configurazione della luce. Non è solo una lampada da tavolo: è un vero e proprio personaggio con cui interagire!

Cordless table lamp

Easy Peasy family,
Lagoon, Flamingo, Kelp and Chestnut

Easy Peasy, *design by* Luca Nichetto, 2020





Easy Peasy, knob, glass bell, diffuser

Easy Peasy,
Chestnut and Kelp



Easy Peasy,
Flamingo and Lagoon



Easy Peasy, Chestnut and Flamingo



Easy Peasy, turn on and off, dim light intensity and warmth



Easy Peasy, portable and rechargeable table lamp



Easy Peasy, micro USB socket

Avec sa forte personnalité et une ligne sculpturale qui rappelle la forme des cloches, *Easy Peasy* est un ensemble de lampes sur table portables et rechargeables, composé de deux éléments arrondis, un corps et un pommeau. Réalisée en verre soufflé, *Easy Peasy* permet la personnalisation individuelle des espaces de vie. Sa portabilité, ses différentes formes et couleurs et la fonction « *dim-to-warm* » de la source lumineuse à LED permettent aux utilisateurs d'interagir, de jouer et de dialoguer avec les différentes possibilités de configuration de la lumière. Ce n'est pas seulement une lampe de table : c'est un véritable personnage avec lequel on peut interagir ! ● FR

Mit einer besonderen Persönlichkeit und einer skulpturalen Linie, die an die Form einer Glocke erinnert, ist *Easy Peasy* ein Set aus mitnehmbaren und aufladbaren Tischleuchten, bestehend aus zwei abgerundeten Elementen, einem Korpus und einem Knauf. Aus geblasenem Glas hergestellt, ermöglicht *Easy Peasy* eine individuelle Personalisierung der Wohnräume. Die Mitnehmbarkeit, die verschiedenen Formen und Farben sowie die Funktion *Dim-to-warm* der LED-Lichtquelle ermöglichen den Nutzern mit den verschiedenen Konfigurationsmöglichkeiten für das Licht zu interagieren, zu spielen und in Dialog zu treten. Es ist nicht nur eine Tischlampe: Es ist eine echte Figur, mit der man interagieren kann. ● DE



Easy Peasy, packaging

Con una marcada personalidad y una línea escultural que recuerda la forma de las campanas, *Easy Peasy* es un set de lámparas de sobremesa portátiles y recargables, compuestas por dos elementos redondeados, un cuerpo y un pomo. Realizada en vidrio soplado, *Easy Peasy* permite la personalización individual de los espacios habitacionales. Su portabilidad, las diversas formas y colores y la función *dim-to-warm* de la fuente luminosa a LED permiten a los usuarios interactuar, jugar y dialogar con las diferentes posibilidades de configuración de la luz. No es sólo una lámpara de mesa: es un personaje real con el que interactuar. ● ES

Обладающие ярко выраженной индивидуальностью и скульптурным силуэтом, напоминающим форму колокола, светильники *Easy Peasy* – это серия портативных перезаряжаемых настольных ламп, состоящих из двух закругленных элементов, корпуса и ручки. Лампы *Easy Peasy*, изготовленные из выдувного стекла, придают оформлению жилого пространства самобытность и оригинальность. Портативность, разнообразие форм и цветов, а также функция *dim-to-warm* источника света LED позволяют пользователям взаимодействовать, фантазировать и применять возможности различных конфигураций освещения. Это не только настольный светильник – это настоящий персонаж с которым можно контактировать. ● RU

*Easy Peasy*具有强烈的个性和雕塑感，酷似铃铛的形状，它是一组便携式可充电台灯。由两个圆形元素组成，一个主体和一个圆头。台灯由吹制玻璃制成，*Easy Peasy* 可实现生活空间的个性化定制。它的便携性、不同的形状和颜色及其LED光源*dim-to-warm*的调光功能，允许用户与不同的灯光配置选项进行交互、游戏和对话。*Easy Peasy*不仅是盏台灯：它是一个具有个性能与空间互动的活泼伙伴 ● ZH

Visit website:



Easy Peasy, design by Luca Nichetto, 2020

Cordless table lamp

Easy Peasy

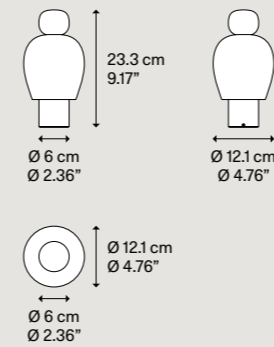

Net weight/Peso netto: 0.85 kg Pack/Coll: 1

Light source Sorgente luminosa	Technopolymer knob Pomolo in tecnopolimero	Blown glass shade Cappello in vetro soffiato	Metal base Base in metallo	Code Codice
-----------------------------------	---	---	-------------------------------	----------------

Flamingo

LED ↘ Dim-to-Warm from 2700 K to 3300 K ↘ 3 W/380 lm ↘ 2000 mA Battery ↘ CRI 90 ↘ MacAdam 3-Step	Pink Rosa	Grey Grigio	Brushed Bronze Spazzolato	17081 6226
---	--------------	----------------	---------------------------------	------------

LED and battery included
LED e batteria inclusi

Lagoon

LED ↘ Dim-to-Warm from 2700 K to 3300 K ↘ 3 W/380 lm ↘ 2000 mA Battery ↘ CRI 90 ↘ MacAdam 3-Step	Turquoise Turchese	Honey Miele	Brushed Gold Oro Spazzolato	17081 8126
---	-----------------------	----------------	--------------------------------------	------------

LED and battery included
LED e batteria inclusi



Easy Peasy

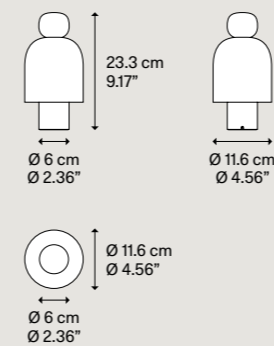

259 Spec sheet

Light source Sorgente luminosa	Technopolymer knob Pomolo in tecnopolimero	Blown glass shade Cappello in vetro soffiato	Metal base Base in metallo	Code Codice
-----------------------------------	---	---	-------------------------------	----------------

Kelp

LED ↘ Dim-to-Warm from 2700 K to 3300 K ↘ 3 W/380 lm ↘ 2000 mA Battery ↘ CRI 90 ↘ MacAdam 3-Step	Green Verde	Honey Miele	Brushed Rose Gold Oro Rosa Spazzolato	17081 7226
---	----------------	----------------	--	------------

LED and battery included
LED e batteria inclusi

Chestnut

LED ↘ Dim-to-Warm from 2700 K to 3300 K ↘ 3 W/380 lm ↘ 2000 mA Battery ↘ CRI 90 ↘ MacAdam 3-Step	Taupe Grigio Caldo	Grey Grigio	Brushed Palladium Spazzolato	17081 3826
---	-----------------------	----------------	------------------------------------	------------

LED and battery included
LED e batteria inclusi



Battery charging time Tempo di ricarica	Battery life Durata batteria
Power supply 1A ▶ 180 min	Full power (100%) ▶ 6h Half power (50%) ▶ 10h Minimum power (10%) ▶ 19h

Blow

As light as a breath, Blow is an ethereal and original table lamp. Made from blown glass, it contains a bright light that can be directed inside the diffuser to create ever-different beams. Perfect for reading or furnishing personal and intimate spaces.

Leggera come un respiro, Blow è una lampada da tavolo eterea e ingegnosa. Realizzata in vetro soffiato, contiene una luce vivace che si può orientare all'interno del diffusore per creare fasci luminosi ogni volta diversi. Ideale per leggere e per arredare spazi personali e intimi.

Table lamp

Blow,
FINISH Clear

Blow, *design by* Pio & Tito Toso, 2005



Légère comme un souffle, Blow est une lampe sur table éthérée et ingénieuse. Réalisée en verre soufflé, elle renferme une lumière vivace qui peut être orienté à l'intérieur du diffuseur pour créer des faisceaux de lumière tous différents. Idéale pour la lecture et pour décorer les espaces personnels et intimes. ● FR

So leicht wie der Atem ist Blow eine himmlische und erfinderische Tischlampe. Hergestellt aus mundgeblasenem Glas, enthält die Leuchte ein lebhaftes Licht, das innen im Diffusor ausgerichtet werden kann, um stets neue Lichtstreifen entstehen zu lassen. Ideal zum Lesen und zum Einrichten persönlicher und intimer Räume. ● DE

Ligera como un suspiro, Blow es una etérea e ingeniosa lámpara de sobremesa. Fabricada en vidrio soplado, contiene una luz brillante que puede orientarse dentro del difusor para crear diferentes haces de luz cada vez. Ideal para leer y para decorar espacios personales e íntimos. ● ES

Легкий как дыхание, Blow – это изящный и очень оригинальный настольный светильник. Этот светильник, изготовленный из выдувного стекла, включает в себе живой и динамичный свет, который можно ориентировать внутри диффузора для создания всякий раз других световых пучков. Идеально подходит для чтения и для оформления личных и интимных пространств. ● RU

轻如呼吸, Blow是一款灵动而巧妙的台灯。由吹制玻璃制成, 含有充满活力的光线, 可以将其定向到灯罩的内部, 每次发出不同的光束。阅读和布置个人和私密空间的理想之选。● ZH

Visit website:



Blow ▾ Table lamp



Blow, design by Pio & Tito Toso, 2005

Table lamp

Blow

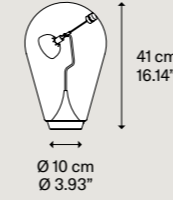

Light source Sorgente luminosa	Metal structure Montatura in metallo	Blown glass diffuser Diffusore in vetro soffiato	Code Codice
LED ▾ 2700 K ▾ 4.5 W / 500 lm ▾ 500 mA ▾ CRI 90 ▾ MacAdam 3-Step	Chrome Cromo	Clear Trasparente	00880 27

LED and driver included
LED e driver inclusi

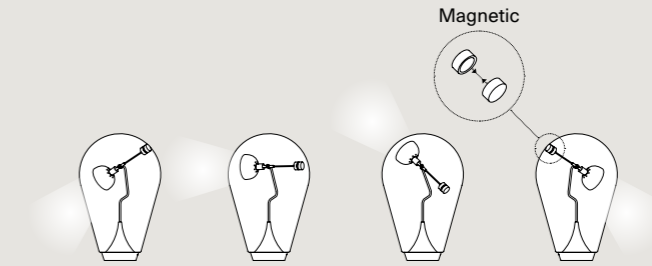

Adjustable light
Luce orientabile

Net weight / Peso netto: 4.00 kg

Pack / Colli: 1

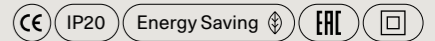

Croma

Taking its name from the Italian word for a 'quaver' or 'eighth', *Croma* reflects the dynamism of the musical note in its slender frame. It features a conical base that provides stability and a sleek body which casts a powerful ray of light from its LED source. A ring conveniently positioned halfway up the stem allows the user to control the LED module, and to utilise its *dim-to-warm* function. Its two unique metallic ombré colourways and the two texturised white and black finishes make *Croma* suitable for a variety of environments, including residential, hotel and hospitality.

La nuova lampada da terra richiama nel nome la "croma" o "ottavo": la sua struttura slanciata che proietta fasci di luce lungo la parete verso il soffitto evoca il dinamismo della nota musicale. Croma ha una base conica che le conferisce stabilità e una silhouette longilinea che proietta un potente raggio di luce dalla sorgente LED. Un anello posizionato a metà altezza dello stelo consente all'utente di regolare il modulo a LED e gestire la funzione *dim-to-warm*. Le due finiture metallizzate ombré, e le due tonalità testurizzate bianco e nero rendono *Croma* adatta a una varietà di ambienti, dal residenziale all'hotel e ospitalità.

Floor lamp

Croma, FINISHES Matte White and Matte Black

Croma, design by Luca Nichetto, 2021





Croma, turn on and off, dim light intensity and warmth

Croma, FINISH Green



Croma, Light source

Croma,
FINISHES Bronze and Green





Croma,
FINISH Matte Black



Croma, turn on and off, dim light intensity and warmth

Croma,
FINISH Bronze



Croma, Dim-to-warm *from 2200 to 3200 K*

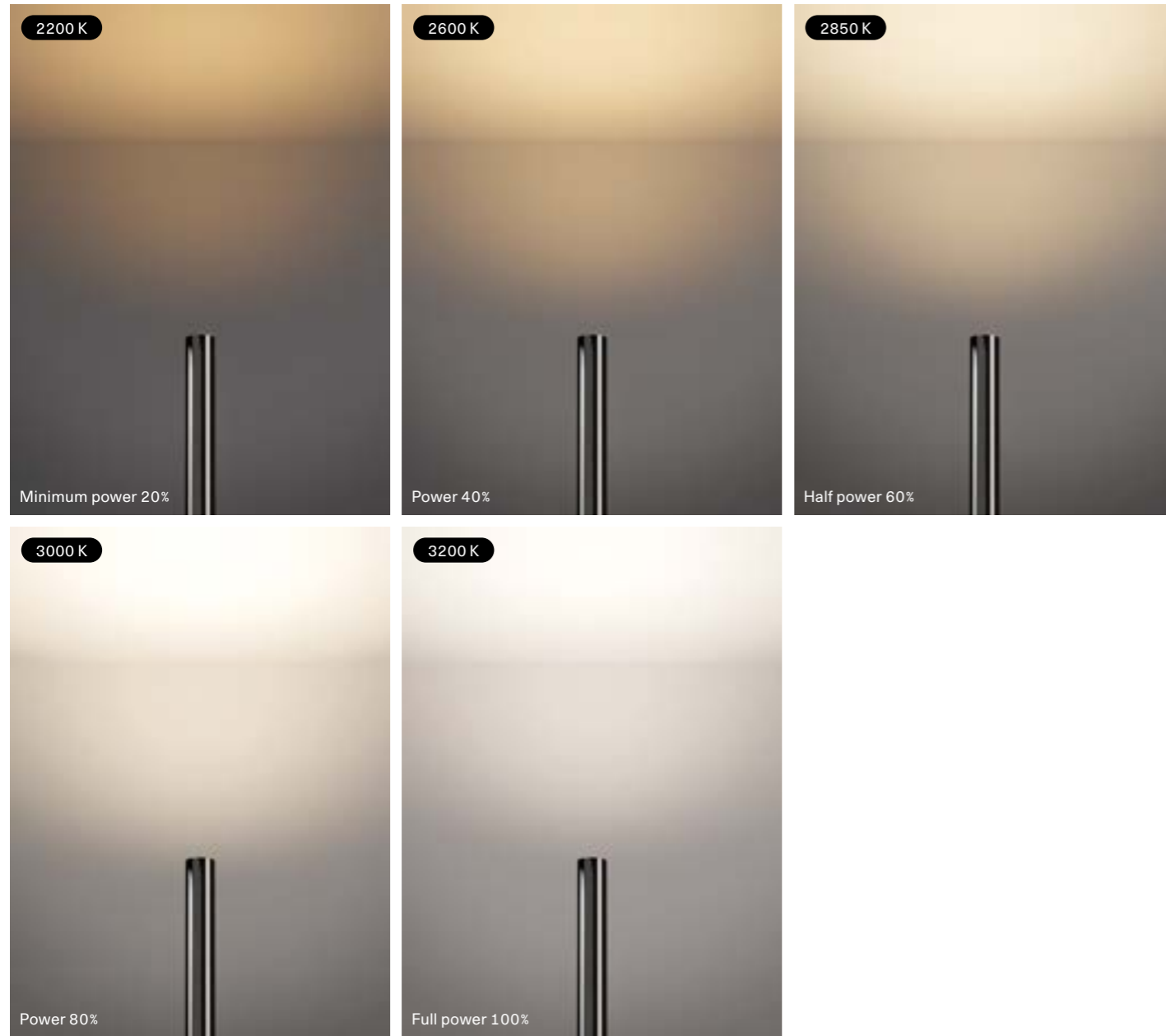

Croma, Dim-to-warm function

Le nouveau lampadaire prend son nom du mot italien désignant une *croche* ou une *hampe* : sa structure élancée dissipe les faisceaux de lumière vers le haut du mur et le plafond pour évoquer le dynamisme de la note de musique. *Croma* s'appuie sur une base conique qui assure sa stabilité et lui donne une allure longiligne qui projette un puissant rayon de lumière de la source LED. Un anneau placé à mi-hauteur de la hampe permet à l'utilisateur de contrôler le module LED et de gérer la fonction *dim-to-warm*. Grâce aux deux nouvelles finitions métallisées ombré et aux deux tonalités texturisées blanche et noire, *Croma* épouse toute une variété d'ambiances, du résidentiel à l'hôtellerie et à l'accueil. ●FR

Der Name der neuen Stehleuchte leitet sich vom italienischen Wort für "Achtelnote" oder "Achtel" ab: Ihre schlanke Struktur, die die Lichtstrahlen entlang der Wand in Richtung Decke projiziert, spiegelt die Dynamik der Musiknote wider. *Croma* hat einen konischen Sockel, der ihr Stabilität verleiht und eine langgestreckte Silhouette, die einen kraftvollen Lichtstrahl aus dem LED-Leuchtmittel abgibt. Ein auf halber Höhe des Ständers angebrachter Ring ermöglicht dem Benutzer, das LED-Modul zu steuern und die *Dim-to-Warm-Funktion* zu nutzen. Metallische Ombré Ausführungen und zwei strukturierte Schwarz- und Weißtöne ermöglichen den Einsatz von *Croma* in einer Vielzahl von Umgebungen, vom Wohnbereich bis hin zu Hotels und Hospitality. ●DE

La nueva lámpara de pie evoca en el nombre la *corchea* o *octava*: su estructura estilizada que proyecta haces de luz en la pared hacia el techo evoca el dinamismo de la nota musical. *Croma* descansa sobre una base cónica queda estabilidad a su silueta alargada que proyecta un potente rayo de luz de la fuente LED. Un anillo situado a media altura del pie le permite al usuario regular el módulo LED y controlar la función *dim-to-warm*. Los dos nuevos acabados metalizados ombré y los dos colores texturizados blanco y negro hacen que *Croma* sea apropiada para distintos ambientes, del residencial pasando por el hotelero a la hostelería. ●ES

Новый торшер напоминает своим названием итальянское слово «сромта» или «восьмой»: его утонченная структура, проецирующая лучи света вдоль стены к потолку, ассоциируется с динамизмом музыкальной ноты. *Croma* имеет коническое основание, которое придает лампе устойчивость и утонченность силуэта. Лампа проецирует мощный луч света от светодиодного источника. Кольцо, расположенное на середине ноги торшера, позволяет пользователю регулировать светодиодный модуль и управлять функцией *dim-to-warm*. Две новые металлизированные отделки деграде и две новые текстурированные тональности черного и белого делают лампу *Croma* подходящей для самых разных применений, от жилых помещений до отелей и структур по приему гостей. ●RU

新款落地灯呼应“颤音”或“八分音符”之名:纤细修长的结构沿着墙壁向天花板散射光束,唤起音符之活力。Croma有一个锥形底座上,该底座为其赋予稳定性以及一个可从LED光源投射出强烈光线的纤长轮廓。一只位于灯茎一半处的圆环使用户能够调整LED模块并管理从暗到暖的调光功能。两种金属渐变效果饰面以及纯白色和黑色两种纹理色调,使Croma适用于包括住宅、酒店及招待场所在内的各类环境。●ZH

Visit website:



Croma, design by Luca Nichetto, 2021

Floor lamp

Croma NEW

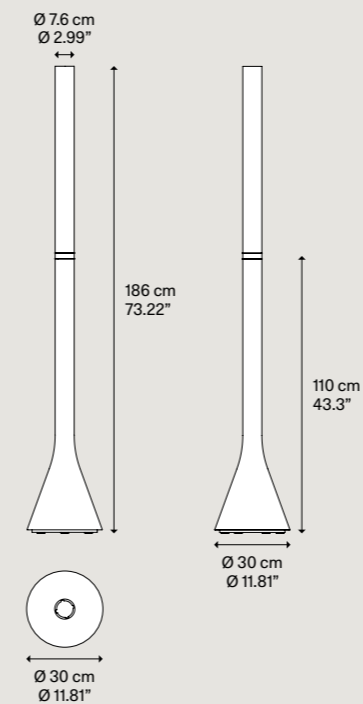

Net weight/Peso netto: 15 kg Pack/Colli: 1

Light source Sorgente luminosa

LED
 ↳ Dim-to-warm from **2200 K** to **3200 K**
 ↳ 42 W/5600 lm
 ↳ 220-240 V
 ↳ CRI 90
 ↳ MacAdam 3-Step

Metal structure Montatura in metallo

● Matte White – 9010
 Bianco Opaco – 9010
 ● Matte Black – 9005
 Nero Opaco – 9005
 ● Bronze
 Bronzo
 ● Green
 Verde

Code Codice

17270 1000
 17270 2000
 17270 3400
 17270 7000

Dim-to-warm

▶ 20%	2200 K	1400 lm
▶ 40%	2600 K	2400 lm
▶ 60%	2850 K	3550 lm
▶ 80%	3000 K	4600 lm
▶ 100%	3200 K	5600 lm

LED included
 LED incluso



Croma ↳ Floor lamp **NEW LAMP**



Cima

Inspired by the function of the jam cleats found in sailing boats, Cima – a nautical rope in Italian – is a “suspended” lamp characterised by a ceiling-to-floor rope, a sleek and highly functional design element. A joint that holds the lamp body slides vertically along the rope, while the counterweight allows to manage any excess rope. The simple cylindrical shapes and the black colour of these elements highlight the three brilliant finishes of the rope, vibrant accents to suit any interiors and décor mood.

Ispirata dalla funzione degli strozzascotte delle barche a vela, Cima è una lampada “sospesa” caratterizzata da una fune a tutt’altezza, elemento di design elegante e altamente funzionale. Lungo la fune scorre verticalmente un giunto che regge il corpo lampada, mentre il contrappeso permette di gestire l’eventuale fune in eccesso. Le semplici forme cilindriche e il colore nero di questi elementi risaltano le tre finiture brillanti della fune, accenti vibranti per qualsiasi ambiente e mood d’arredo.

Suspension lamp, Floor lamp

Cima,
FINISHES Yellow, Silver and Gold

Cima, *design by* Marco Dessí, 2021





Cima, FINISH Gold



Cima, FINISH Silver



1



2

1–Cima, FINISH Silver, set the rope at the desired length

2–Cima, FINISH Silver, counterweight / switch button on the power cord



Cima, FINISH Yellow



Cima, FINISH Silver



Cima, easy personalisation of light:
1-Change the angle of the lamp body

2-Adjust the height of the joint

S'inspirant de la fonction des taquets de blocage des voiliers, Cima – une corde nautique en italien – est une lampe « suspendue » caractérisée par une corde plafond-sol, élément de design élégant et fonctionnel. Le raccord qui supporte le corps de la lampe se déplace le long de la corde, tandis que le contrepoids permet d'ajuster l'excès de corde. Les formes cylindriques simples et la couleur noire de ces éléments mettent en valeur les trois finitions brillantes de la corde pour s'adapter à tous les intérieurs et à tous les styles de décoration. ● FR

Inspiriert von der Funktion der Klampen, die in Segelbooten zu finden sind, ist Cima – das bedeutet Schiffsseil auf Italienisch – eine „hängende Leuchte“, die sich durch ein Decken-Boden-Seil auszeichnet, ein elegantes und hoch funktionales Designelement. Entlang des Seils bewegt sich ein Gelenk, das den Lampenkörper stützt, während das Gegengewicht es ermöglicht, einen eventuellen Seilüberschuss zu justieren. Die schlichten Formen und die schwarze Farbe dieser Elemente unterstreichen die drei brillanten Ausführungen des Seils, vibrierende Akzente, die für jedes Interieur und jede Dekor Stimmung geeignet sind. ● DE

Inspirada en la función de las cornamusas que se encuentran en los veleros, Cima – una cuerda náutica en italiano – es una lámpara “suspendida” caracterizada por una cuerda que va del techo al suelo, un elemento de diseño elegante y sumamente funcional. A lo largo de la cuerda se mueve verticalmente una articulación que sujeta el cuerpo de la lámpara, mientras que el contrapeso permite reajustar cualquier exceso de cuerda. Las sencillas formas cilíndricas y el color negro de estos elementos resaltan los tres acabados brillantes de la cuerda, las notas vibrantes de cualquier interior y decoración de ambiente. ● ES

Вдохновленный функцией палубных стопоров, используемых на парусных лодках, светильник Cima – «корабельный канат» на итальянском – представляет собой подвешенную лампу, с тросом в полную высоту, задуманным как изысканный и высоко функциональный элемент дизайна. Вдоль троса вертикально перемещается шарнир, поддерживающий корпус лампы, а противовес позволяет отрегулировать избыток троса. Простые цилиндрические формы и черный цвет этих элементов подчеркивают три яркие отделки троса, вибрирующие тональности, подходящие для любых интерьеров и стилей. ● RU

受帆船中防滑钉的功能之启发,Cima—意大利语意为航海绳—是一款特征显著的“悬浮灯”,一条全高式绳索便是其优雅且功能强大的设计元素。一块用来举持灯体的接头沿绳索垂直延伸,而配重件则可让您调节管理绳索的任何多余之处。这些元素的简约圆柱形状与黑色突出了绳索的三种光鲜饰面,令任何室内环境与装饰风尚活力四射。● ZH

Visit website:



Cima ▾ Suspension lamp, Floor lamp

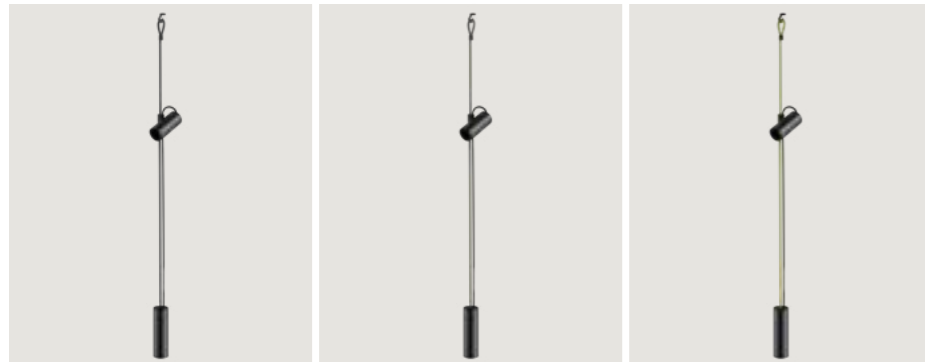

Finishes ▾ Rope

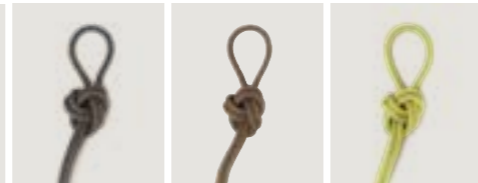

Cima, design by Marco Dessí, 2021

Suspension lamp

Floor lamp

Cima

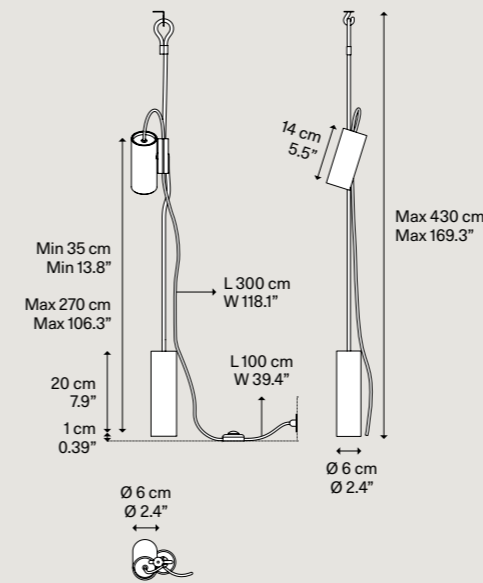

Light source Sorgente luminosa	Metal structure Montatura in metallo	Rope Corda	Code Codice
GU10 Par 16 LED ≈ 1 × 10 W II	Matte Black Nero Opaco	Silver Argento	17371 4100
W/L max 9 cm W/L max 3.54"		Gold Oro	17371 5000
Bulb not included Lampadina non inclusa		Yellow Giallo	17371 5100
Light source Sorgente luminosa	Description Descrizione	Metal structure Montatura in metallo	Code Codice
GU10 Par 16 LED ≈ 1 × 10 W II	Additional kit Kit aggiuntivo	Matte Black Nero Opaco	17371K 2000
W/L max 9 cm W/L max 3.54"			
Bulb not included Lampadina non inclusa			

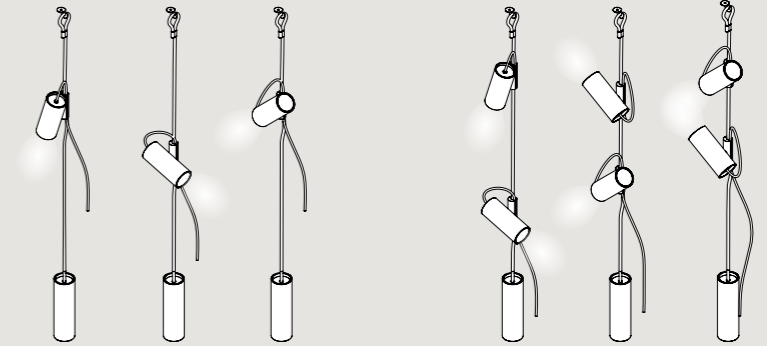

Adjustable light
Luce orientabile

Net weight / Peso netto: 1.750 kg

Pack / Colli: 1



Nautilus, Nautilus Mini

Strong design and leading-edge technology come together in this family of lamps characterised by a convex lens that projects the LED light wherever its needed or most preferred, for a truly efficient and personalised result. Versatile and dynamic, either on the wall or ceiling in a variety of versions and finishes, Nautilus lamps satisfy a full range of lighting needs, whether functional or purely decorative, in both residential and professional contexts.

Design deciso e tecnologia di punta si fondono in questa famiglia di lampade caratterizzate da una lente convessa che proietta la luce a LED dove serve o dove piace di più, per un risultato di efficienza e personalizzazione. Versatili e dinamiche, a parete o a soffitto, in diverse versioni e finiture, le lampade Nautilus soddisfano innumerevoli esigenze di illuminazione, dalle più funzionali a quelle particolarmente decorative, sia in ambito residenziale che professionale.

Wall lamp, Ceiling lamp

Nautilus and Nautilus Spot,
FINISH Chrome

Nautilus, *design by* Andrea Tosetto, 2017/2020





Nautilus and Nautilus Spot,
FINISH Matte Champagne



Nautilus, FINISH Matte White

1, 2



3, 4



1/4–Nautilus,
FINISHES Chrome, Matte Champagne,
Matte Black and Matte White

Nautilus,
FINISH Matte White

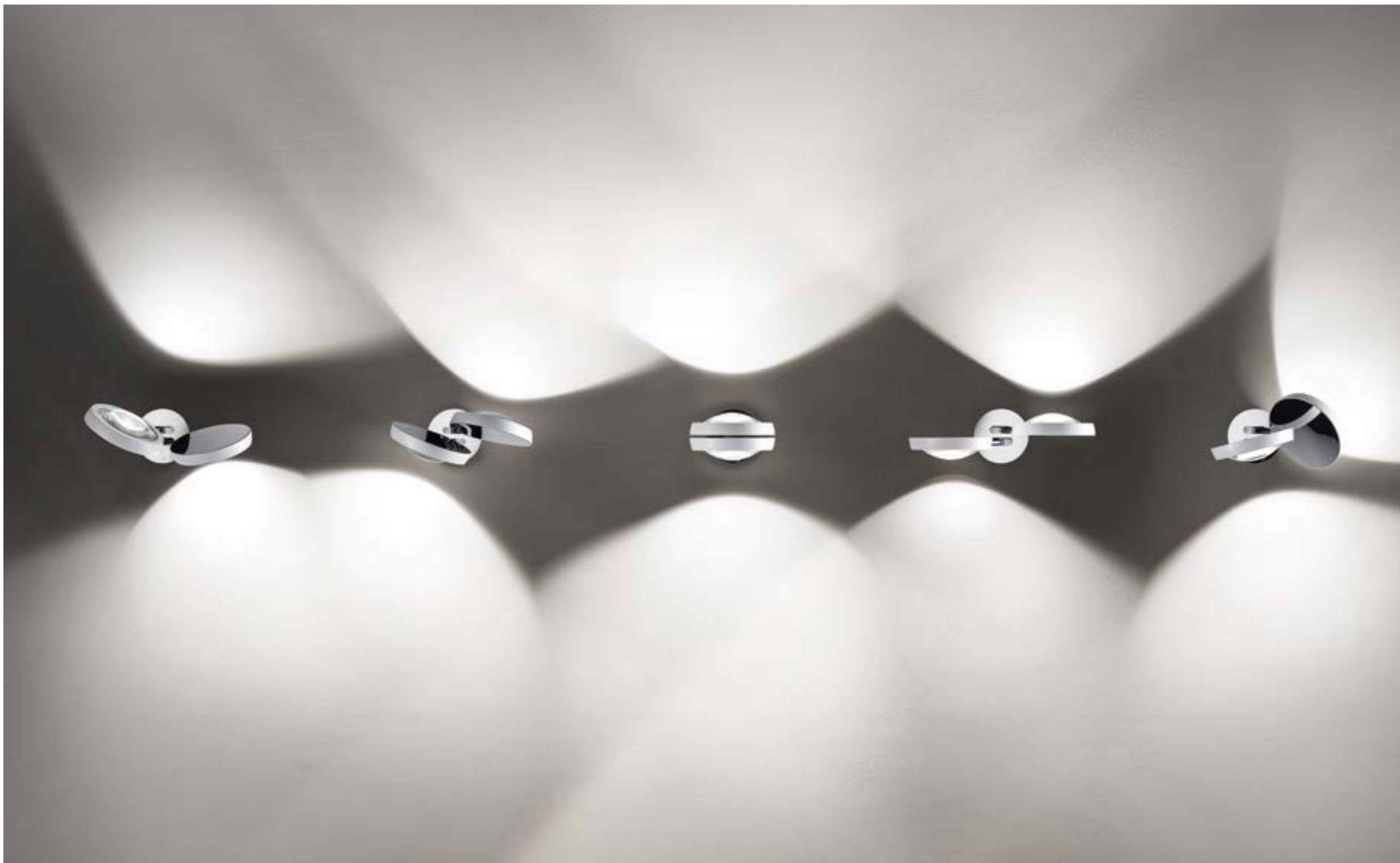

1–Nautilus,
FINISH Matte White

2–Nautilus,
FINISH Matte Black



Nautilus Spot, FINISHES Matte Champagne, Chrome and Matte Black

Nautilus and Nautilus Spot,
FINISH Matte Black





Nautilus Mini, FINISH Matte Champagne

1



2



3



1/3–Nautilus Mini, FINISH Matte White,
Matte Black and Matte Champagne



Nautilus, FINISH Matte White

Un design impeccable et une technologie de pointe fusionnent pour cette famille de lampes caractérisées par un verre convexe qui dirige la lumière à LED où il le faut et où vous le souhaitez le plus, pour un résultat efficace et personnalisé. Polyvalentes et dynamiques, appliques ou plafonniers, en différentes versions et finitions, les lampes Nautilus répondent à d'innombrables besoins d'éclairage, des plus fonctionnels à ceux particulièrement décoratifs, aussi bien dans le domaine résidentiel que professionnel. ●FR

Entschlossenes Design und Spitzentechnologie verschmelzen in dieser Leuchtenfamilie miteinander. Dabei ist letztere durch eine konvexe Linse gekennzeichnet, die LED-Licht dorthin strahlt, wo es notwendig ist oder am besten gefällt. So entsteht ein effizientes, personalisiertes Ergebnis. Vielseitig und dynamisch entsprechen die Wand- oder Deckenleuchten Nautilus in verschiedenen Versionen und Ausführungen zahlreichen Bedürfnissen betreffend die Beleuchtung nach - von besonders funktionell bis hin zu besonders dekorativ, sowohl im Wohnbereich wie auch im beruflichen Umfeld. ●DE

El diseño decisivo y la tecnología de vanguardia se unen en esta familia de lámparas caracterizada por una lente convexa que proyecta la luz LED donde se necesita o donde más gusta, para un resultado de eficiencia y personalización. Versátiles y dinámicas, de pared o de techo, en diferentes versiones y acabados, las lámparas Nautilus satisfacen innumerables necesidades de iluminación, desde las más funcionales hasta las más decorativas, tanto en entornos residenciales como profesionales. ●ES

Чистый дизайн и передовые технологии сочетаются в этом семействе светильников, характеризующихся выпуклой линзой, которая проецирует свет лампы LED туда, где это необходимо или где вам больше нравится, обеспечивая эффективность и персонализацию. Светильники Nautilus, универсальные и динамичные, настенные или потолочные, в разных вариантах исполнения и отделки, удовлетворяют бесчисленные потребности светового оформления, от самого функционального до особо декоративного, как в жилых, так и в офисных помещениях. ●RU

决定性的设计与最先进的技术相结合，凸透镜是该家族系列灯具的特征，该凸透镜可将LED光投射到需要的地方或是您最喜欢的地方，以提高效率和定制化。Nautilus灯具有多功能性和动态性，可以壁式安装或吸顶安装，具有不同的版本和颜色，可以满足无数的照明需求，从最实用的功能到特别装饰性的功能，无论是在住宅还是在专业环境中。●ZH

Visit website:



Nautilus » Wall lamp



Nautilus Mini » Wall lamp

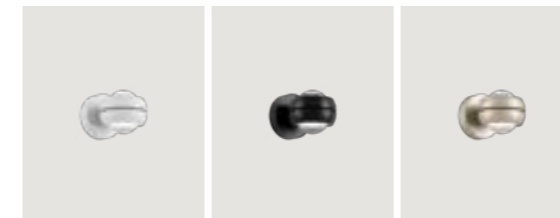

Nautilus » Ceiling lamp

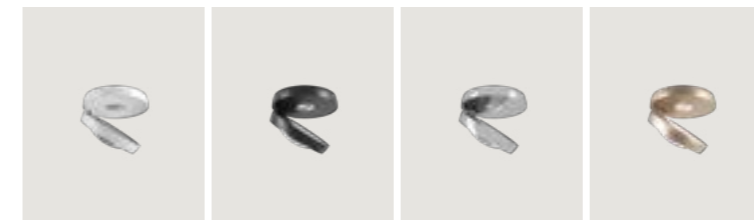

Nautilus Spot » Ceiling lamp



Nautilus, design by Andrea Tosetto, 2017

Wall lamp

Nautilus

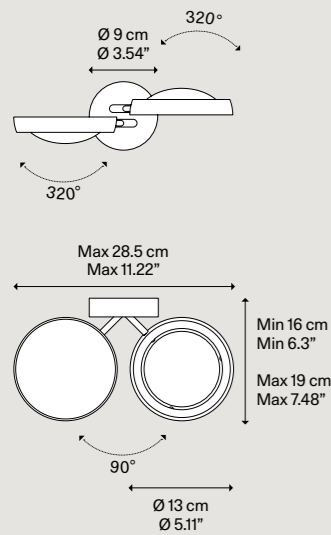

Light source Sorgente luminosa	Metal structure Montatura in metallo	Metal diffuser Diffusore in metallo	Code Codice
LED ↘ 2700 K ↘ 2 × 12 W/1990 lm ↘ 220-240 V ↘ CRI 90 ↘ MacAdam 3-Step	Matte White - 9010 Bianco Opaco - 9010	Matte White - 9010 Bianco Opaco - 9010	16550 1927
	Matte Black - 9005 Nero Opaco - 9005	Matte Black - 9005 Nero Opaco - 9005	16550 2927
	Chrome Cromo	Chrome Cromo	16550 4027
or	Matte Champagne Champagne Opaco	Matte Champagne Champagne Opaco	16550 4927
	Matte White - 9010 Bianco Opaco - 9010	Matte White - 9010 Bianco Opaco - 9010	16550 1930
	Matte Black - 9005 Nero Opaco - 9005	Matte Black - 9005 Nero Opaco - 9005	16550 2930
LED ↘ 3000 K ↘ 2 × 12 W/2170 lm ↘ 220-240 V ↘ CRI 90 ↘ MacAdam 3-Step	Chrome Cromo	Chrome Cromo	16550 4030
	Matte Champagne Champagne Opaco	Matte Champagne Champagne Opaco	16550 4930
	LED included LED incluso		



Adjustable light
Luce orientabile

Net weight/Peso netto: 1.15 kg Pack/Colli: 1

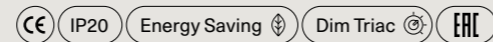

Wall lamp

Nautilus Mini

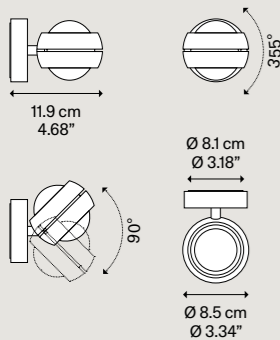

Light source Sorgente luminosa	Metal structure Montatura in metallo	Code Codice
LED ↘ 2700 K ↘ 2 × 6 W/950 lm ↘ 220-240 V ↘ CRI 90 ↘ MacAdam 3-Step	Matte White - 9010 Bianco Opaco - 9010	16551 1027
	Matte Black - 9005 Nero Opaco - 9005	16551 2027
	Matte Champagne Champagne Opaco	16551 4527
or	Matte White - 9010 Bianco Opaco - 9010	16551 1030
	Matte Black - 9005 Nero Opaco - 9005	16551 2030
	Matte Champagne Champagne Opaco	16551 4530
LED included LED incluso		



Adjustable light
Luce orientabile

Net weight/Peso netto: 0.75 kg Pack/Colli: 1

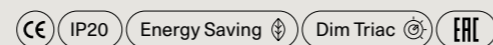

LED sources with direct power supply to the AC line voltage - driver not required. Dimmable with phase cut dimmer.

LED con alimentazione diretta a tensione di rete - non necessita di driver. Dimmerabile con varialuce a taglio di fase.

Nautilus, design by Andrea Tosetto, 2017

Ceiling lamp

Nautilus

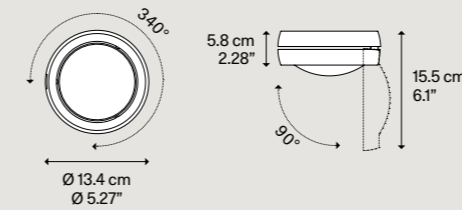

Light source Sorgente luminosa	Metal structure Montatura in metallo	Code Codice
LED ↘ 2700 K ↘ 12 W/995 lm ↘ 220-240 V ↘ CRI 90 ↘ MacAdam 3-Step	Matte White - 9010 Bianco Opaco - 9010	16530 1027
	Matte Black - 9005 Nero Opaco - 9005	16530 2027
	Chrome Cromo	16530 4027
LED included LED incluso	Matte Champagne Champagne Opaco	16530 4527
	Matte White - 9010 Bianco Opaco - 9010	16530 1030
	Matte Black - 9005 Nero Opaco - 9005	16530 2030
LED ↘ 3000 K ↘ 12 W/1085 lm ↘ 220-240 V ↘ CRI 90 ↘ MacAdam 3-Step	Chrome Cromo	16530 4030
	Matte Champagne Champagne Opaco	16530 4530
	LED included LED incluso	



Adjustable light
Luce orientabile

Net weight/Peso netto: 1.10 kg Pack/Colli: 1

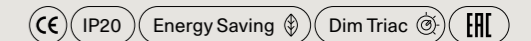

Nautilus Spot, design by Andrea Tosetto, 2020

Ceiling lamp

Nautilus Spot

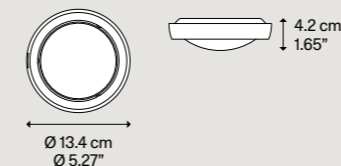

Light source Sorgente luminosa	Metal structure Montatura in metallo	Code Codice
LED ↘ 2700 K ↘ 10 W/945 lm ↘ 220-240 V ↘ CRI 90 ↘ MacAdam 3-Step	Matte White - 9010 Bianco Opaco - 9010	16560 1027
	Matte Black - 9005 Nero Opaco - 9005	16560 2027
	Chrome Cromo	16560 4027
LED included LED incluso	Matte Champagne Champagne Opaco	16560 4527
	Matte White - 9010 Bianco Opaco - 9010	16560 1030
	Matte Black - 9005 Nero Opaco - 9005	16560 2030
LED ↘ 3000 K ↘ 10 W/950 lm ↘ 220-240 V ↘ CRI 90 ↘ MacAdam 3-Step	Chrome Cromo	16560 4030
	Matte Champagne Champagne Opaco	16560 4530
	LED included LED incluso	

Net weight/Peso netto: 0.56 kg Pack/Colli: 1

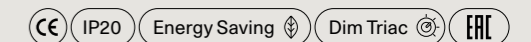

LED sources with direct power supply to the AC line voltage - driver not required. Dimmable with phase cut dimmer.

LED con alimentazione diretta a tensione di rete - non necessita di driver. Dimmerabile con varialuce a taglio di fase.

Aile

The new Aile aluminium wall lamp features a simple and dynamic design reminiscing the *aileron* of sport cars, after which it has been named. Aile's compact size, sleek design, powerful light output with respect to its dimensions and four rich finishes offer a complete lighting solution even for more intimate settings.

Aile, nuova lampada da parete in alluminio, presenta un design semplice e dinamico, proprio come l'alettone delle auto sportive, *aileron* in inglese, da cui prende il nome. La compattezza, il design elegante, la forte capacità di emissione di luce rispetto alle dimensioni e le quattro ricche finiture rendono Aile una soluzione perfetta anche per illuminare ambienti raccolti.

Wall lamp

Aile, design by Luca Nichetto, 2021



Aile, FINISH Lacquer Red



Aile, FINISH Lacquer Red



1–Aile, FINISH Lacquer Red
2–Aile, FINISH Matte Black



Aile, FINISH Matte White

Aile, FINISH Champagne

Légère applique en aluminium, la nouvelle Aile présente un design simple et dynamique rappelant l'aileron d'une voiture de sport dont le nom s'inspire. La taille compacte d'Aile, son design élégant, son rayonnement lumineux puissant par rapport aux dimensions et ses quatre riches finitions offrent une solution d'éclairage complète, même pour des espaces plus intimes. ●FR

Die neue Aile Aluminium-Wandleuchte zeichnet sich durch ein schlichtes Design mit einer dynamischen Form aus, die an das Querruder eines Sportwagens erinnert –aileron auf Englisch, nach dem sie benannt wurde. Ailes kompakte Größe, das schlanke Design und die starke Lichtleistung im Vergleich zur Fläche bieten eine komplette Beleuchtungslösung sogar für intimere Umgebungen. ●DE

Ligera lámpara de pared en aluminio, la nueva Aile presenta un diseño sencillo y dinámico que recuerda el alerón de un automóvil deportivo, aileron en inglés, que a su vez le da nombre. El tamaño compacto, el diseño elegante, la potente salida de luz con respecto a sus dimensiones y los cuatro ricos acabados hacen que Aile sea una solución de iluminación completa incluso para entornos más íntimos. ●ES

Новая настенная алюминиевая лампа Aile отличается простым дизайном и динамичной формой, напоминающей элероны спортивных автомобилей, «aileron» на английском, в честь которых она и получила свое название. Компактный размер, элегантный дизайн, мощная светоотдача, по сравнению с ее размерами, а также четыре варианта богатой отделки делают из Aile идеальное решение также для освещения более интимных уголков. ●RU

全新Aile铝制壁灯拥有简约大方且与动感十足的设计,令人联想到跑车的副翼,从而以此得名。Aile紧凑的尺寸、时尚的设计、相对其尺寸的强大光线输出以及四款丰富的饰面,为更多甚至私密的环境设置提供了一项完整的照明解决方案。●ZH

Visit website:



Aile, design by Luca Nichetto, 2021

Wall lamp

Aile

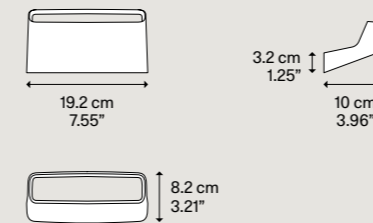

Light source Sorgente luminosa

LED
 ↘ 2700 K
 ↘ 2 × 8 W/1840 lm
 ↘ 220-240 V
 ↘ CRI 92
 ↘ MacAdam 3-Step

or

LED
 ↘ 3000 K
 ↘ 2 × 8 W/1960 lm
 ↘ 220-240 V
 ↘ CRI 92
 ↘ MacAdam 3-Step

LED included
 LED incluso

Metal structure Montatura in metallo

● Matte White – 9010
 Bianco Opaco – 9010

● Matte Black – 9005
 Nero Opaco – 9005

● Champagne
 Champagne

● Lacquer Red
 Rosso Lacca

● Matte White – 9010
 Bianco Opaco – 9010

● Matte Black – 9005
 Nero Opaco – 9005

● Champagne
 Champagne

● Lacquer Red
 Rosso Lacca

Code
Codice

17550 1027

17550 2027

17550 4527

17550 6027

17550 1030

17550 2030

17550 4530

17550 6030

Net weight/Peso netto: 0.55 kg

Pack/Coll: 1

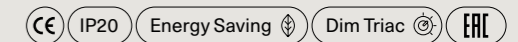

Aile ▾ Wall lamp

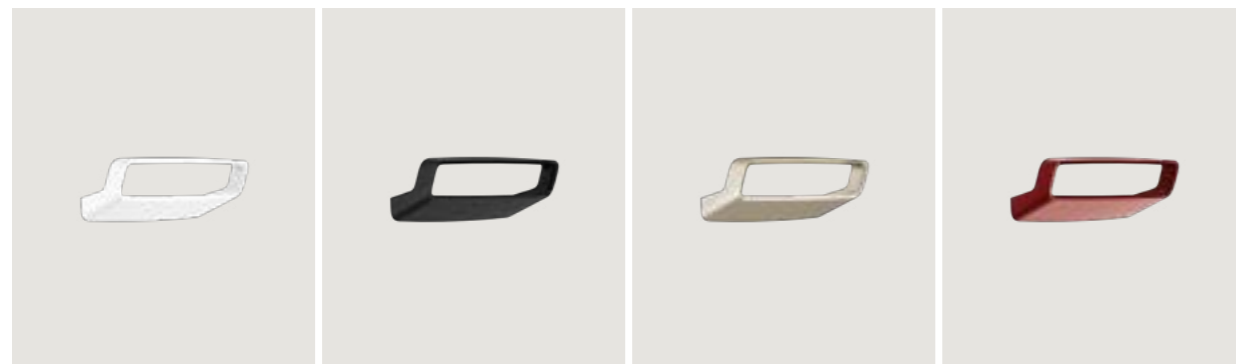

Puzzle Mega

Large geometric figures characterised by essential forms, which almost merge with the interior architecture when off, only to be surprisingly revealed as harmonies of light and shadow when lit. New matte finishes warm up the geometric panels of Puzzle Mega. Liquid paints that open new decorative possibilities, playing with harmonies and contrasts of colours and shapes.

Grandi figure geometriche dalle forme essenziali che quasi si fondono con l'architettura interna quando sono spente, per rivelare inaspettate armonie di luci e ombre una volta accese. Nuove finiture opache scaldano i pannelli geometrici di Puzzle Mega. Vernici liquide che aprono nuove possibilità decorative giocando con armonie e contrasti di colori e forme.

Wall lamp, Ceiling lamp

Puzzle Mega, FINISHES Matte
Red, Black and Taupe

Puzzle Mega, *design by* Studio Italia Design, 2019



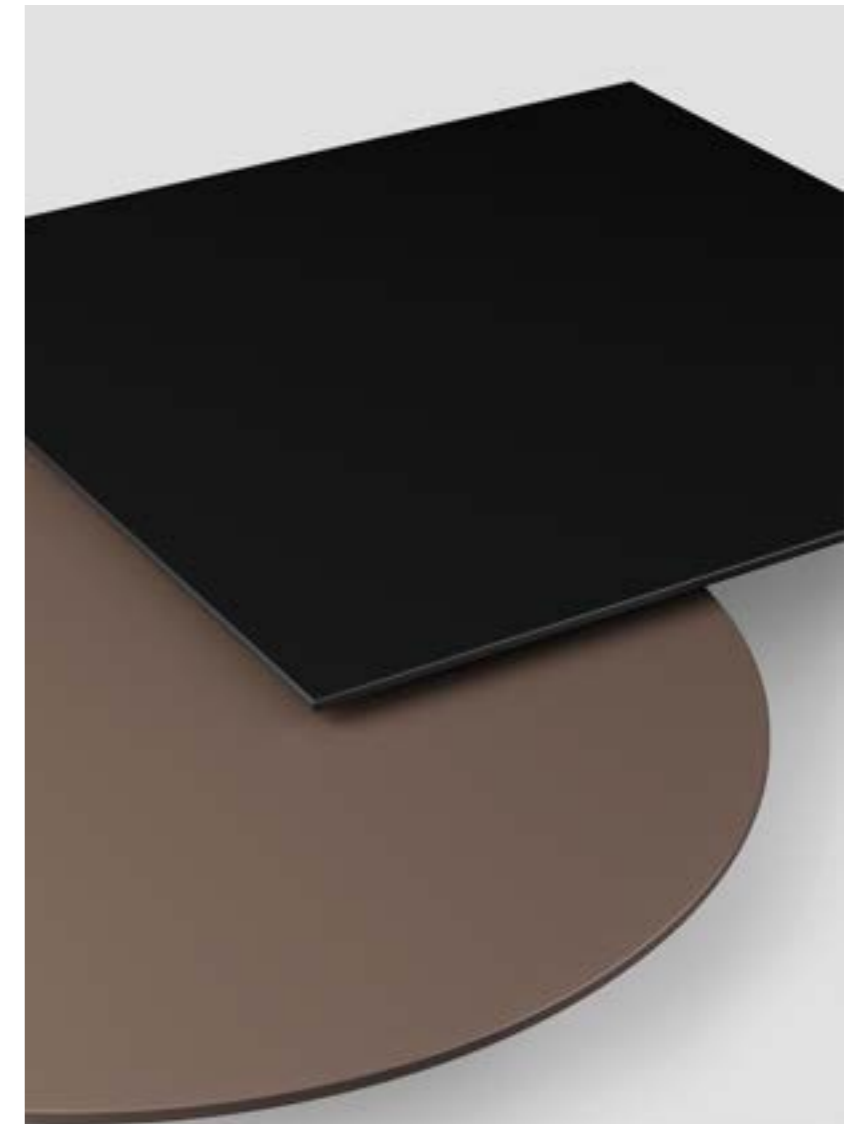

Puzzle Mega, FINISHES Matte Black and Taupe

Puzzle Mega, FINISHES Matte White, Taupe and Black

Puzzle Mega square large and round large,
FINISHES Matte Black and White



Puzzle Mega, FINISHES Matte White and Taupe



Puzzle Mega, FINISH Matte Red

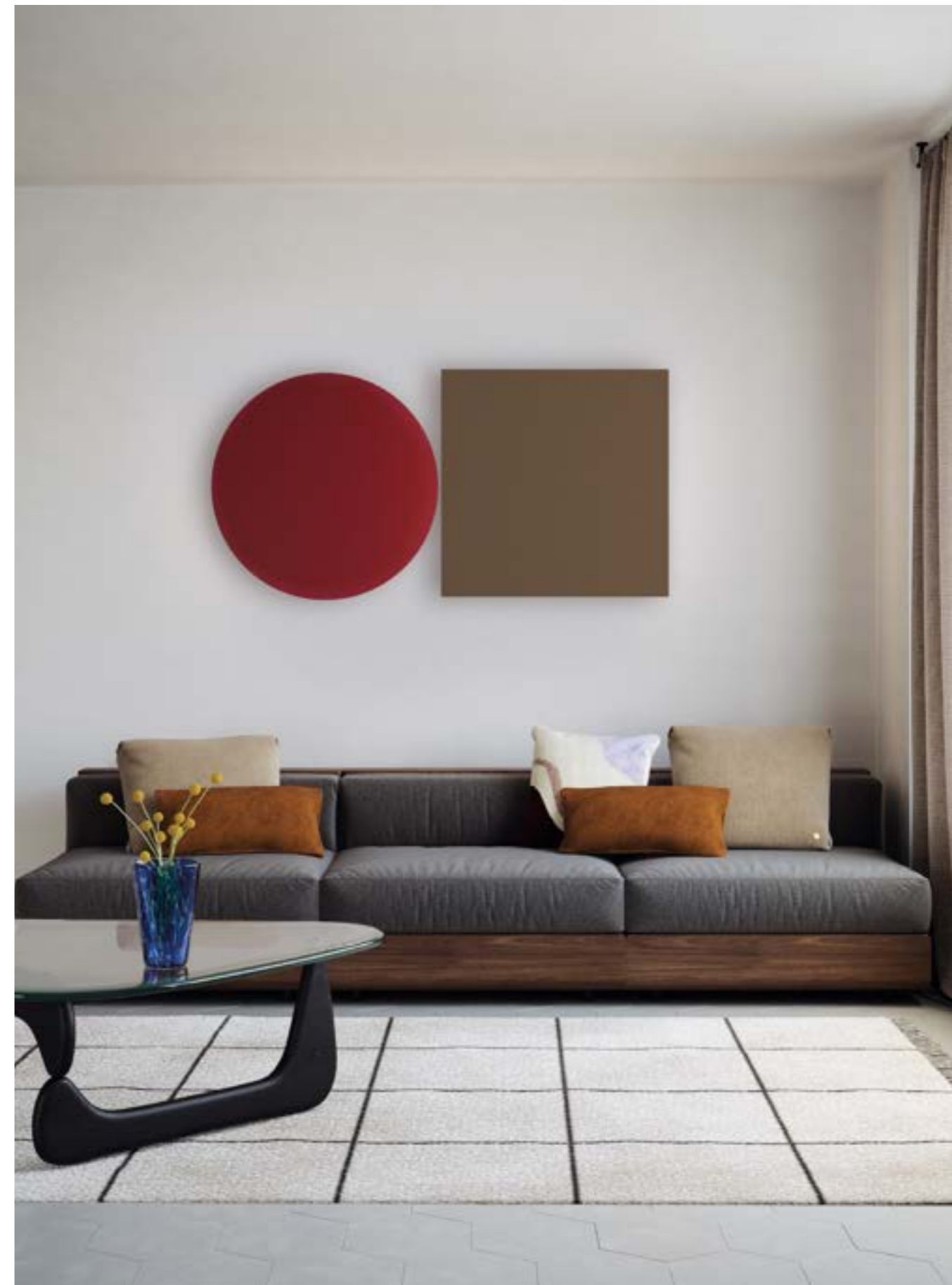

Puzzle Mega round large and square large, FINISHES Matte Red and Taupe



Puzzle Mega compositions, FINISHES Matte White and Taupe

Grandes figures géométriques aux formes essentielles qui se fondent presque dans l'architecture interne lorsqu'elles sont éteintes, pour révéler d'inattendues harmonies de lumière et d'ombres une fois éclairées. Les nouvelles finitions mates rendent les panneaux géométriques de Puzzle Mega plus chaleureux. Vernis liquides qui offrent de nouvelles possibilités décoratives en jouant avec les harmonies et les contrastes de couleurs et de formes. ● FR

Große geometrische Figuren in einfacher Form, die ausgeschaltet mit der Innenarchitektur verschmelzen, um eingeschaltet eine unerwartete Harmonie aus Licht und Schatten entstehen zu lassen. Neue matte Ausführungen erwärmen die geometrischen Paneele von Puzzle Mega. Flüssiglacke, die durch das Spiel mit Harmonien und Kontrasten von Farben und Formen neue dekorative Möglichkeiten eröffnen. ● DE

Grandes figuras geométricas con formas esenciales que casi se mezclan con la arquitectura interior cuando se apagan, para revelar inesperadas armonías de luz y sombras una vez encendidas. Nuevos acabados mate calientan los paneles geométricos de Puzzle Mega. Pinturas líquidas que brindan nuevas posibilidades decorativas jugando con armonías y contrastes de colores y formas. ● ES

Крупные геометрические фигуры с простыми строгими формами, которые почти полностью сливаются с архитектурой интерьера, когда они выключены. Но стоит их включить, как вы увидите неожиданную и гармоничную игру света и тени. Новые матовые отделки согревают геометрические панели Puzzle Mega. Жидкие эмали, открывающие новые декоративные возможности, играя с гармонией и контрастами цветов и форм. ● RU

该灯具具有大型几何图形的基本形状，关闭时，几乎与内部架构融为一体，一旦打开，会发现意想不到的光影和谐。全新哑光饰面为Puzzle Mega的几何面板带来温暖。液体涂料通过色彩和形状的和谐与对比开辟了新的装饰可能性。● ZH

Visit website:



Puzzle Mega round small › Wall lamp



Puzzle Mega round large › Wall lamp



Puzzle Mega square small › Wall lamp



Puzzle Mega square large › Wall lamp



Puzzle Mega round small › Ceiling lamp



Puzzle Mega round large › Ceiling lamp



Puzzle Mega square small › Ceiling lamp



Puzzle Mega square large › Ceiling lamp



Puzzle Mega, standard version and extension optional version



Puzzle Mega, design by Studio Italia Design, 2019

Wall lamp Ceiling lamp

Puzzle Mega round small

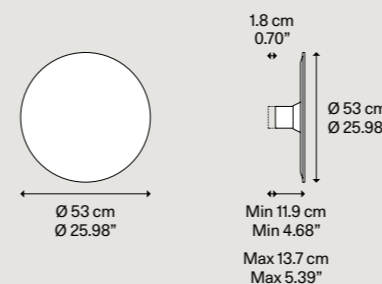

Light source
Sorgente luminosa

LED
 ↘ 2700 K
 ↘ 3 × 15 W/5250 lm
 ↘ 220-240 V
 ↘ CRI 92
 ↘ MacAdam 3-Step

or

LED
 ↘ 3000 K
 ↘ 3 × 15 W/5550 lm
 ↘ 220-240 V
 ↘ CRI 92
 ↘ MacAdam 3-Step

LED included
LED incluso

Metal structure
Montatura in metallo

Matte White - 9016
Bianco Opaco - 9016

Matte White - 9016
Bianco Opaco - 9016

MDF diffuser
Diffusore in MDF

Matte White - 9016
Bianco Opaco - 9016

Matte Black - 9005 **NEW**
Nero Opaco - 9005

Taupe **NEW**
Grigio Caldo

Red **NEW**
Rosso

Matte White - 9016
Bianco Opaco - 9016

Matte Black - 9005 **NEW**
Nero Opaco - 9005

Taupe **NEW**
Grigio Caldo

Red **NEW**
Rosso

Code
Codice

16741 1027

16741 2027

16741 3927

16741 6027

16741 1030

16741 2030

16741 3930

16741 6030

Net weight/Peso netto: 3.8 kg

Pack/Colli: 2

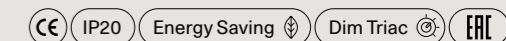

Puzzle Mega round large

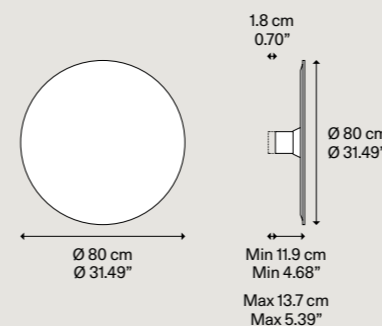

LED
 ↘ 2700 K
 ↘ 4 × 15 W/7000 lm
 ↘ 220-240 V
 ↘ CRI 92
 ↘ MacAdam 3-Step

or

LED
 ↘ 3000 K
 ↘ 4 × 15 W/7400 lm
 ↘ 220-240 V
 ↘ CRI 92
 ↘ MacAdam 3-Step

LED included
LED incluso

Matte White - 9016
Bianco Opaco - 9016

Matte White - 9016
Bianco Opaco - 9016

Matte White - 9016
Bianco Opaco - 9016

Matte Black - 9005 **NEW**
Nero Opaco - 9005

Taupe **NEW**
Grigio Caldo

Red **NEW**
Rosso

Matte White - 9016
Bianco Opaco - 9016

Matte Black - 9005 **NEW**
Nero Opaco - 9005

Taupe **NEW**
Grigio Caldo

Red **NEW**
Rosso

16744 1027

16744 2027

16744 3927

16744 6027

16744 1030

16744 2030

16744 3930

16744 6030

Net weight/Peso netto: 7.2 kg

Pack/Colli: 2

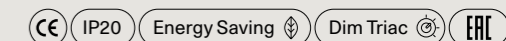

► LED sources with direct power supply to the AC line voltage - driver not required. Dimmable with phase cut dimmer.
 ► You can connect up to 4 Puzzle Mega to each fixture directly connected to the power supply. You can also connect up to 3 additional fixtures to each of those for maximum total of 36 fixtures on a single power outlet.

► LED con alimentazione diretta a tensione di rete - non necessita di driver. Dimmerabile con varialuce a taglio di fase.
 ► Ad ogni Puzzle Mega connessa al punto di alimentazione elettrica possono esserne collegate altre 4. Ad ognuna di queste possono esserne collegate fino ad altre 3 e così via. Le lampade totali collegabili su un singolo punto di alimentazione sono 36.

Puzzle Mega, design by Studio Italia Design, 2019

Wall lamp Ceiling lamp

Puzzle Mega square small

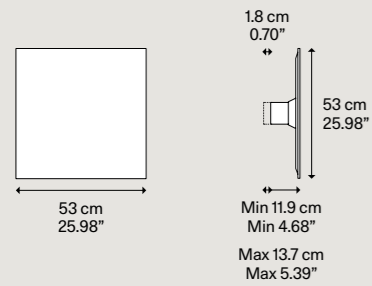

Light source Sorgente luminosa	Metal structure Montatura in metallo	MDF diffuser Diffusore in MDF	Code Codice
LED ↳ 2700 K ↳ 3 × 15 W/5250 lm ↳ 220-240 V ↳ CRI 92 ↳ MacAdam 3-Step	● Matte White - 9016 Bianco Opaco - 9016	● Matte White - 9016 Bianco Opaco - 9016	16742 1027
		● Matte Black - 9005 NEW Nero Opaco - 9005	16742 2027
		● Taupe NEW Grigio Caldo	16742 3927
LED ↳ 3000 K ↳ 3 × 15 W/5550 lm ↳ 220-240 V ↳ CRI 92 ↳ MacAdam 3-Step	● Matte White - 9016 Bianco Opaco - 9016	● Red NEW Rosso	16742 6027
		● Matte White - 9016 Bianco Opaco - 9016	16742 1030
		● Matte Black - 9005 NEW Nero Opaco - 9005	16742 2030
		● Taupe NEW Grigio Caldo	16742 3930
		● Red NEW Rosso	16742 6030
LED included LED incluso			

Net weight/Peso netto: 4.1 kg Pack/Colli: 2

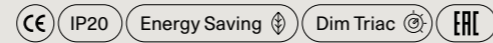

Puzzle Mega square large

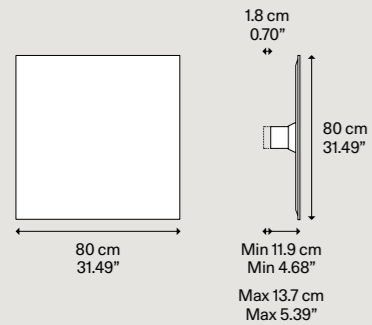

Light source Sorgente luminosa	Metal structure Montatura in metallo	MDF diffuser Diffusore in MDF	Code Codice
LED ↳ 2700 K ↳ 4 × 15 W/7000 lm ↳ 220-240 V ↳ CRI 92 ↳ MacAdam 3-Step	● Matte White - 9016 Bianco Opaco - 9016	● Matte White - 9016 Bianco Opaco - 9016	16745 1027
		● Matte Black - 9005 NEW Nero Opaco - 9005	16745 2027
		● Taupe NEW Grigio Caldo	16745 3927
LED ↳ 3000 K ↳ 4 × 15 W/7400 lm ↳ 220-240 V ↳ CRI 92 ↳ MacAdam 3-Step	● Matte White - 9016 Bianco Opaco - 9016	● Red NEW Rosso	16745 6027
		● Matte White - 9016 Bianco Opaco - 9016	16745 1030
		● Matte Black - 9005 NEW Nero Opaco - 9005	16745 2030
		● Taupe NEW Grigio Caldo	16745 3930
		● Red NEW Rosso	16745 6030
LED included LED incluso			

Net weight/Peso netto: 8.8 kg Pack/Colli: 2

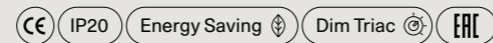

► LED sources with direct power supply to the AC line voltage - driver not required. Dimmable with phase cut dimmer.
► You can connect up to 4 Puzzle Mega to each fixture directly connected to the power supply. You can also connect up to 3 additional fixtures to each of those for maximum total of 36 fixtures on a single power outlet.

► LED con alimentazione diretta a tensione di rete - non necessita di driver. Dimmerabile con varialuce a taglio di fase.
► Ad ogni Puzzle Mega connessa al punto di alimentazione elettrica possono esserne collegate altre 4. Ad ognuna di queste possono esserne collegate fino ad altre 3 e così via. Le lampade totali collegabili su un singolo punto di alimentazione sono 36.

Puzzle Mega, design by Studio Italia Design, 2019

Accessory

Puzzle Mega extension

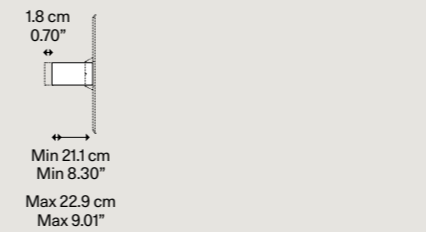

Net weight/Peso netto: 0.86 kg Pack/Colli: 1

Description Descrizione	Metal structure Montatura in metallo	Code Codice
Extension optional Estensione opzionale	● Matte White - 9016 Bianco Opaco - 9016	16799 A200
To be used to widen the light beam in case of ceiling installation		
Da utilizzare per ampliare il fascio luminoso in caso di installazione a soffitto		
Description Descrizione	Metal structure Montatura in metallo	Code Codice
Accessory connector		
Connection Collegamento		16799 A100
To be used to connect the fixtures together in the compositions		
Da utilizzare per collegare le lampade tra loro nelle composizioni		
<p>Net weight/Peso netto: 0.10 kg Pack/Colli: 1</p>		

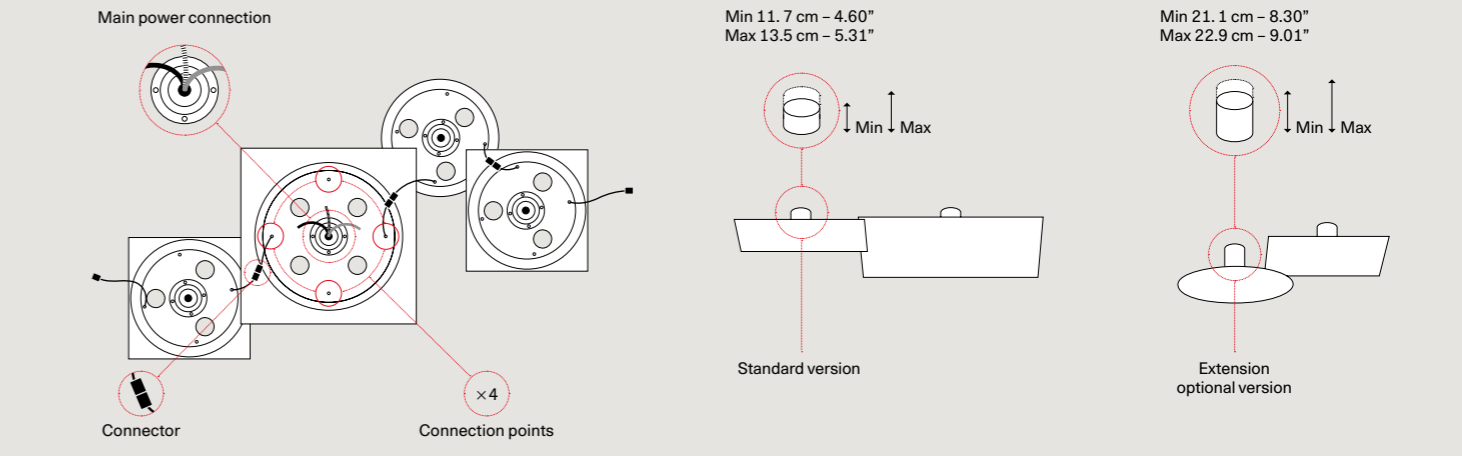

► LED sources with direct power supply to the AC line voltage - driver not required. Dimmable with phase cut dimmer.
► You can connect up to 4 Puzzle Mega to each fixture directly connected to the power supply. You can also connect up to 3 additional fixtures to each of those for maximum total of 36 fixtures on a single power outlet.

► LED con alimentazione diretta a tensione di rete - non necessita di driver. Dimmerabile con varialuce a taglio di fase.
► Ad ogni Puzzle Mega connessa al punto di alimentazione elettrica possono esserne collegate altre 4. Ad ognuna di queste possono esserne collegate fino ad altre 3 e così via. Le lampade totali collegabili su un singolo punto di alimentazione sono 36.

Puzzle Round

With its soft shapes, flexible joints and LED light source, Puzzle Round can be adjusted at will to create striking light effects on walls and ceilings. The unobtrusive aesthetics and the four available finishes, now including Champagne, make it perfect for the most varied living contexts.

Con le sue forme morbide, i giunti flessibili e la sorgente luminosa a LED, Puzzle Round può essere regolata a piacimento per creare suggestivi giochi di luce su pareti e soffitti. L'estetica discreta e le quattro finiture disponibili, ora anche Champagne, la rendono perfetta per i più svariati contesti abitativi.

Wall lamp, Ceiling lamp

Puzzle Round single and double,
FINISH Champagne

Puzzle Round, *design by* Studio Italia Design, 2016

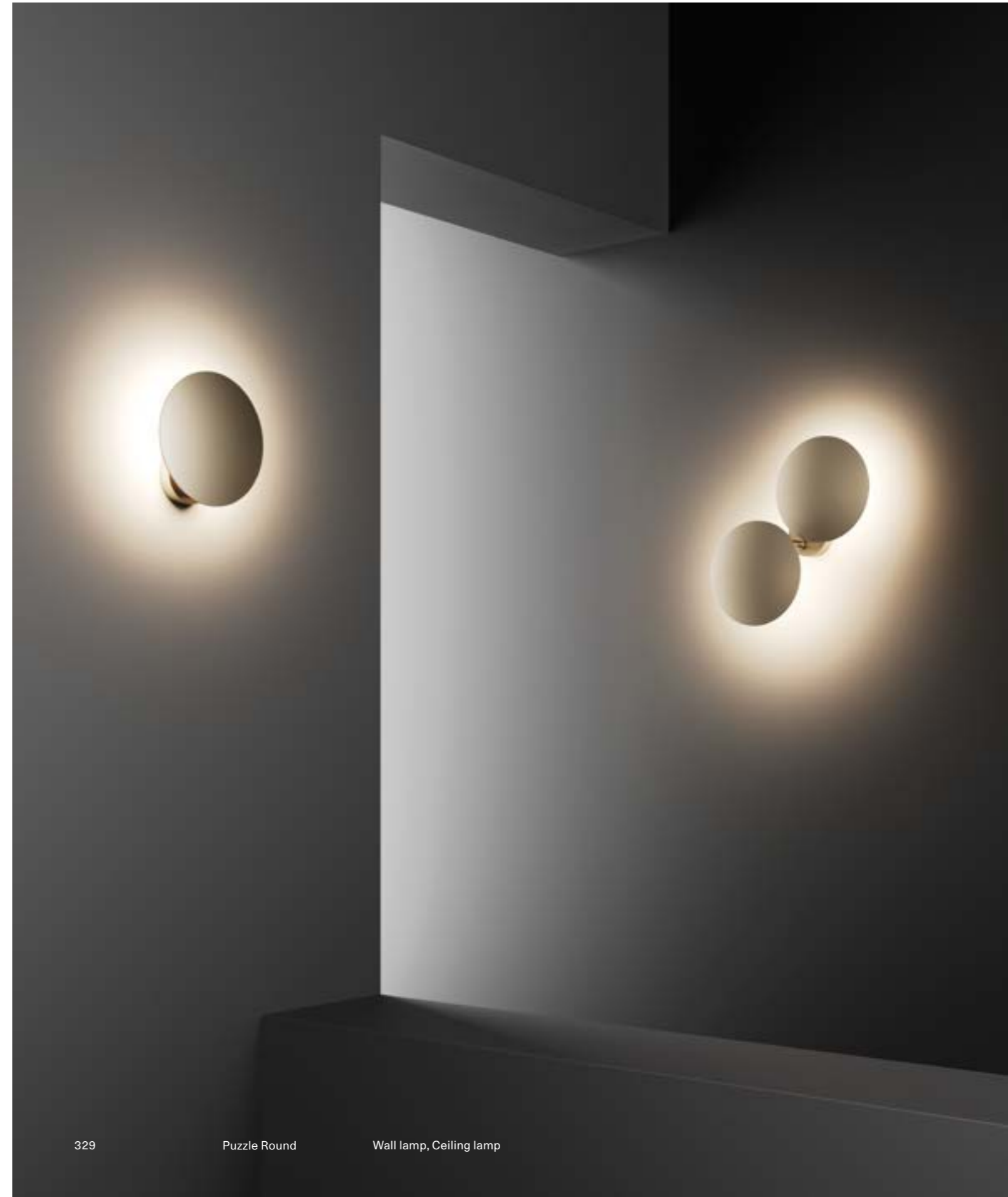



Puzzle Round single and double, FINISH Champagne



Puzzle Round double,
FINISH Matte Black



1, 2–Puzzle Round single,
FINISH Matte White

Puzzle Round double,
FINISH Champagne



Puzzle Round double, FINISH Champagne



Puzzle Round single, FINISH Coppery Bronze



Puzzle Round double, FINISH Matte White

Avec ses formes souples, les joints flexibles et la source lumineuse à LED, Puzzle Round peut être réglée à discrétion pour créer des jeux de lumière suggestifs sur les murs et les plafonds. Son esthétique discrète et les quatre finitions disponibles, y compris le Champagne, la rendent parfaite pour des contextes de vie variés. ●FR

Durch ihre weichen Formen, die flexiblen Gelenke und die LED-Lichtquelle kann Puzzle Round nach Belieben eingestellt werden, um wunderbare Lichtspiele an Wänden und Decken entstehen zu lassen. Die unauffällige Ästhetik und die vier verfügbaren Ausführungen - jetzt auch Champagner - machen die Leuchte perfekt für verschiedene Wohnbereiche. ●DE

Con sus formas suaves, articulaciones flexibles y fuente de luz LED, Puzzle Round puede ajustarse a voluntad para crear sorprendentes efectos de luz en paredes y techos. La estética discreta y los cuatro acabados disponibles, ahora incluyendo Champán, lo hacen perfecto para una amplia variedad de entornos. ●ES

Благодаря своим мягким формам, гибким соединительным элементам и источнику света LED, светильник Puzzle Round можно регулировать по желанию для создания эффектной игры света на стенах и потолках. Неброский дизайн и четыре доступных варианта отделки, теперь включающие Шампанне, делают его идеальным для разных жилых контекстов. ●RU

柔软的外形，灵活的接头和LED光源，Puzzle Round 可以根据需要进行调整，以在墙壁和天花板上营造出光线的暗示性。谨慎的美学设计以及如今包含香槟色在内的四种可用颜色，使其非常适合各种房屋环境。●ZH

Visit website:



Puzzle Round single » Wall lamp

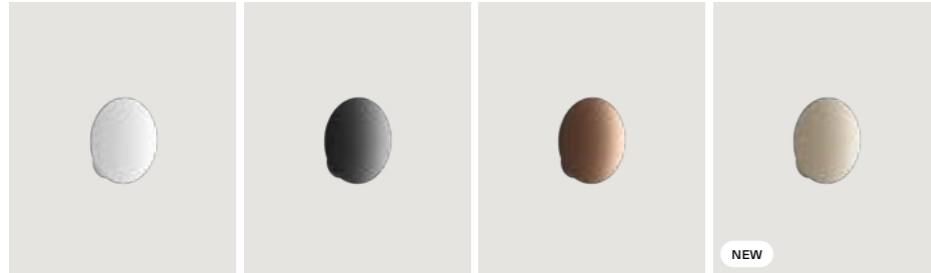

Puzzle Round single » Ceiling lamp



Puzzle Round double » Wall lamp

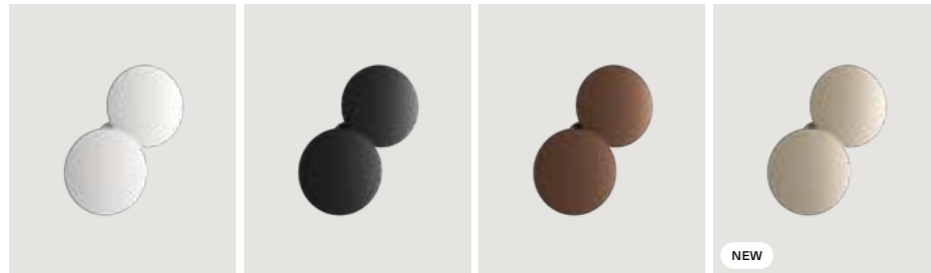

Puzzle Round double » Ceiling lamp



Puzzle Round, design by Studio Italia Design, 2016

Wall lamp

Ceiling lamp

Puzzle Round single

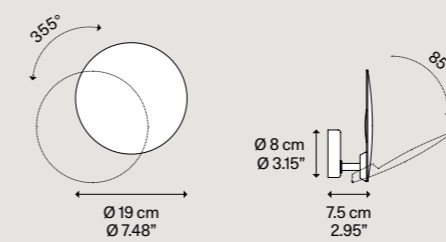

Light source
Sorgente luminosa

LED
» 2700 K
» 15 W/1750 lm
» 220-240 V
» CRI 92
» MacAdam 3-Step

LED
» 3000 K
» 15 W/1850 lm
» 220-240 V
» CRI 92
» MacAdam 3-Step

LED included
LED incluso



Adjustable light
Luce orientabile

Net weight/Peso netto: 0.6 kg

Pack/Colli: 1

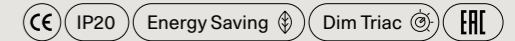

Puzzle Round double

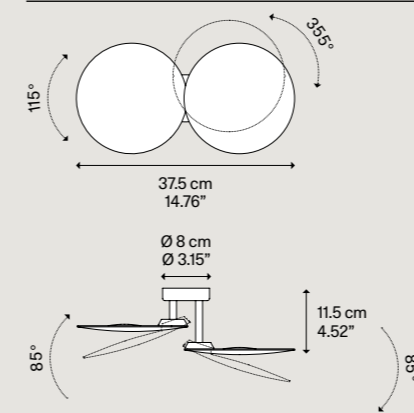

LED
» 2700 K
» 2 x 15 W/3500 lm
» 220-240 V
» CRI 92
» MacAdam 3-Step

LED
» 3000 K
» 2 x 15 W/3700 lm
» 220-240 V
» CRI 92
» MacAdam 3-Step

LED included
LED incluso



Adjustable light
Luce orientabile

Net weight/Peso netto: 1.1 kg

Pack/Colli: 1

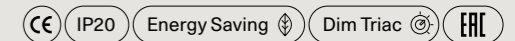

LED sources with direct power supply to the AC line voltage – driver not required. Dimmable with phase cut dimmer.

LED con alimentazione diretta a tensione di rete – non necessita di driver. Dimmerabile con varialuce a taglio di fase.

Puzzle

Essential forms in metal, square and rectangular, which seem to disappear in the ceiling or wall. Clear-cut geometries that create suggestive plays of light on walls and ceilings, making for a truly personalised atmosphere. With Puzzle lamps, light becomes the feature element of living spaces, creating soft, geometric effects.

Forme essenziali in metallo, quadrati e rettangoli che sembrano scomparire nel soffitto o nella parete. Geometria rigorose che possono essere regolate a piacimento per creare suggestivi giochi di luce su pareti e soffitti, rendendo l'atmosfera del tutto personale. Le lampade Puzzle rendono la luce il vero ornamento degli ambienti abitativi creando effetti di morbide geometrie.

Wall lamp, Ceiling lamp

Puzzle single square,
FINISH Matte Black

Puzzle, *design by* Studio Italia Design, 2014

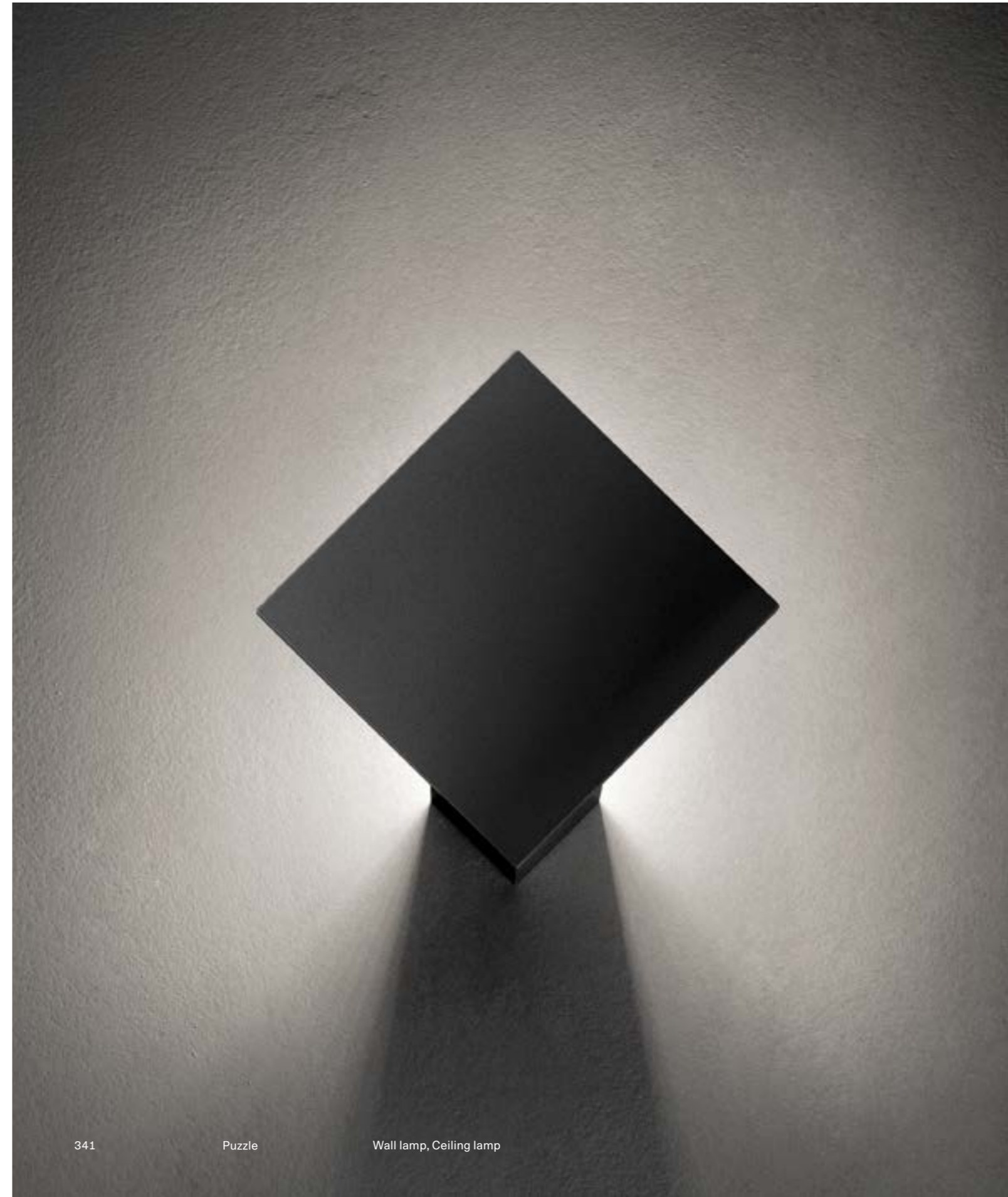



Puzzle double square,
FINISH Matte Black

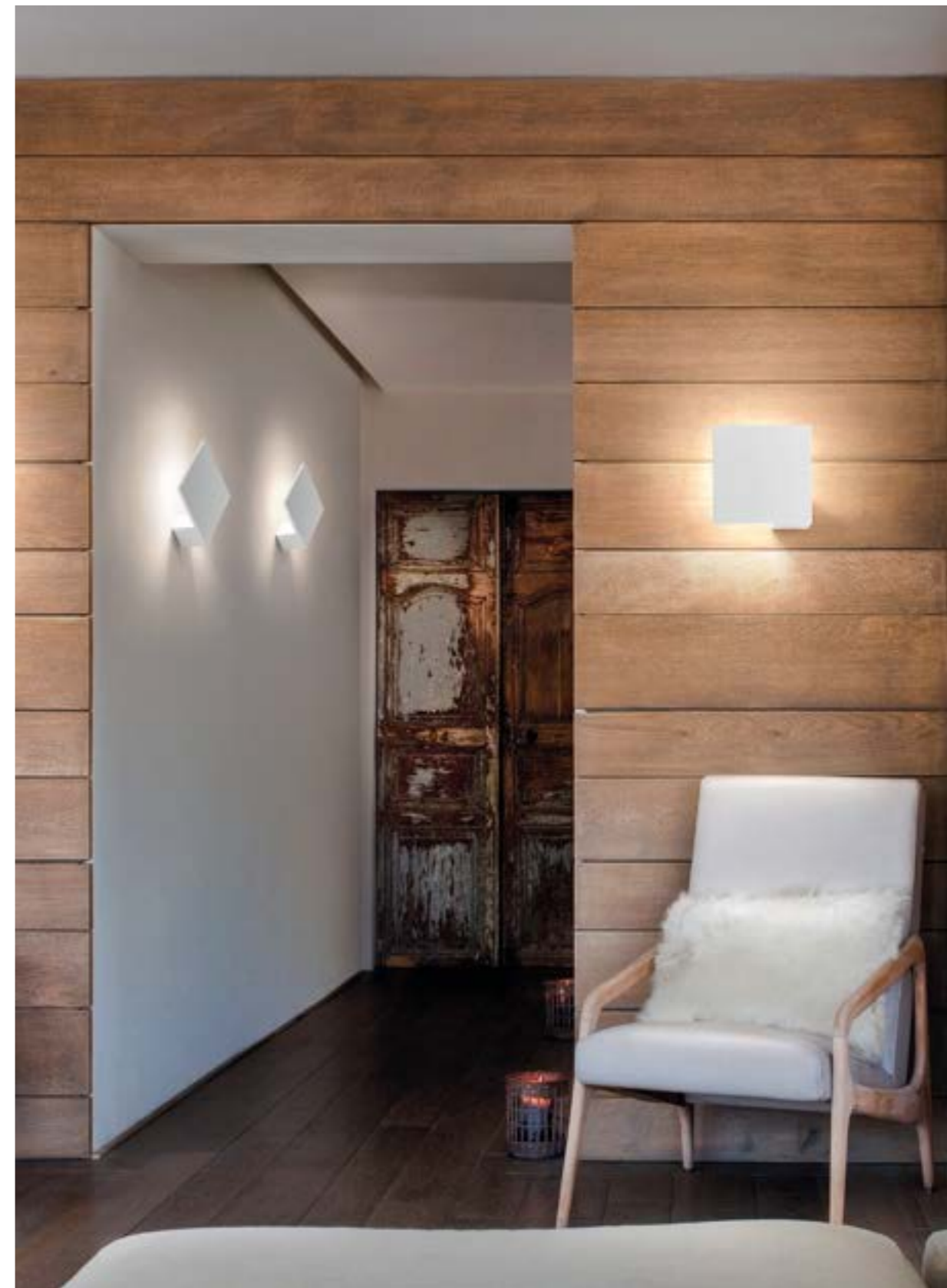

Puzzle single square, FINISH Matte White



Puzzle square & rectangle, FINISH Matte White



Puzzle double square, FINISH Matte White

Formes essentielles en métal, carrées et rectangulaires qui semblent disparaître dans le plafond ou le mur. Des géométries rigoureuses qui créent des jeux de lumières suggestifs sur les murs et plafonds pour créer une atmosphère personnelle. Les lampes Puzzle font de la lumière une décoration des espaces de vie et créent des effets géométriques harmonieux. ● FR

Einfache Formen aus Metall, quadratisch und rechteckig, die in der Decke oder in der Wand zu verschwinden scheinen. Klare Geometrien, die an Wänden und Decken wunderbare Lichtspiele erzeugen, um die Atmosphäre vollkommen persönlich zu gestalten. Die Leuchten Puzzle machen das Licht zum wahren Ornament von Wohnräumen und lassen Effekte mit weicher geometrischer Form entstehen. ● DE

Formas esenciales de metal, cuadrados y rectángulos que parecen desaparecer en el techo o la pared. Rigurosas geometrías que crean suggestivos efectos de luz en paredes y techos haciendo que la atmósfera sea completamente personal. Las lámparas Puzzle hacen que la luz sea el verdadero ornamento de los espacios habitables, creando efectos de geometrías suaves. ● ES

Простые формы из металла, квадраты и прямоугольники, которые как бы исчезают в потолке или стене. Строгие геометрические формы, которые можно отрегулировать по своему вкусу, создавая живописную игру света на стенах и потолках и полностью персонализируя атмосферу. Светильники Puzzle превращают свет в истинный декоративный элемент жилых интерьеров, создавая мягкие геометрические эффекты. ● RU

基本的金属形状，是似乎在吸顶灯和壁灯中消失的正方形和矩形。严格的几何形状可以随意调节，在墙壁和天花板上营造出暗示性的光线，使氛围完全个性化。Puzzle灯通过创造柔和的几何效果，使照明成为生活空间的真正装饰品。● ZH

Visit website:



Puzzle single square ↘ Wall lamp

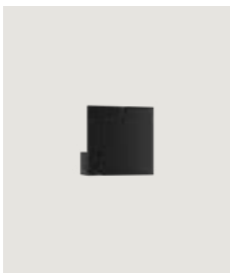

Puzzle single square ↘ Ceiling lamp



Puzzle double square ↘ Wall lamp



Puzzle double square ↘ Ceiling lamp



Puzzle square & rectangle ↘ Wall lamp



Puzzle square & rectangle ↘ Ceiling lamp



Puzzle, design by Studio Italia Design, 2014

Wall lamp

Ceiling lamp

Puzzle single square

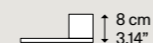
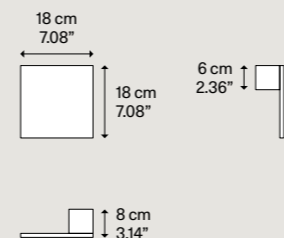

Light source
Sorgente luminosa

LED
↘ 2700 K
↘ 15 W/1750 lm
↘ 220-240 V
↘ CRI 92
↘ MacAdam 3-Step

LED
↘ 3000 K
↘ 15 W/1850 lm
↘ 220-240 V
↘ CRI 92
↘ MacAdam 3-Step

LED included
LED incluso

Metal structure
Montatura in metallo

● Matte White – 9016
Bianco Opaco – 9016

● Matte Black – 9005
Nero Opaco – 9005

● Matte White – 9016
Bianco Opaco – 9016

● Matte Black – 9005
Nero Opaco – 9005

Code
Codice

14641 1027

14641 2027

14641 1030

14641 2030

Net weight/Peso netto: 1.16 kg

Pack/Colli: 1

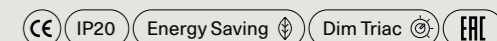

Puzzle double square

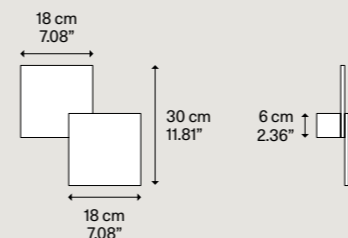

LED
↘ 2700 K
↘ 2 x 15 W/3500 lm
↘ 220-240 V
↘ CRI 92
↘ MacAdam 3-Step

LED
↘ 3000 K
↘ 2 x 15 W/3700 lm
↘ 220-240 V
↘ CRI 92
↘ MacAdam 3-Step

LED included
LED incluso

● Matte White – 9016
Bianco Opaco – 9016

● Matte Black – 9005
Nero Opaco – 9005

● Matte White – 9016
Bianco Opaco – 9016

● Matte Black – 9005
Nero Opaco – 9005

14642 1027

14642 2027

14642 1030

14642 2030

Net weight/Peso netto: 2 kg

Pack/Colli: 1

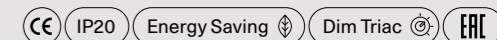

Puzzle square & rectangle

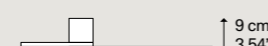
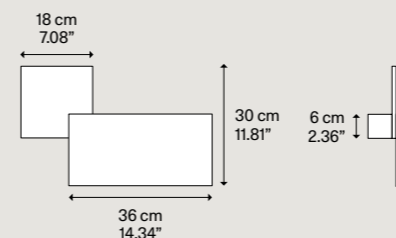

LED
↘ 2700 K
↘ 2 x 15 W/3500 lm
↘ 220-240 V
↘ CRI 92
↘ MacAdam 3-Step

LED
↘ 3000 K
↘ 2 x 15 W/3700 lm
↘ 220-240 V
↘ CRI 92
↘ MacAdam 3-Step

LED included
LED incluso

● Matte White – 9016
Bianco Opaco – 9016

● Matte Black – 9005
Nero Opaco – 9005

● Matte White – 9016
Bianco Opaco – 9016

● Matte Black – 9005
Nero Opaco – 9005

14643 1027

14643 2027

14643 1030

14643 2030

Net weight/Peso netto: 2.91 kg

Pack/Colli: 1

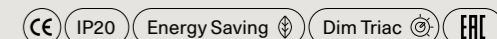

► LED sources with direct power supply to the AC line voltage – driver not required. Dimmable with phase cut dimmer.
► Optional backplate available.

► LED con alimentazione diretta a tensione di rete – non necessita di driver. Dimmerabile con varialuce a taglio di fase.
► Disponibile piastra a muro opzionale.

Puzzle Outdoor

Puzzle Outdoor is a collection designed to enhance the outdoor spaces of homes and buildings, from the façade to the terrace, making them pleasant and comfortable at any time of day. Discrete by day, adaptable to any type of architecture, these lamps featured in essential shapes light up suggestive atmospheres after sundown.

Puzzle Outdoor è una collezione progettata per valorizzare gli spazi esterni di abitazioni ed edifici, dalla facciata alla terrazza, e renderli piacevoli e confortevoli in ogni momento della giornata. Discrete di giorno, adatte ad ogni tipo di architettura, queste lampade dalle geometrie essenziali accendono atmosfere suggestive dopo il tramonto.

Wall lamp

Puzzle Outdoor round double,
FINISH Matte White

Puzzle Outdoor, *design by* Studio Italia Design, 2019

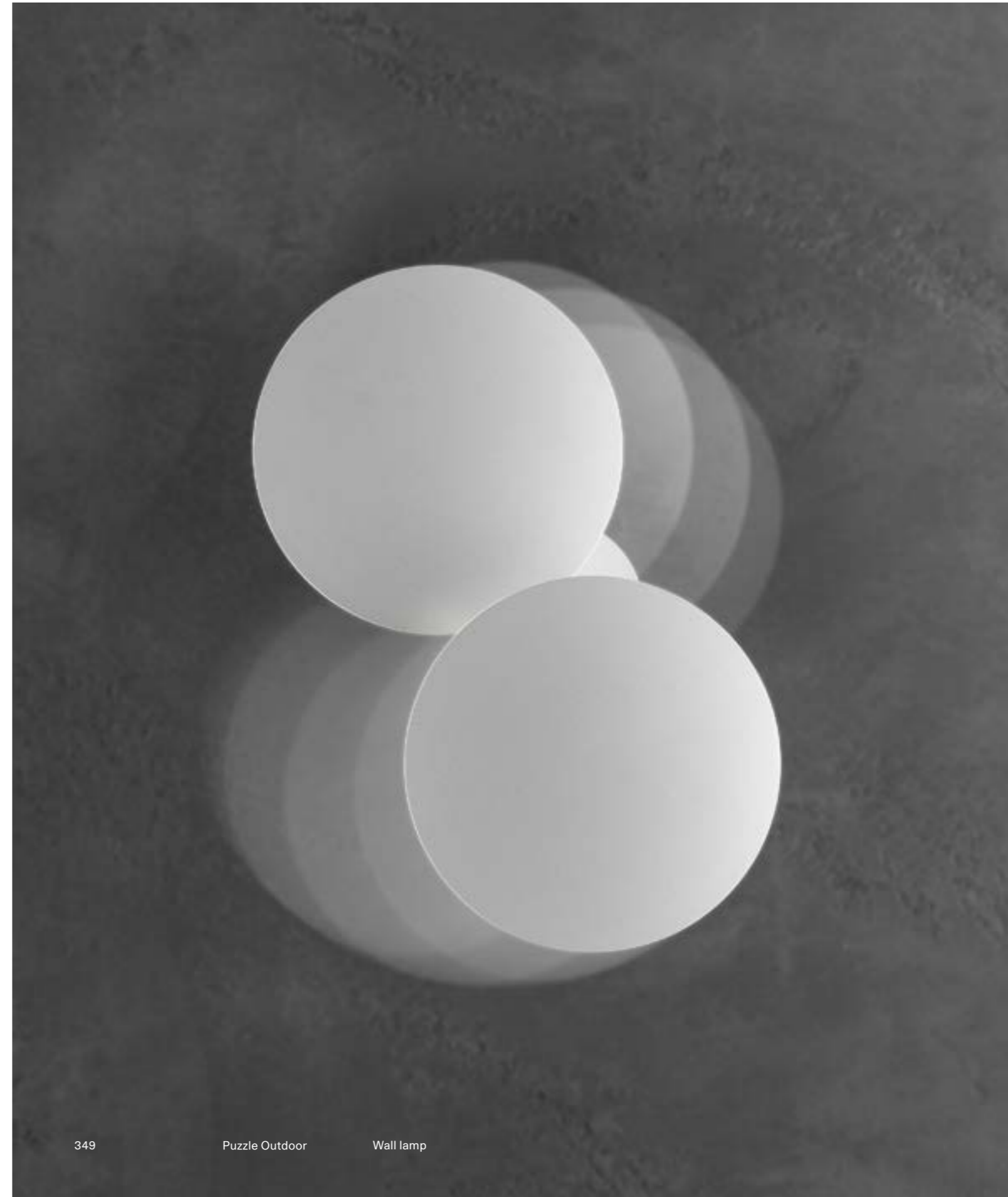



Puzzle Outdoor single square
and square & rectangle,
FINISH Anthracite Black

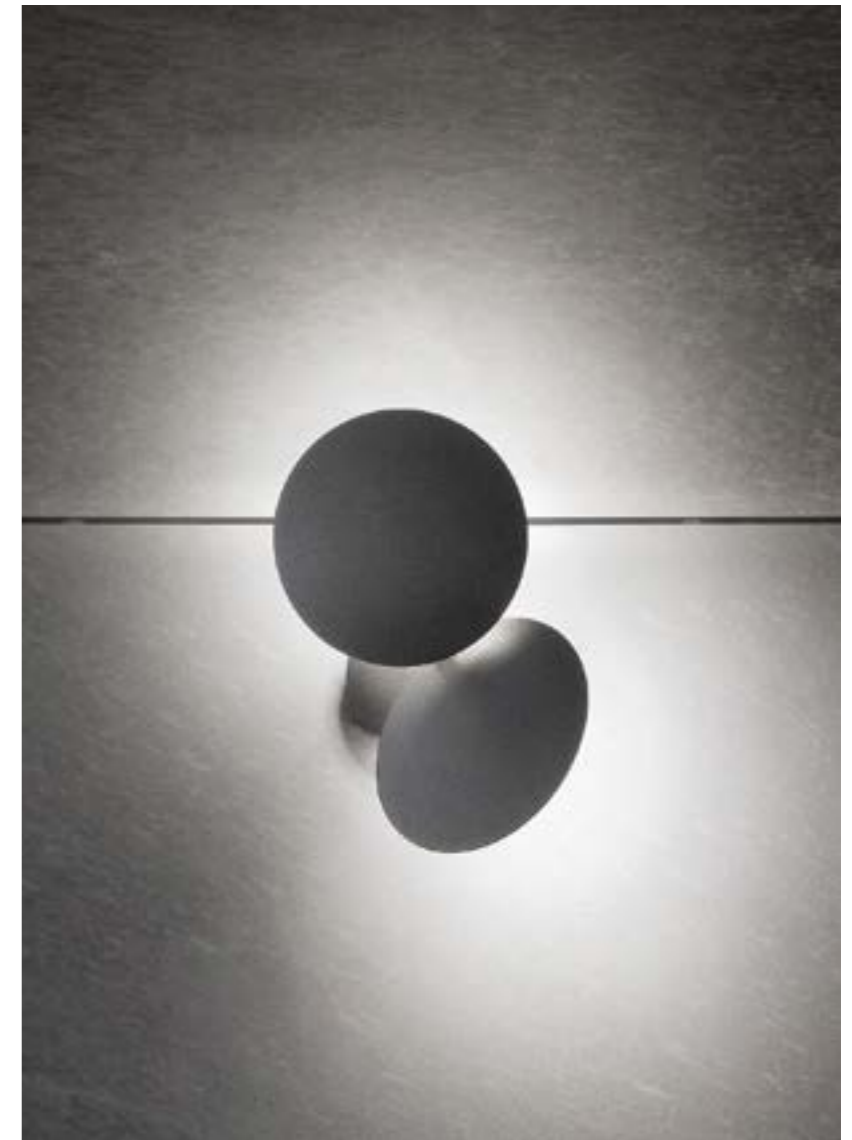

Puzzle Outdoor round double,
FINISH Anthracite Black



Puzzle Outdoor round single,
FINISH Matte White

Puzzle Outdoor est une collection conçue pour valoriser les espaces extérieurs des habitations et des bâtiments, de la façade à la terrasse, et les rendre plaisants et confortables à tout moment de la journée. Discret le jour, adapté à tout type d'architecture, ces luminaires aux géométries essentielles offrent une atmosphère suggestive après le coucher du soleil. ● FR

Puzzle Outdoor ist eine Kollektion, die entworfen wurde, um Außenräumen von Wohn- und öffentlichen Gebäuden von der Fassade bis hin zur Terrasse in Szene zu setzen und zu jeder Tageszeit angenehm und wohlig zu machen. Tagsüber diskret und für jeden Architekturstil geeignet, lassen diese Leuchten mit einfacher Form nach dem Sonnenuntergang wunderbare Atmosphären entstehen. ● DE

Puzzle Outdoor es una colección diseñada para realizar los espacios exteriores de las casas y edificios, desde la fachada hasta la terraza, y hacerlos agradables y cómodos a cualquier hora del día. Discretas durante el día, adecuadas para todo tipo de arquitectura, estas lámparas de geometría esencial iluminan sugestivas atmósferas después del atardecer. ● ES

Puzzle Outdoor – это коллекция, разработанная для оформления и освещения наружных пространств домов и зданий, от фасада до террасы, чтобы сделать их привлекательными и комфортными в любое время суток. Неброские в дневное время, подходящие для любого типа архитектуры, после захода солнца эти светильники с простым геометрическим дизайном освещают и создают восхитительную атмосферу. ● RU

Puzzle Outdoor系列旨在改善房屋和建筑物的户外空间，从外墙到露台，使其在一天中的任何时候都舒适宜人。白天不太显眼，适合任何类型的建筑，该款灯具具有基本的几何形状，在日落之后会散发出令人愉悦的气氛。● ZH

Visit website:



Puzzle Outdoor single square › Wall lamp

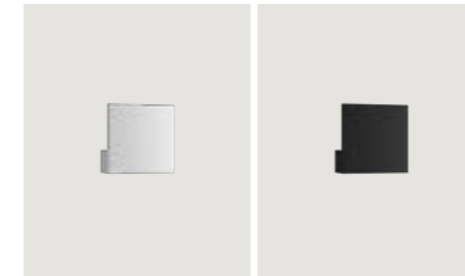

Puzzle Outdoor round single › Wall lamp



Puzzle Outdoor double square › Wall lamp

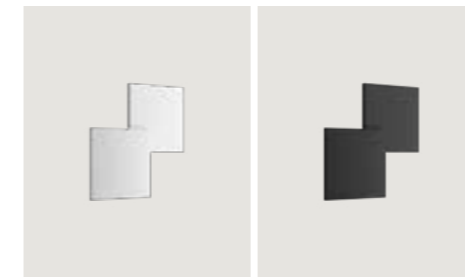

Puzzle Outdoor round double › Wall lamp

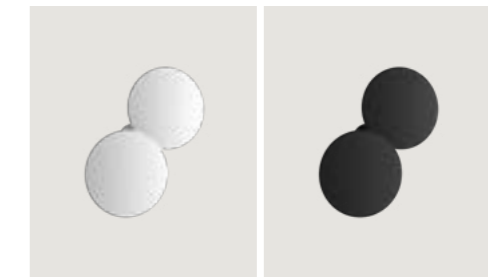

Puzzle Outdoor square & rectangle › Wall lamp

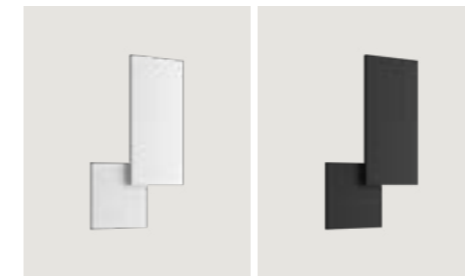

Puzzle Outdoor, design by Studio Italia Design, 2019

Wall lamp

Puzzle Outdoor single square

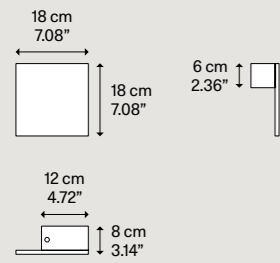

Light source
Sorgente luminosa

LED
 ↗ 3000 K
 ↗ 16 W/1700 lm
 ↗ 220-240 V
 ↗ CRI 92
 ↗ MacAdam 3-Step

Metal structure
Montatura in metallo

● Matte White - 9016
Bianco Opaco - 9016

● Anthracite Black
Nero Antracite

Code
Codice

14693 1030

14693 4430

LED included
LED incluso

Net weight/Peso netto: 1.34 kg

Pack/Colli: 1

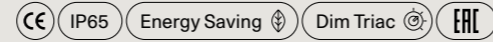

Puzzle Outdoor double square

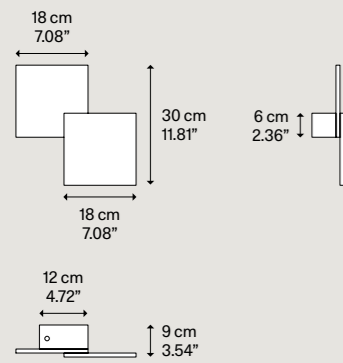

LED
 ↗ 3000 K
 ↗ 2 x 16 W/3400 lm
 ↗ 220-240 V
 ↗ CRI 92
 ↗ MacAdam 3-Step

● Matte White - 9016
Bianco Opaco - 9016

● Anthracite Black
Nero Antracite

14692 1030

14692 4430

LED included
LED incluso

Net weight/Peso netto: 2.27 kg

Pack/Colli: 1

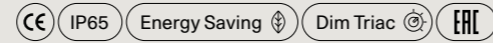

Puzzle Outdoor square & rectangle

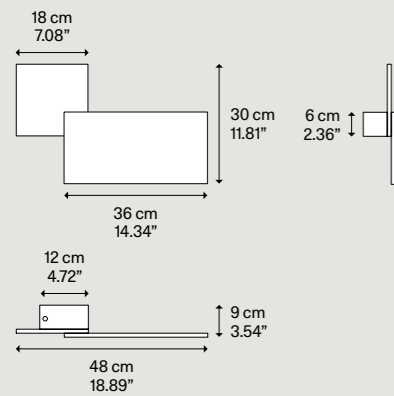

LED
 ↗ 3000 K
 ↗ 2 x 16 W/3400 lm
 ↗ 220-240 V
 ↗ CRI 92
 ↗ MacAdam 3-Step

● Matte White - 9016
Bianco Opaco - 9016

● Anthracite Black
Nero Antracite

14694 1030

14694 4430

LED included
LED incluso

Net weight/Peso netto: 3.24 kg

Pack/Colli: 1

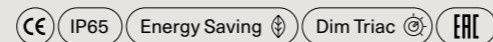

LED sources with direct power supply to the AC line voltage - driver not required. Dimmable with phase cut dimmer.

LED con alimentazione diretta a tensione di rete - non necessita di driver. Dimmerabile con varialuce a taglio di fase.

Puzzle Outdoor, design by Studio Italia Design, 2019

Wall lamp

Puzzle Outdoor round single

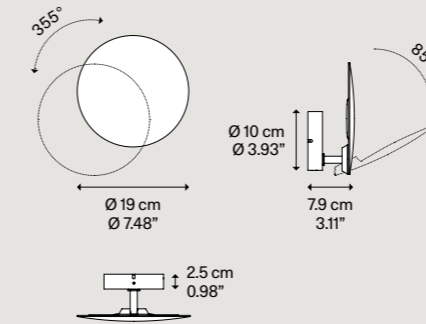

Light source
Sorgente luminosa

LED
 ↗ 3000 K
 ↗ 16 W/1700 lm
 ↗ 220-240 V
 ↗ CRI 92
 ↗ MacAdam 3-Step

Metal structure
Montatura in metallo

● Matte White - 9016
Bianco Opaco - 9016

● Anthracite Black
Nero Antracite

Code
Codice

15991 1030

15991 4430

LED included
LED incluso



Adjustable light
Luce orientabile

Net weight/Peso netto: 0.72 kg

Pack/Colli: 1



Puzzle Outdoor round double

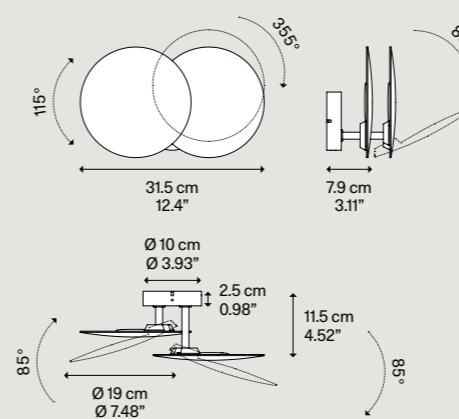

LED
 ↗ 3000 K
 ↗ 2 x 16 W/3400 lm
 ↗ 220-240 V
 ↗ CRI 92
 ↗ MacAdam 3-Step

● Matte White - 9016
Bianco Opaco - 9016

● Anthracite Black
Nero Antracite

15992 1030

15992 4430

LED included
LED incluso



Adjustable light
Luce orientabile

Net weight/Peso netto: 1.30 kg

Pack/Colli: 1

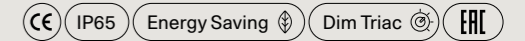

LED sources with direct power supply to the AC line voltage - driver not required. Dimmable with phase cut dimmer.

LED con alimentazione diretta a tensione di rete - non necessita di driver. Dimmerabile con varialuce a taglio di fase.

Bugia

Round, compact forms featuring elegant finishes with a centre that shines like a precious stone. Once lit up, Bugia amazes with the unexpected effect of its light. A surprising and harmonious balance between direct and indirect light, diffused both downward and up toward the ceiling. A rich family of ceiling lights, in Single, Double, Triple and now also Mega versions.

Forme rotonde compatte dalle finiture raffinate con un centro che splende come una pietra preziosa. Appena viene accesa, Bugia sorprende per l'effetto inaspettato della sua luce. Un inaspettato equilibrio armonico tra luce diretta e indiretta, diffusa sia verso il basso che verso il soffitto. Una ricca famiglia di plafoniere, in versione Single, Double, Triple e ora anche Mega.

Ceiling lamp

Bugia Triple and Mega,
FINISHES Chrome and Glossy Black

Bugia, *design by* Studio Italia Design, 2016/2020





Bugia Mega and Double, FINISH Glossy Bronze



Bugia Double, FINISH Chrome

Bugia Triple and Single,
FINISH Glossy White



Bugia Triple, Single, Mega and Double,
FINISHES Glossy White and Glossy Black



Bugia Single, FINISH Gold

Forme ronde compacte aux finitions raffinées avec un point central qui brille comme une pierre précieuse. Une fois allumée, Bugia surprend par l'effet inattendu de sa lumière. Un harmonieux équilibre inattendu entre lumière directe et indirecte, diffusée vers le bas ou vers le plafond. Une riche famille de plafonniers, en version Single, Double, Triple et maintenant Mega. ●FR

Kompakte, runde Formen mit raffinierten Ausführungen und einem Mittelpunkt, der wie ein Edelstein funkelt. Beim Einschalten überrascht Bugia durch den unerwarteten Effekt ihres Lichts. Ein unerwartet harmonisches Gleichgewicht zwischen direktem und indirektem Licht, das sowohl nach unten wie auch zur Decke gestrahlt wird. Eine ganze Familie von Deckenleuchten, in Single-, Double-, Triple- und jetzt auch Mega-Versionen. ●DE

Formas redondas compactas con acabados refinados con un centro que brilla como una piedra preciosa. Tan pronto como se enciende, Bugia sorprende con el inesperado efecto de su luz. Un inesperado equilibrio armónico entre la luz directa e indirecta, difusa tanto hacia abajo como hacia el techo. Una rica familia de lámparas de techo, en versiones Single, Double, Triple y ahora Mega. ●ES

Компактные круглые формы с изысканной отделкой, в центре которых как бы сияет драгоценный камень. Сразу же при включении светильник Bugia поражает своим потрясающим световым эффектом. Неожиданно уравновешенная гармония между прямым и непрямым светом, распространяющимся как вниз, так и к потолку. Богатая семья плафонов в вариации Single, Double, Triple и теперь Mega. ●RU

紧凑的圆形，精致的表面，中心像宝石一样闪闪发光。开启后，您会为Bugia灯光带来的意外效果感到惊讶。直射光和间接光之间出乎意料的和谐平衡，向下并向天花板扩散。丰富的天花板灯家族系列，有Single, Double, Triple, 现在还有Mega版本。●ZH

Visit website:



Bugia Single ↘ Ceiling lamp

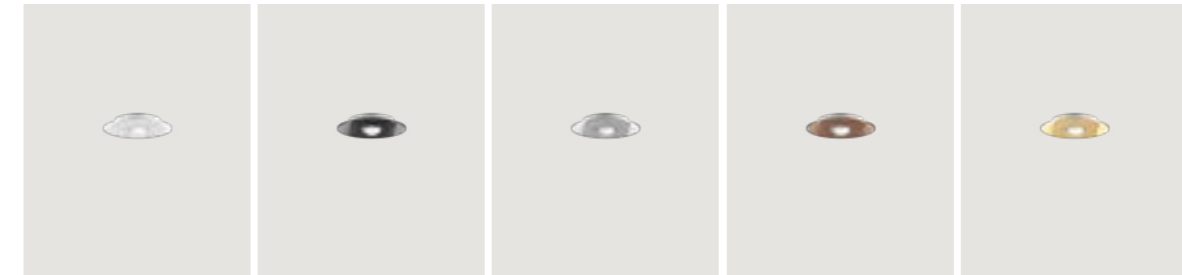

Bugia Double ↘ Ceiling lamp



Bugia Triple ↘ Ceiling lamp



Bugia Mega ↘ Ceiling lamp

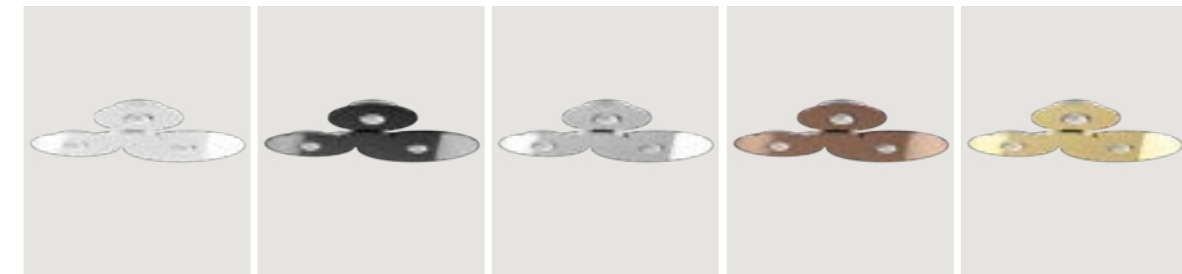

Bugia, design by Studio Italia Design, 2016

Ceiling lamp

Bugia Single

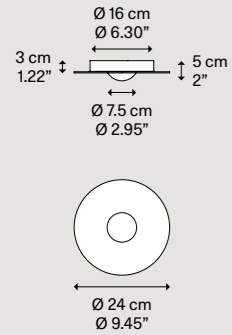

Light source Sorgente luminosa	Metal structure Montatura in metallo	Methacrylate diffuser Diffusore in metacrilato	Code Codice
LED ↗ 2700 K ↗ 15 W/1245 lm ↗ 220-240 V ↗ CRI 90 ↗ MacAdam 3-Step	<input type="radio"/> Matte White - 9010 Bianco Opaco - 9010	<input type="radio"/> Glossy White Bianco Lucido	16131 1227
		<input type="radio"/> Glossy Black Nero Lucido	16131 2227
		<input type="radio"/> Chrome Cromo	16131 4027
		<input type="radio"/> Glossy Bronze Bronzo Lucido	16131 4627
		<input type="radio"/> Gold Oro	16131 5027
LED included LED incluso	<input type="radio"/> Matte White - 9010 Bianco Opaco - 9010	<input type="radio"/> Glossy White Bianco Lucido	16131 1230
		<input type="radio"/> Glossy Black Nero Lucido	16131 2230
		<input type="radio"/> Chrome Cromo	16131 4030
		<input type="radio"/> Glossy Bronze Bronzo Lucido	16131 4630
		<input type="radio"/> Gold Oro	16131 5020

Net weight/Peso netto: 0.8 kg

Pack/Colli: 2

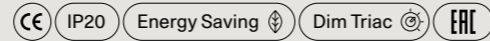

Bugia Double

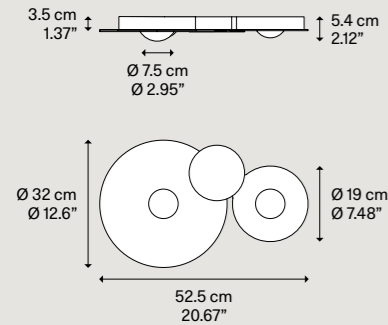

Light source Sorgente luminosa	Metal structure Montatura in metallo	Methacrylate diffuser Diffusore in metacrilato	Code Codice
LED ↗ 2700 K ↗ 2 x 15 W/2490 lm ↗ 220-240 V ↗ CRI 90 ↗ MacAdam 3-Step	<input type="radio"/> Matte White - 9010 Bianco Opaco - 9010	<input type="radio"/> Glossy White Bianco Lucido	16132 1227
		<input type="radio"/> Glossy Black Nero Lucido	16132 2227
		<input type="radio"/> Chrome Cromo	16132 4027
		<input type="radio"/> Glossy Bronze Bronzo Lucido	16132 4627
		<input type="radio"/> Gold Oro	16132 5027
LED included LED incluso	<input type="radio"/> Matte White - 9010 Bianco Opaco - 9010	<input type="radio"/> Glossy White Bianco Lucido	16132 1230
		<input type="radio"/> Glossy Black Nero Lucido	16132 2230
		<input type="radio"/> Chrome Cromo	16132 4030
		<input type="radio"/> Glossy Bronze Bronzo Lucido	16132 4630
		<input type="radio"/> Gold Oro	16132 5020

Net weight/Peso netto: 2.05 kg

Pack/Colli: 2

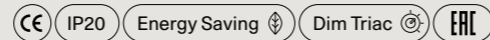

LED sources with direct power supply to the AC line voltage - driver not required. Dimmable with phase cut dimmer.

LED con alimentazione diretta a tensione di rete - non necessita di driver. Dimmerabile con varialuce a taglio di fase.

Bugia, design by Studio Italia Design, 2016

Ceiling lamp

Bugia Triple

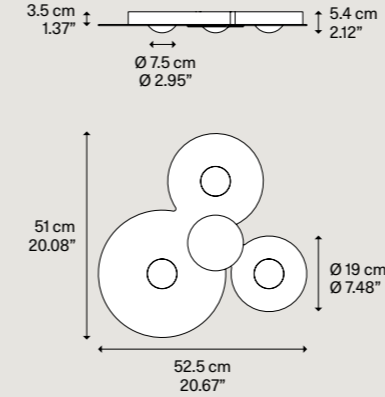

Light source Sorgente luminosa	Metal structure Montatura in metallo	Methacrylate diffuser Diffusore in metacrilato	Code Codice
LED ↗ 2700 K ↗ 3 x 15 W/3735 lm ↗ 220-240 V ↗ CRI 90 ↗ MacAdam 3-Step	<input type="radio"/> Matte White - 9010 Bianco Opaco - 9010	<input type="radio"/> Glossy White Bianco Lucido	16133 1227
		<input type="radio"/> Glossy Black Nero Lucido	16133 2227
		<input type="radio"/> Chrome Cromo	16133 4027
		<input type="radio"/> Glossy Bronze Bronzo Lucido	16133 4627
		<input type="radio"/> Gold Oro	16133 5027
LED included LED incluso	<input type="radio"/> Matte White - 9010 Bianco Opaco - 9010	<input type="radio"/> Glossy White Bianco Lucido	16133 1230
		<input type="radio"/> Glossy Black Nero Lucido	16133 2230
		<input type="radio"/> Chrome Cromo	16133 4030
		<input type="radio"/> Glossy Bronze Bronzo Lucido	16133 4630
		<input type="radio"/> Gold Oro	16133 5020

Net weight/Peso netto: 2.8 kg

Pack/Colli: 2

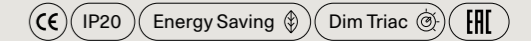

Bugia Mega, design by Studio Italia Design, 2020

Ceiling lamp

Bugia Mega

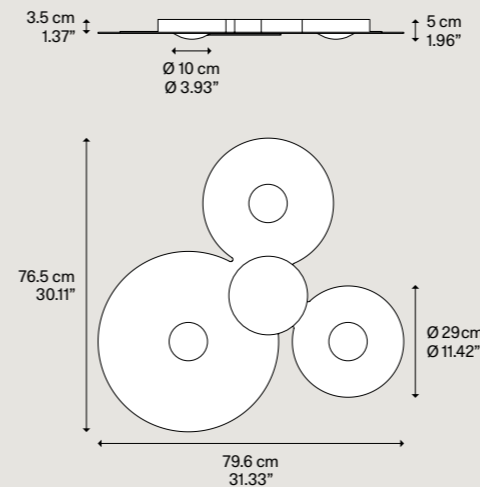

Light source Sorgente luminosa	Metal structure Montatura in metallo	Methacrylate diffuser Diffusore in metacrilato	Code Codice
LED ↗ 2700 K ↗ 3 x 15 W/3735 lm ↗ 220-240 V ↗ CRI 90 ↗ MacAdam 3-Step	<input type="radio"/> Matte White - 9010 Bianco Opaco - 9010	<input type="radio"/> Glossy White Bianco Lucido	16134 1227
		<input type="radio"/> Glossy Black Nero Lucido	16134 2227
		<input type="radio"/> Chrome Cromo	16134 4027
		<input type="radio"/> Glossy Bronze Bronzo Lucido	16134 4627
		<input type="radio"/> Gold Oro	16134 5027
LED included LED incluso	<input type="radio"/> Matte White - 9010 Bianco Opaco - 9010	<input type="radio"/> Glossy White Bianco Lucido	16134 1230
		<input type="radio"/> Glossy Black Nero Lucido	16134 2230
		<input type="radio"/> Chrome Cromo	16134 4030
		<input type="radio"/> Glossy Bronze Bronzo Lucido	16134 4630
		<input type="radio"/> Gold Oro	16134 5020

Net weight/Peso netto: 4.4 kg

Pack/Colli: 2

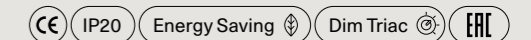

LED sources with direct power supply to the AC line voltage - driver not required. Dimmable with phase cut dimmer.

LED con alimentazione diretta a tensione di rete - non necessita di driver. Dimmerabile con varialuce a taglio di fase.

Pin-Up

A striking, compact light with a simple, organic design, Pin-Up opens like a shell to provide a bright light and the quality of LED lighting. A light that can be modelled at will thanks to the flexibility of the light fixture and the availability of two LED sources.

Una lampada compatta e sorprendente, dal design essenziale ed organico, Pin-Up si schiude come una conchiglia per illuminare gli spazi con la decisione e la qualità della luce a LED. Una luce che può essere modellata a piacere grazie alla flessibilità della lampada e alla disponibilità di due sorgenti LED.

Wall lamp, Ceiling lamp

Pin-Up,
FINISH Matte Black

Pin-Up, *design by* Andrea Tosetto, 2015





Pin-Up, FINISH Matte White



Pin-Up, FINISH Coppery Bronze

Lampe compacte et surprenante, au design essentiel et organique, Pin-Up s'ouvre comme une coquille pour éclairer les espaces avec la précision et la qualité de la lumière LED. Une lumière qui peut être modelée à souhait grâce à la flexibilité de la lampe et à la disponibilité de deux sources LED. ●FR

Als eine kompakte und überraschende Lampe mit klarem, organischem Design schließt sich Pin-Up wie eine Muschel, um Räume mit der Entschlossenheit und Qualität von LED-Licht zu erhellen. Ein Licht, das dank der Flexibilität der Lampe und des Vorhandenseins von zwei LED-Quellen verändert werden kann. ●DE

Una lámpara compacta y sorprendente, de diseño esencial y orgánico, Pin-Up se abre como una concha para iluminar los espacios con la decisión y la calidad de la luz de LED. Una luz que puede ser modelada a gusto gracias a la flexibilidad de la lámpara y a la disponibilidad de dos fuentes de LED. ●ES

Pin-Up – изумительный компактный светильник со сдержанным, органичным дизайном. Открывается как ракушка и смело освещает пространство качественным светодиодным светом. Превосходная гибкость и наличие двух светодиодных источников позволяют моделировать освещение по желанию. ●RU

Pin-Up是一款紧凑而令人惊喜的灯具，设计简洁有序，如一个贝壳打开，以坚定而优质的LED灯光照亮空间。灯身灵活，配有两盏LED光源，灯光可随喜好调节。●ZH

Visit website:



Pin-Up, design by Andrea Tosetto, 2015

Wall lamp

Ceiling lamp

Pin-Up

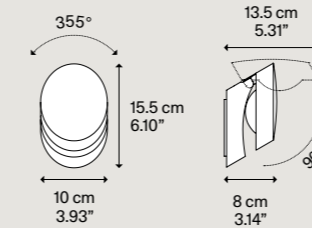

Light source
Sorgente luminosa

LED
 ↘ 2700 K
 ↘ 8 W/920 lm
 ↘ 220-240 V
 ↘ CRI 92
 ↘ MacAdam 3-Step

or

LED
 ↘ 3000 K
 ↘ 8 W/980 lm
 ↘ 220-240 V
 ↘ CRI 92
 ↘ MacAdam 3-Step

LED included
LED incluso

Metal structure
Montatura in metallo

● Matte White – 9010
Bianco Opaco – 9010

Code
Codice

15540 1027

● Matte Black – 9005
Nero Opaco – 9005

15540 2027

● Coppery Bronze
Bronzo Ramato

15540 3527

● Matte White – 9010
Bianco Opaco – 9010

15540 1030

● Matte Black – 9005
Nero Opaco – 9005

15540 2030

● Coppery Bronze
Bronzo Ramato

15540 3530



Adjustable light
Luce orientabile

Net weight/Peso netto: 1.15 kg

Pack/Colli: 1

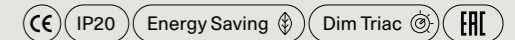

Pin-Up ↘ Wall lamp, Ceiling lamp

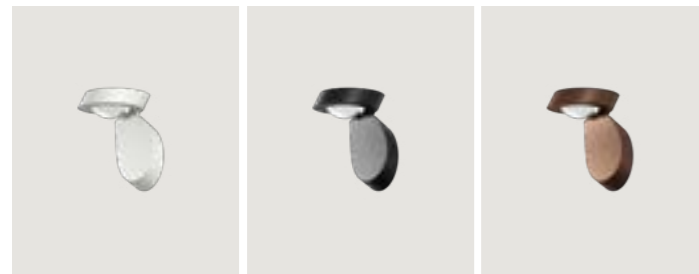

Laser

Laser is a compact, versatile light fixture in the shape of a box with an attractive architectural look. From its painted steel structure, available in one size and three different finishes, now including Champagne, the LED light source diffuses a functional and evocative two-way light that creates plays of light and shadow on the wall.

Laser è una lampada compatta a forma di parallelepipedo dal carattere versatile e architettonico. Dalla sua struttura in acciaio verniciato, disponibile in una dimensione e in tre diverse finiture, ora anche Champagne, la sorgente a LED diffonde una luce bidirezionale funzionale e d'effetto che crea giochi di luce ed ombra sulla parete.

Wall lamp

Laser 10 × 10,
FINISH Matte Black

Laser, *design by* Studio Italia Design, 2015





Laser 10 × 10, FINISH Matte White

Laser 10 × 10,
FINISH Champagne

Laser est une lampe compacte en forme de parallélépipède au caractère polyvalent et architectural. De sa structure en acier peint, disponible en taille unique et en trois finitions différentes, y compris le Champagne, la source LED diffuse une lumière bidirectionnelle fonctionnelle et efficace qui crée des jeux d'ombre et de lumière sur le mur. ●FR

Laser ist eine kompakte Lampe in Form eines Parallelepipedes mit vielseitigem und architektonischem Charakter. Durch seine Armatur aus lackiertem Stahl, die in einer Größen und drei unterschiedlichen Ausführungen - jetzt auch Champagner - verfügbar ist, verbreitet die LED-Lichtquelle bidirektionales, funktionelles sowie effektvolles Licht, wodurch ein Spiel aus Licht und Schatten an der Wand entsteht. ●DE

Laser es una lámpara compacta con forma de paralelepípedo con carácter versátil y arquitectónico. De su estructura de acero pintado, disponible en una dimensión y en tres diferentes acabados, ahora incluyendo Champán, la fuente de LED difunde una luz bidireccional funcional y con efecto que crea juegos de luz y sombra en la pared. ●ES

Laser – компактный светильник в форме параллелепипеда с многогранным архитектурным характером. Конструкция светильника выполнена из окрашенной стали, доступной в двух размерах и трех различных вариантах отделки. Светодиодный источник эффективно рассеивает двунаправленный свет, создающий на стене игру света и тени. ●RU

Laser是一款四边形的紧凑灯具，具有建筑美感，广泛适用。喷漆钢材的结构，有一种尺寸和三种不同的颜色，如今还有香槟色，LED光源散发着双向的功能灯光，在墙壁上形成光影效果。●ZH

Visit website:



Laser, design by Studio Italia Design, 2015

Wall lamp

Laser 10 × 10 LED

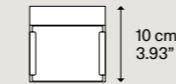
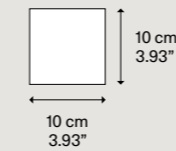

Light source
Sorgente luminosa

LED
↘ 2700 K
↘ 15 W/1750 lm
↘ 220-240 V
↘ CRI 92
↘ MacAdam 3-Step

or

LED
↘ 3000 K
↘ 15 W/1850 lm
↘ 220-240 V
↘ CRI 92
↘ MacAdam 3-Step

LED included
LED incluso

Metal structure
Montatura in metallo

● Matte White – 9010
Bianco Opaco – 9010

● Matte Black – 9005
Nero Opaco – 9005

● Champagne ^{NEW}
Champagne

● Matte White – 9010
Bianco Opaco – 9010

● Matte Black – 9005
Nero Opaco – 9005

● Champagne ^{NEW}
Champagne

Code
Codice

03652 1027

03652 2027

03652 4527

03652 1030

03652 2030

03652 4530

Net weight/Peso netto: 0.6 kg

Pack/Colli: 1

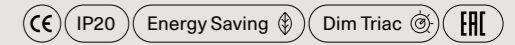

Laser 10 × 10 ↘ Wall lamp

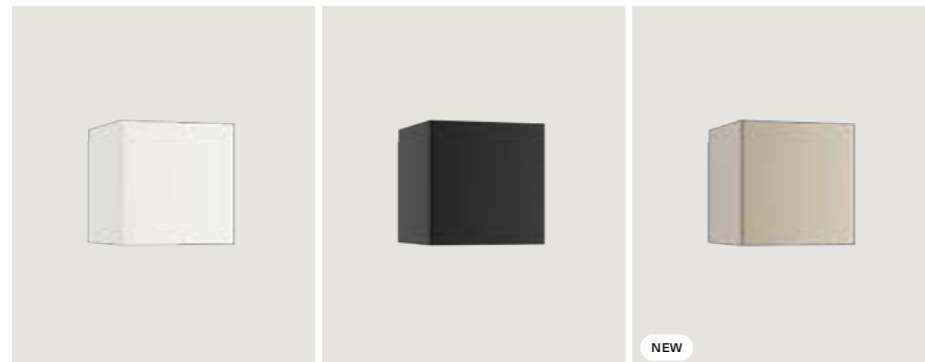

Make-Up

Make-Up's design is inspired by fashion and beauty. A versatile blown glass lamp with a gentle shape, Make-Up dresses walls and ceilings with light. Elegantly functional when used individually, it acquires a highly decorative appeal in lively compositions of different sizes and volumes.

Il design di Make-Up si ispira alla moda e alla bellezza. Lampada versatile in vetro soffiato dalla forma morbida, Make-Up veste di luce la parete e il soffitto. Elegantemente funzionale se usata singolarmente, acquista valore fortemente decorativo nelle vivaci composizioni di dimensioni e volumi diversi.

Wall lamp, Ceiling lamp

Make-Up,
FINISH Frosted White

Make-Up, *design by* Studio Italia Design, 2015



Make-Up small, medium and large,
FINISH Frosted White



Le design de Make-Up est inspiré par la mode et la beauté. Lampe polyvalente en verre soufflé de forme délicate, Make-Up habille de lumière les murs et le plafond. Élégamment fonctionnel en usage individuel, elle acquiert une grande valeur décorative dans des compositions dynamiques de tailles et de volumes différents. ●FR

Das Design von Make-Up ist von Mode und Schönheit inspiriert. Als vielseitige Lampe aus geblasenem Glas mit ihrer weichen Form kleidet Make-Up Wand und Decke mit Licht. Bei einzelner Verwendung ist sie elegant und funktionell, als lebhaft Kombination aus verschiedenen Größen und Volumen wird sie hingegen zu einem besonderen Dekorationselement. ●DE

El diseño de Make-Up está inspirado en la moda y la belleza. Una versátil lámpara de vidrio soplado de forma delicada, Make-Up viste de luz la pared y el techo. Elegantemente funcional cuando se usa individualmente, adquiere un alto valor decorativo en composiciones llamativas de diferentes tamaños y volúmenes. ●ES

Дизайн Make-Up навеян модой и красотой. Модульный светильник из выдувного стекла мягкой формы может украсить своим светом как стену, так и потолок. Элегантен и эффективен даже по отдельности, а в составных композициях различных размеров и объемов приобретает еще большую декоративную ценность. ●RU

Make-Up设计灵感来自时尚与美。组合式吹制玻璃吊灯外形柔和，为墙壁或天花板增添光彩。优雅实用，单独使用具有强烈的装饰性，可组成各种尺寸和体积的活泼组合。●ZH

Visit website:



Make-Up small ↘ Wall lamp Make-Up medium ↘ Wall lamp Make-Up large ↘ Wall lamp

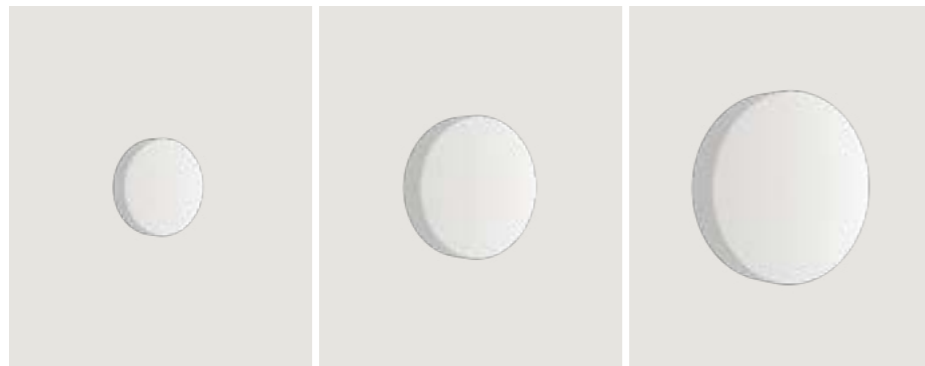

Make-Up small ↘ Ceiling lamp Make-Up medium ↘ Ceiling lamp Make-Up large ↘ Ceiling lamp

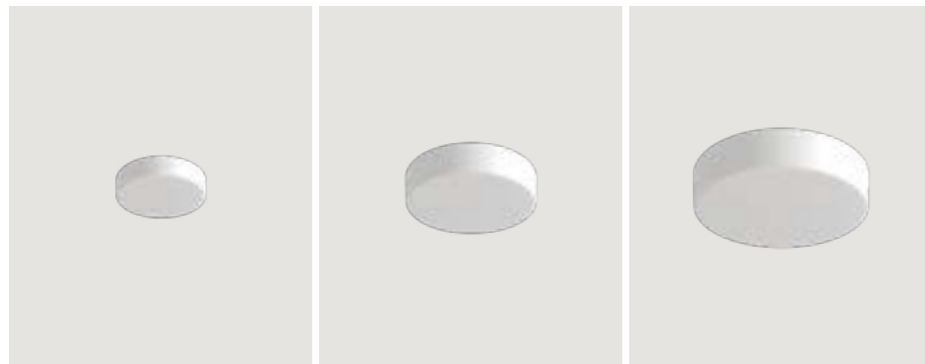

Make-Up, design by Studio Italia Design, 2015

Wall lamp

Ceiling lamp

Make-Up small

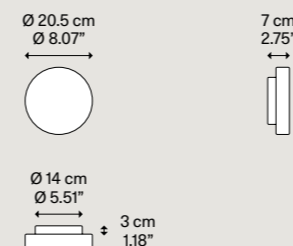

Light source
Sorgente luminosa

LED
↘ 3000 K
↘ 8 W/980 lm
↘ 220-240 V
↘ CRI 92
↘ MacAdam 3-Step

LED included
LED incluso

Metal structure
Montatura in metallo

● Matte White - 9016
● Bianco Opaco - 9016

Blown glass diffuser
Diffusore in vetro soffiato

● Frosted White
● Bianco Satinato

Code
Codice

15041 30

Net weight/Peso netto: 1.3 kg

Pack/Colli: 1

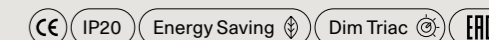

Make-Up medium

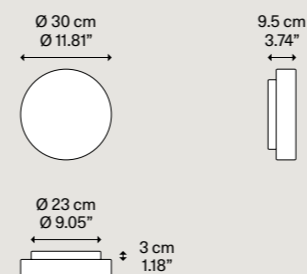

LED
↘ 3000 K
↘ 15 W/1850 lm
↘ 220-240 V
↘ CRI 92
↘ MacAdam 3-Step

LED included
LED incluso

● Matte White - 9016
● Bianco Opaco - 9016

● Frosted White
● Bianco Satinato

15042 30

Net weight/Peso netto: 2.32 kg

Pack/Colli: 1

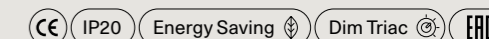

Make-Up large

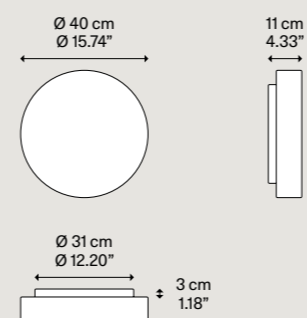

LED
↘ 3000 K
↘ 15 W/1850 lm
↘ 220-240 V
↘ CRI 92
↘ MacAdam 3-Step

LED included
LED incluso

● Matte White - 9016
● Bianco Opaco - 9016

● Frosted White
● Bianco Satinato

15043 30

Net weight/Peso netto: 3.88 kg

Pack/Colli: 1

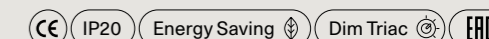

► LED sources with direct power supply to the AC line voltage - driver not required. Dimmable with phase cut dimmer. ► You can connect up to 3 Make-Up to each fixture directly connected to the power supply. You can also connect up to 2 additional fixtures to each of those for maximum total of 50 fixtures on a single power outlet.

► LED con alimentazione diretta a tensione di rete - non necessita di driver. Dimmerabile con varialuce a taglio di fase. ► Ad ogni Make-Up connessa al punto di alimentazione elettrica possono esserne collegate altre 3. Ad ognuna di queste possono esserne collegate fino a 2 e così via. Le lampade totali collegabili su un singolo punto di alimentazione sono 50.

Frozen

Frozen is a lamp with a minimalist design that seems to blend in with the ceiling. From the thin painted steel frame, crystal lenses set like gems diffuse a harmonious direct light that gives life to the environment.

Frozen è una lampada dal design minimalista che sembra aderire al soffitto. Dalla sottile montatura in acciaio verniciato, lenti in cristallo incastonate come gemme diffondono un'armoniosa luce diretta che dà vita all'ambiente.

Ceiling lamp

Frozen medium,
FINISH Coppery Bronze

Frozen, *design by* Studio Italia Design, 2015





Frozen medium, FINISH Coppery Bronze

Frozen small,
FINISH Matte White

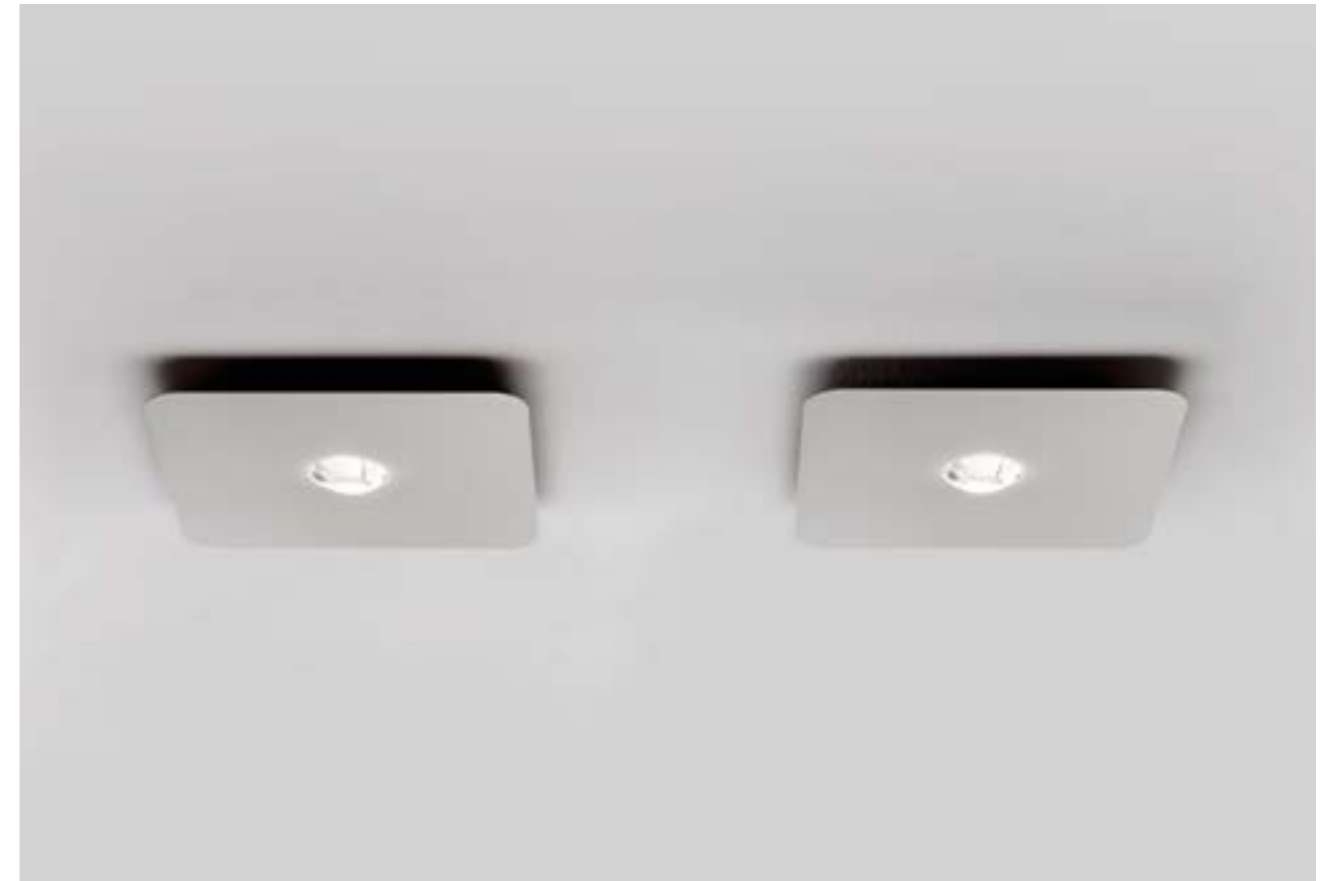

Frozen est une lampe au design minimaliste qui semble adhérer au plafond. De la fine armature en acier peint, ses verres de cristal sertis comme des pierres précieuses diffusent une lumière directe harmonieuse qui donne vie à l'environnement. ●FR

Frozen ist eine Leuchte mit minimalistischem Design, die an der Decke zu haften scheint. Aus dem dünnen, lackierten Stahlrahmen streuen wie Edelsteine gefasste Kristalllinsen ein harmonisches, direktes Licht, das der Umgebung Leben einhaucht. ●DE

Frozen es una lámpara de diseño minimalista que parece adherirse al techo. Con un cuerpo delgado de acero pintado, lentes de cristal incrustado como gemas difunden una luz armónica directa que da vida al ambiente. ●ES

Frozen – это светильник в минималистичном стиле, который как будто прилип к потолку. Имеет тонкое основание из окрашенной стали и хрустальные линзы, которые, словно драгоценные камни в оправе, распространяют гармоничный прямой свет, наполняющий жизнью окружающее пространство. ●RU

Frozen是一盏极简设计的灯，似乎贴在天花板上。纤细的喷漆钢质结构，镶嵌水晶镜片如同一块宝石，散发着和谐的直接光线，为环境赋予生气。●ZH

Visit website:



Frozen small › Ceiling lamp

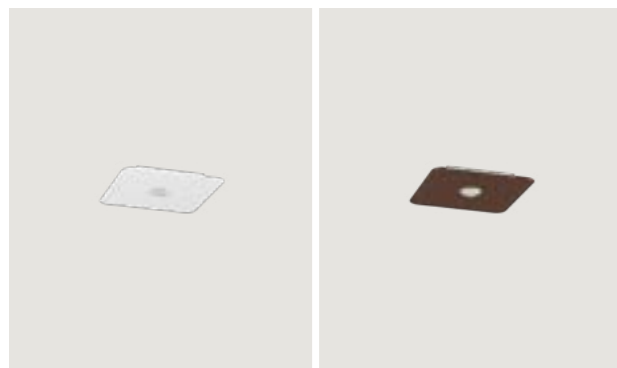

Frozen medium › Ceiling lamp

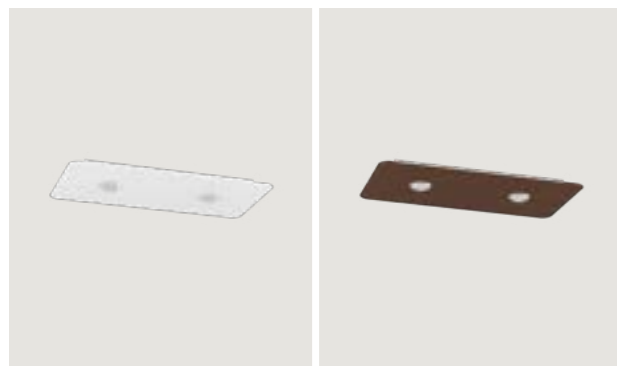

Frozen, design by Studio Italia Design, 2015

Ceiling lamp

Frozen small

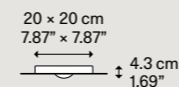
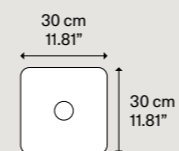

Net weight/Peso netto: 1.77 kg

Pack/Colli: 1

Light source

Sorgente luminosa

LED
 › 2700 K
 › 15 W/1245 lm
 › 220-240 V
 › CRI 90
 › MacAdam 3-Step

or

LED
 › 3000 K
 › 15 W/1355 lm
 › 220-240 V
 › CRI 90
 › MacAdam 3-Step

LED included
 LED incluso

Metal structure

Montatura in metallo

● Matte White – 9010
 Bianco Opaco – 9010

● Coppery Bronze
 Bronzo Ramato

Code

Codice

14931 1027

14931 3527

14931 1030

14931 3530

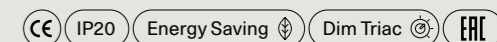

Frozen medium

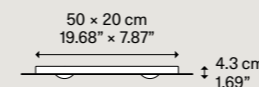
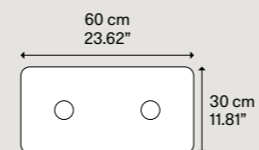

Net weight/Peso netto: 3.27 kg

Pack/Colli: 1

LED
 › 2700 K
 › 2 x 15 W/2490 lm
 › 220-240 V
 › CRI 90
 › MacAdam 3-Step

or

LED
 › 3000 K
 › 2 x 15 W/2710 lm
 › 220-240 V
 › CRI 90
 › MacAdam 3-Step

LED included
 LED incluso

● Matte White – 9010
 Bianco Opaco – 9010

● Coppery Bronze
 Bronzo Ramato

14932 1027

14932 3527

14932 1030

14932 3530

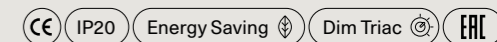

Canopies

A Single Canopy

Single canopies are ideal for highlighting the corner of a room or enhancing single light sources. They can also be used to create multiple custom combinations on high ceilings or in situations which do not allow lights to be grouped in a cluster.

D Round and Rectangular Cluster Systems

Our multiple canopies, round or rectangular, are functional systems to create suspended compositions with a variable but predefined number of holes.

C Radial Systems

Radial systems are an innovative way to separately manage various suspension cables starting from one single canopy—particularly useful to illuminate rooms with irregular ceilings.

D Track Systems

Track systems offers various possibilities of in-line composition with a variable number of lamps depending on the preferred type of installation, i.e. height-aligned or staggered suspensions.

A Rosoni Singoli

I rosoni singoli si prestano ad enfatizzare gli angoli di una stanza o a valorizzare i singoli corpi luce. Possono inoltre essere utilizzati per creare composizioni multiple personalizzate su soffitti molto alti o nelle situazioni che non permettono l'utilizzo di cluster.

C Sistemi Cluster Rotondi e Rettangolari

I nostri rosoni multipli, rotondi o rettangolari, sono sistemi funzionali per creare composizioni sospese con un numero di fori variabile ma predefinito.

D Sistemi Radiali

I sistemi radiali sono un modo innovativo per gestire separatamente diversi cavi di sospensione a partire da un unico rosone – particolarmente utili per illuminare ambienti con soffitti irregolari.

D Sistemi a Binario Lineare

I sistemi a binario offrono varie possibilità di composizione in linea con un numero variabile di lampade a seconda del tipo di installazione desiderato, ossia sospensioni allineate in altezza o sfalsate.

Single canopies

A - Single

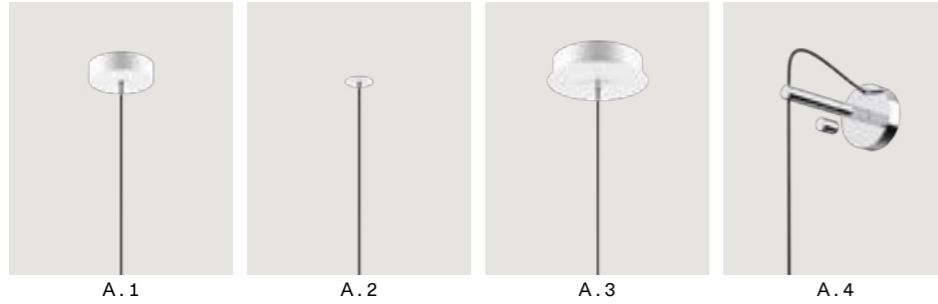

- | | | |
|------|-----------------|-----|
| A. 1 | Single Mini | 397 |
| A. 2 | Recessed Micro | 397 |
| A. 3 | Single Standard | 397 |
| A. 4 | Wall Standard | 397 |

Multiple canopies

B - Round and Rectangular

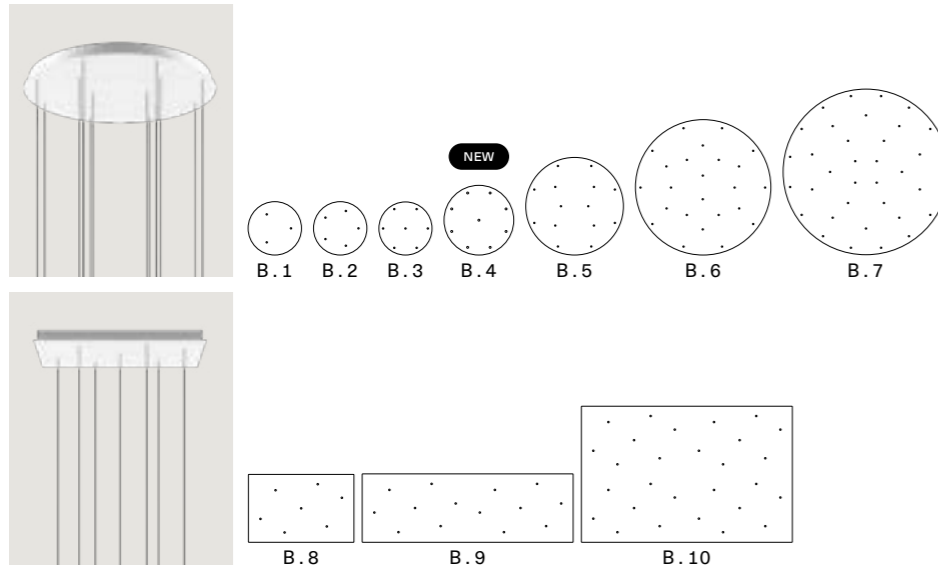

- | | | |
|------|---------------------------|-----|
| B. 1 | 3 Lights Round | 399 |
| B. 2 | 5 Lights Round | 399 |
| B. 3 | 7 Lights Round | 399 |
| B. 4 | 9 Lights Round NEW | 399 |
| B. 5 | 14 Lights Round | 400 |
| B. 6 | 24 Lights Round | 400 |
| B. 7 | 36 Lights Round | 400 |

- | | | |
|-------|-----------------------|-----|
| B. 8 | 7 Lights Rectangular | 401 |
| B. 9 | 14 Lights Rectangular | 401 |
| B. 10 | 28 Lights Rectangular | 401 |

C - Radial

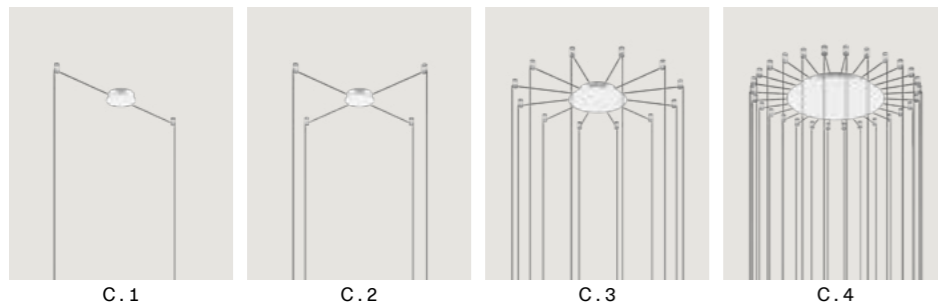

- | | | |
|------|-------------------|-----|
| C. 1 | 1-2 Lights Radial | 404 |
| C. 2 | 4 Lights Radial | 404 |
| C. 3 | 12 Lights Radial | 404 |
| C. 4 | 28 Lights Radial | 405 |

D - Track

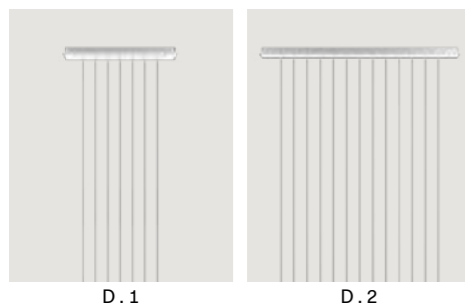

- | | | |
|------|--------------------|-----|
| D. 1 | Short Lights Track | 402 |
| D. 2 | Long Lights Track | 403 |

Cluster suspension lamp

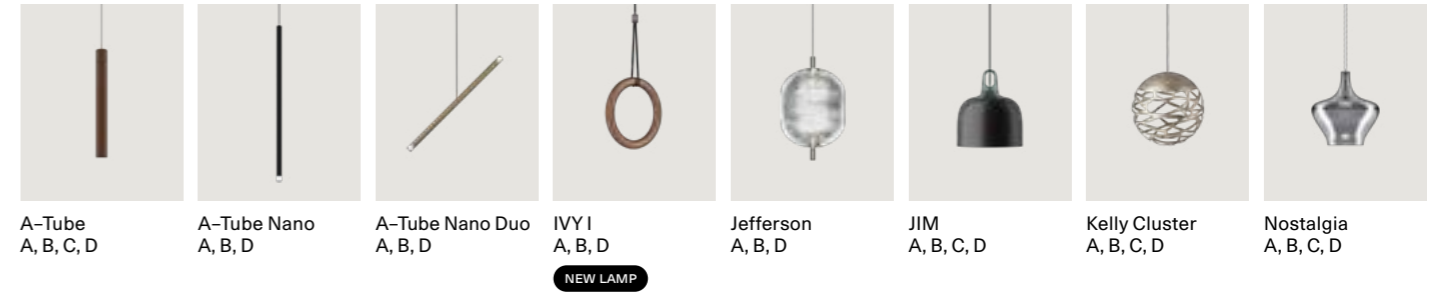

- | | | | | | | | |
|----------------------|------------------------|----------------------------|------------------|----------------------|-------------------|-----------------------------|-------------------------|
| A-Tube
A, B, C, D | A-Tube Nano
A, B, D | A-Tube Nano Duo
A, B, D | IVY I
A, B, D | Jefferson
A, B, D | JIM
A, B, C, D | Kelly Cluster
A, B, C, D | Nostalgia
A, B, C, D |
|----------------------|------------------------|----------------------------|------------------|----------------------|-------------------|-----------------------------|-------------------------|

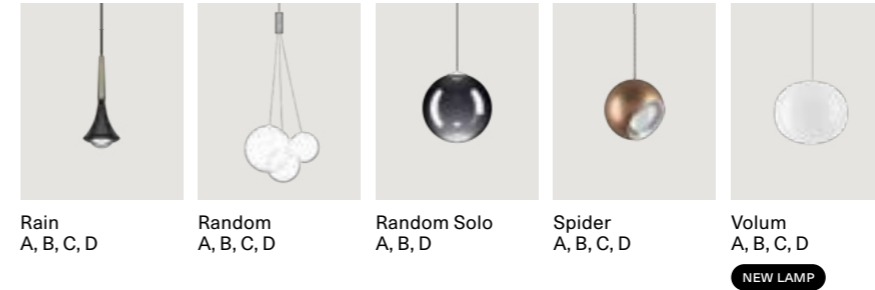

- | | | | | |
|--------------------|----------------------|------------------------|----------------------|---------------------|
| Rain
A, B, C, D | Random
A, B, C, D | Random Solo
A, B, D | Spider
A, B, C, D | Volum
A, B, C, D |
|--------------------|----------------------|------------------------|----------------------|---------------------|

Our canopies are smart functional solutions as well as stand-out decorative elements for suspension lamps or wall fixtures. The variety of our canopy range provides an array of possibilities to personalise any living spaces, whether domestic or public.

I nostri rosoni sono soluzioni funzionali e insieme elementi decorativi differenzianti per lampade a sospensione o a parete. La varietà della nostra gamma di rosoni offre una miriade di possibilità di personalizzazione degli spazi abitativi, domestici e pubblici.

Single canopies

Single Mini

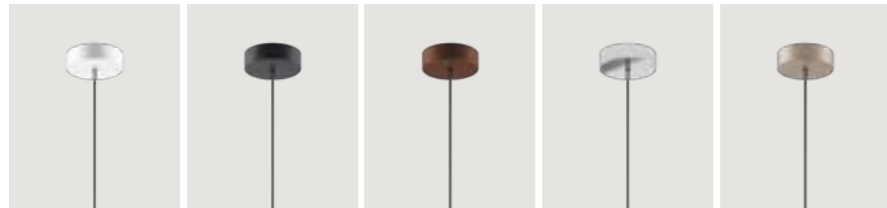

Recessed Micro

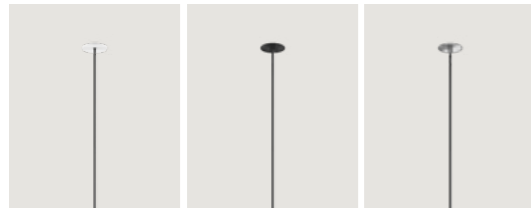

Single Standard



Wall Standard

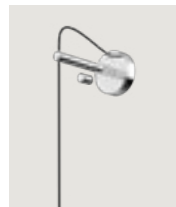

Single Canopy

Single Mini



Ø 8 cm
Ø 3.15"

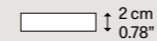

2 cm
0.78"

Net weight/Peso netto: 0.13 kg

Pack/Colli: 1

Recessed Canopy

Recessed Micro



Ø 3.5 cm
Ø 1.37"

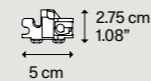

5 cm
1.96"

Min 0.7 cm - 0.27"
Max 2.4 cm - 0.94"

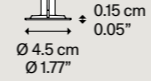

0.15 cm
0.05"

Net weight/Peso netto: 0.025 kg

Pack/Colli: 1

Single Canopy

Single Standard

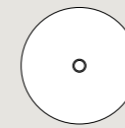

Ø 12.5 cm
Ø 4.92"

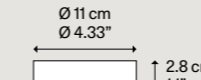

Ø 11 cm
Ø 4.33"

Net weight/Peso netto: 0.4 kg

Pack/Colli: 1

Wall Bracket

Wall Standard



Ø 8 cm
Ø 3.15"



8 cm
3.15"

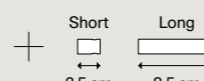

Short
2.5 cm
0.98"

Long
8.5 cm
3.34"

Net weight/Peso netto: 0.8 kg

Pack/Colli: 1

Description

Single ceiling bracket small size

Rosone per lampada singola versione mini

Metal structure

Matte White - 9010
Bianco Opaco - 9010

Matte Black - 9005
Nero Opaco - 9005

Coppery Bronze
Bronzo Ramato

Chrome
Cromo

Matte Champagne
Champagne Opaco

System

Single

Code

R02L01 1000

R02L01 2000

R02L01 3500

R02L01 4000

R02L01 4500



Description

Recessed bracket for single lamp max capacity 3.5 kg

Rosone da incasso per lampada singola portata max 3.5 kg

Methacrylate structure

Matte White - 9010
Bianco Opaco - 9010

Matte Black - 9005
Nero Opaco - 9005

Chrome
Cromo

System

Recessed

Code

R01L01 1000

R01L01 2000

R01L01 4000

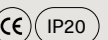

Description

Single ceiling bracket standard size

Rosone per lampada singola versione standard

Metal structure

Matte White - 9010
Bianco Opaco - 9010

System

Single

Code

R03L01 1000



Description

Wall bracket for suspension modular system

Supporto a parete per sistema modulare a sospensione

Metal structure

Chrome
Cromo

System

Wall

Code

R09L01 4000



RECESSED MICRO ► Suitable for ceilings up to 2.4 cm - 0.94" thickness. WALL STANDARD ► Both accessories in the two available lengths are supplied in the box with the wall bracket.

RECESSED MICRO ► Adatta per soffitti fino a 2.4 cm - 0.94" di spessore. WALL STANDARD ► Entrambi gli accessori nelle due diverse lunghezze sono inclusi nella confezione con il supporto a parete.

Multiple canopies

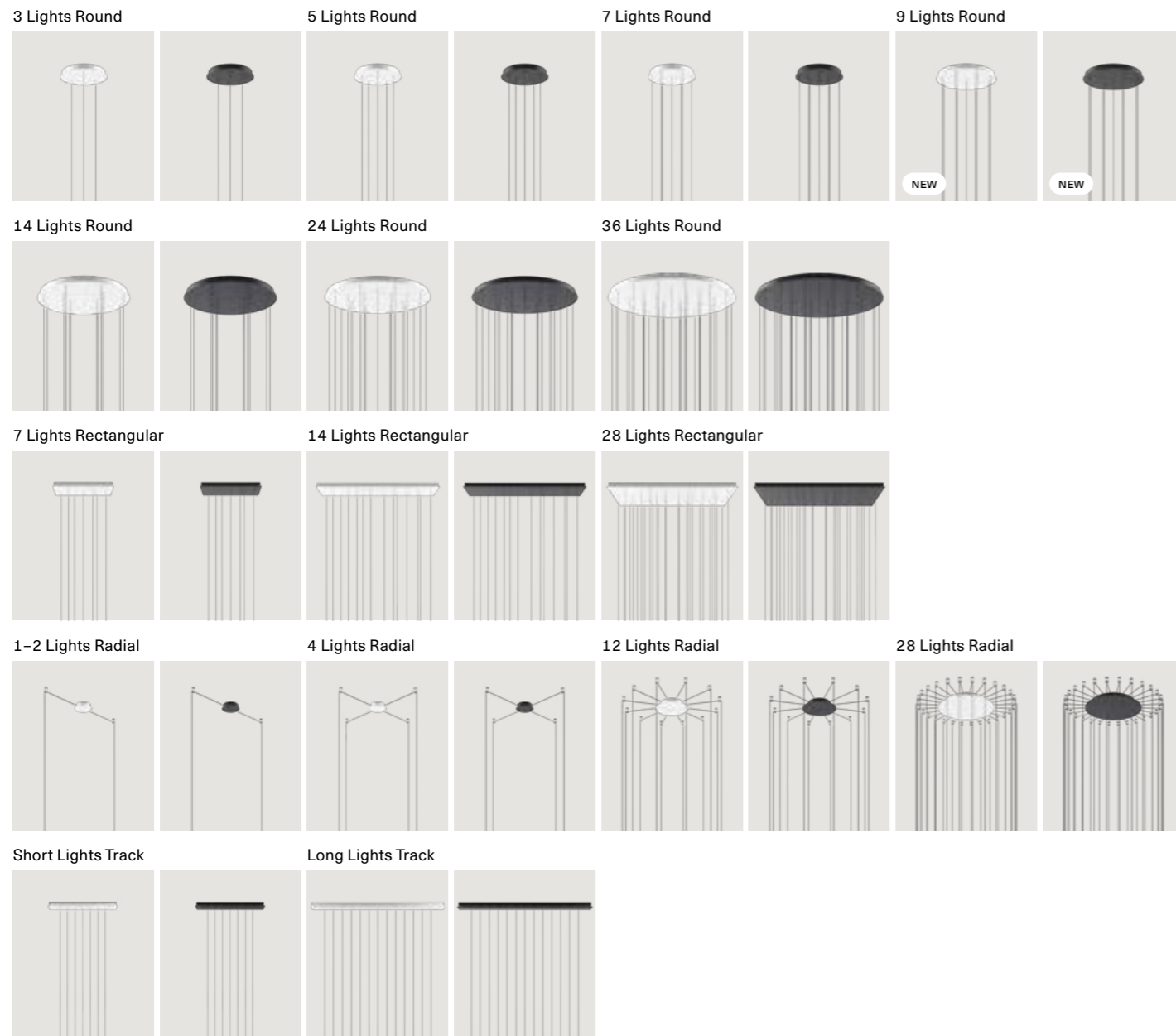

Cluster System

3 Lights Round

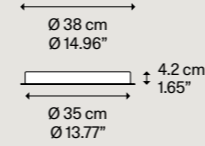
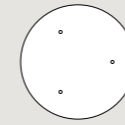

Net weight/Peso netto: 3.55 kg Pack/Colli: 1

Description Descrizione

Round canopy
for 3 suspensions

Rosone circolare
per 3 sospensioni

Metal structure Struttura in metallo

● Matte White - 9010
Bianco Opaco - 9010

● Matte Black - 9005
Nero Opaco - 9005

System Sistema

Cluster

Code Codice

R04L03 1000

R04L03 2000



5 Lights Round

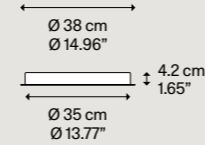
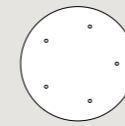

Net weight/Peso netto: 3.55 kg Pack/Colli: 1

Round canopy
for 5 suspensions

Rosone circolare
per 5 sospensioni

● Matte White - 9010
Bianco Opaco - 9010

● Matte Black - 9005
Nero Opaco - 9005

Cluster

R04L05 1000

R04L05 2000



7 Lights Round

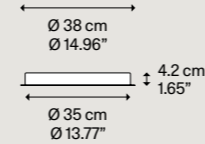
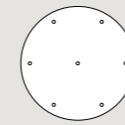

Net weight/Peso netto: 3.55 kg Pack/Colli: 1

Round canopy
for 7 suspensions

Rosone circolare
per 7 sospensioni

● Matte White - 9010
Bianco Opaco - 9010

● Matte Black - 9005
Nero Opaco - 9005

Cluster

R04L07 1000

R04L07 2000



9 Lights Round ^{NEW}

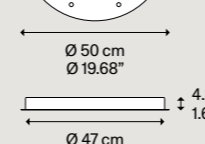
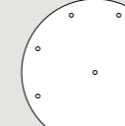

Net weight/Peso netto: 5.80 kg Pack/Colli: 1

Round canopy
for 9 suspensions

Rosone circolare
per 9 sospensioni

● Matte White - 9010
Bianco Opaco - 9010

● Matte Black - 9005
Nero Opaco - 9005

Cluster

R04L09 1000

R04L09 2000

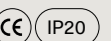

Cluster System

14 Lights Round

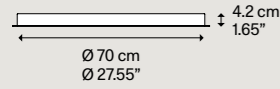
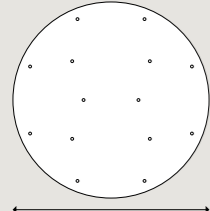

Net weight/Peso netto: 14.14 kg Pack/Colli: 1

Description Descrizione	Metal structure Struttura in metallo	System Sistema	Code Codice
Round canopy for 14 suspensions	● Matte White – 9010 Bianco Opaco – 9010	Cluster	R04L14 1000
Rosone circolare per 14 sospensioni	● Matte Black – 9005 Nero Opaco – 9005		R04L14 2000

CE IP20

24 Lights Round

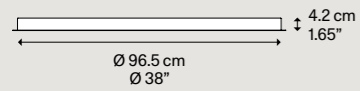
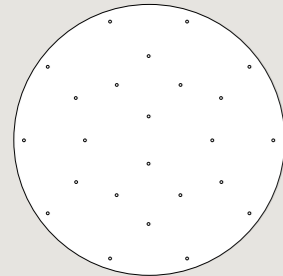

Net weight/Peso netto: 23.5 kg Pack/Colli: 1

Description Descrizione	Metal structure Struttura in metallo	System Sistema	Code Codice
Round canopy for 24 suspensions	● Matte White – 9010 Bianco Opaco – 9010	Cluster	R04L24 1000
Rosone circolare per 24 sospensioni	● Matte Black – 9005 Nero Opaco – 9005		R04L24 2000

CE IP20

36 Lights Round

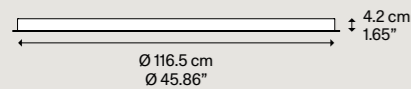
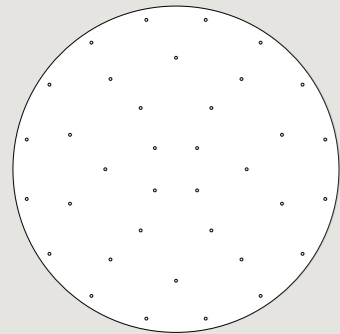

Net weight/Peso netto: 32.7 kg Pack/Colli: 1

Description Descrizione	Metal structure Struttura in metallo	System Sistema	Code Codice
Round canopy for 36 suspensions	● Matte White – 9010 Bianco Opaco – 9010	Cluster	R04L36 1000
Rosone circolare per 36 sospensioni	● Matte Black – 9005 Nero Opaco – 9005		R04L36 2000

CE IP20

Cluster System

7 Lights Rectangular

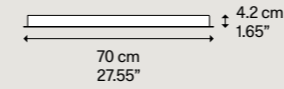
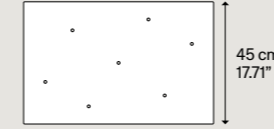

Net weight/Peso netto: 9.89 kg Pack/Colli: 1

Description Descrizione	Metal structure Struttura in metallo	System Sistema	Code Codice
Rectangular canopy for 7 suspensions	● Matte White – 9010 Bianco Opaco – 9010	Cluster	R05L07 1000
Rosone rettangolare per 7 sospensioni	● Matte Black – 9005 Nero Opaco – 9005		R05L07 2000

CE IP20

14 Lights Rectangular

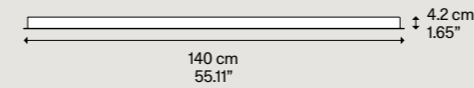
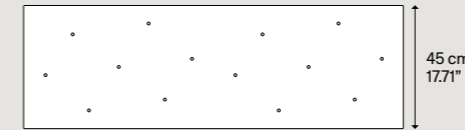

Net weight/Peso netto: 17.1 kg Pack/Colli: 1

Description Descrizione	Metal structure Struttura in metallo	System Sistema	Code Codice
Rectangular canopy for 14 suspensions	● Matte White – 9010 Bianco Opaco – 9010	Cluster	R05L14 1000
Rosone rettangolare per 14 sospensioni	● Matte Black – 9005 Nero Opaco – 9005		R05L14 2000

CE IP20

28 Lights Rectangular

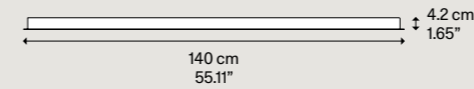
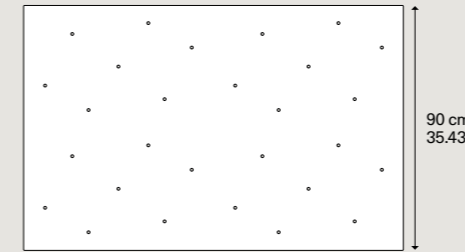

Net weight/Peso netto: 31.1 kg Pack/Colli: 1

Description Descrizione	Metal structure Struttura in metallo	System Sistema	Code Codice
Rectangular canopy for 28 suspensions	● Matte White – 9010 Bianco Opaco – 9010	Cluster	R05L28 1000
Rosone rettangolare per 28 sospensioni	● Matte Black – 9005 Nero Opaco – 9005		R05L28 2000

CE IP20

Track System

Short Lights Track

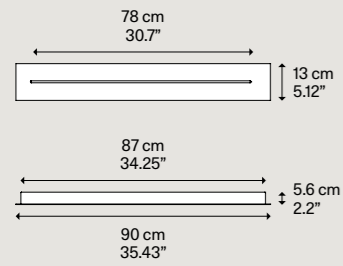

Description Descrizione	Structure finish Finitura struttura	System Sistema	Code Codice
Multiple linear track standard version max 7 suspensions	● Matte White – 9010 Bianco Opaco – 9010	Track	R08L98 1000
	● Matte Black – 9005 Nero Opaco – 9005		R08L98 2000
Binario lineare multiplo versione standard max 7 sospensioni			

Net weight/Peso netto: 5.5 kg

Pack/Colli: 1



Track System

Long Lights Track

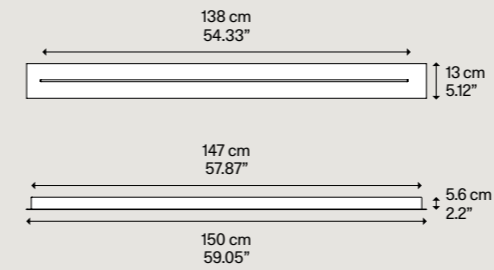

Description Descrizione	Structure finish Finitura struttura	System Sistema	Code Codice
Multiple linear track standard version max 11 suspensions	● Matte White – 9010 Bianco Opaco – 9010	Track	R08L99 1000
	● Matte Black – 9005 Nero Opaco – 9005		R08L99 2000
Binario lineare multiplo versione standard max 11 sospensioni			

Net weight/Peso netto: 8.8 kg

Pack/Colli: 1



Short Lights Track





Maximum quantity Quantità massima		Maximum quantity Quantità massima	
Suspension aligned Sospensione allineata		Staggered suspension Sospensione sfalsata	
Max 7	mod. A–Tube	Max 7	mod. A–Tube
Max 6	mod. A–Tube Nano	Max 6	mod. A–Tube Nano
Max 6	mod. A–Tube Nano Duo	Max 6	mod. A–Tube Nano Duo
Max 6	mod. IVY I	Max 7	mod. IVY I
Max 5	mod. Jefferson	Max 6	mod. Jefferson
Max 4	mod. JIM cylinder	Max 7	mod. JIM cylinder
Max 3	mod. JIM cone	Max 5	mod. JIM cone
Max 3	mod. JIM bell	Max 5	mod. JIM bell
Max 4	mod. Kelly Cluster	Max 7	mod. Kelly Cluster
Max 7	mod. Nostalgia small	Max 7	mod. Nostalgia small
Max 4	mod. Nostalgia medium	Max 7	mod. Nostalgia medium
Max 3	mod. Nostalgia large	Max 5	mod. Nostalgia large
Max 7	mod. Rain	Max 7	mod. Rain
Max 3	mod. Random	Max 5	mod. Random
Max 7	mod. Random Solo 12	Max 7	mod. Random Solo 12
Max 6	mod. Random Solo 14	Max 7	mod. Random Solo 14
Max 4	mod. Random Solo 18	Max 7	mod. Random Solo 18
Max 4	mod. Random Solo 23	Max 7	mod. Random Solo 23
Max 3	mod. Random Solo 28	Max 6	mod. Random Solo 28
Max 7	mod. Spider	Max 7	mod. Spider
Max 6	mod. Volum 14	Max 7	mod. Volum 14
Max 4	mod. Volum 22	Max 7	mod. Volum 22
Max 3	mod. Volum 29	Max 5	mod. Volum 29

Long Lights Track





Maximum quantity Quantità massima		Maximum quantity Quantità massima	
Suspension aligned Sospensione allineata		Staggered suspension Sospensione sfalsata	
Max 11	mod. A–Tube	Max 11	mod. A–Tube
Max 10	mod. A–Tube Nano	Max 10	mod. A–Tube Nano
Max 10	mod. A–Tube Nano Duo	Max 10	mod. A–Tube Nano Duo
Max 10	mod. IVY I	Max 11	mod. IVY I
Max 8	mod. Jefferson	Max 10	mod. Jefferson
Max 8	mod. JIM cylinder	Max 11	mod. JIM cylinder
Max 5	mod. JIM cone	Max 9	mod. JIM cone
Max 5	mod. JIM bell	Max 9	mod. JIM bell
Max 8	mod. Kelly Cluster	Max 11	mod. Kelly Cluster
Max 11	mod. Nostalgia small	Max 11	mod. Nostalgia small
Max 7	mod. Nostalgia medium	Max 11	mod. Nostalgia medium
Max 5	mod. Nostalgia large	Max 9	mod. Nostalgia large
Max 11	mod. Rain	Max 11	mod. Rain
Max 5	mod. Random	Max 9	mod. Random
Max 11	mod. Random Solo 12	Max 11	mod. Random Solo 12
Max 10	mod. Random Solo 14	Max 11	mod. Random Solo 14
Max 8	mod. Random Solo 18	Max 11	mod. Random Solo 18
Max 6	mod. Random Solo 23	Max 11	mod. Random Solo 23
Max 6	mod. Random Solo 28	Max 10	mod. Random Solo 28
Max 11	mod. Spider	Max 11	mod. Spider
Max 10	mod. Volum 14	Max 11	mod. Volum 14
Max 7	mod. Volum 22	Max 11	mod. Volum 22
Max 5	mod. Volum 29	Max 9	mod. Volum 29

Radial System





1–2 Lights Radial

Description Descrizione	Metal structure Struttura in metallo	System Sistema	Code Codice
Ceiling bracket for single decentralized suspension or double opposed	 Matte White – 9010 Bianco Opaco – 9010	Radial	R06L02 1000
	 Matte Black – 9005 Nero Opaco – 9005		R06L02 2000
Rosone circolare per sospensione singola decentrata o doppia contrapposta			
Radial Swag Kit not included			
Radial Swag Kit non incluso			
			 
Net weight/Peso netto: 0.35 kg		Pack/Colli: 1	

4 Lights Radial

Radial canopy max 4 suspensions	 Matte White – 9010 Bianco Opaco – 9010	Radial	R06L04 1000
	 Matte Black – 9005 Nero Opaco – 9005		R06L04 2000
Rosone radiale max 4 sospensioni			
Radial Swag Kit not included			
Radial Swag Kit non incluso			
			 
Net weight/Peso netto: 0.35 kg		Pack/Colli: 1	

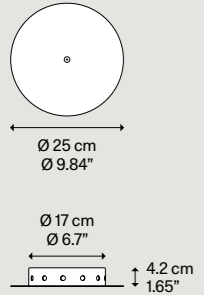
12 Lights Radial





Radial canopy max 12 suspension	 Matte White – 9010 Bianco Opaco – 9010	Radial	R06L12 1000
	 Matte Black – 9005 Nero Opaco – 9005		R06L12 2000
Rosone radiale max 12 sospensioni			
Radial Swag Kit not included			
Radial Swag Kit non incluso			
			 
Net weight/Peso netto: 1.05 kg		Pack/Colli: 1	

The A–Tube Nano (pag. 060), A–Tube Nano Duo (pag. 073), IVY I (pag. 041), Jefferson (pag. 213) and Random Solo (pag. 201) suspensions can not be installed on the Radial Canopies.

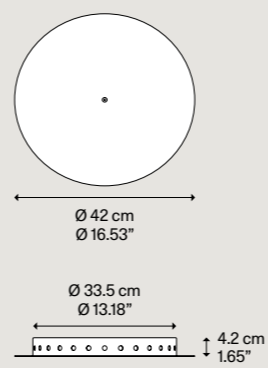

Le sospensioni A–Tube Nano (pag. 060), A–Tube Nano Duo (pag. 073), IVY I (pag. 041), Jefferson (pag. 213) e Random Solo (pag. 201) non possono essere installati nel Sistema Radiale.

Radial System

28 Lights Radial

Description Descrizione	Metal structure Struttura in metallo	System Sistema	Code Codice
Radial canopy max 28 suspension	 Matte White – 9010 Bianco Opaco – 9010	Radial	R06L28 1000
Rosone radiale max 28 sospensioni	 Matte Black – 9005 Nero Opaco – 9005		R06L28 2000
Radial Swag Kit not included			
Radial Swag Kit non incluso			
			 
Net weight/Peso netto: 3.35 kg		Pack/Colli: 1	

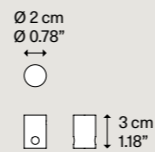
Swag Kit for Radial Canopy

Description Descrizione	Polycarbonate structure Struttura in policarbonato	System Sistema	Code Codice
Wall and ceiling anchor for Radial System power cable max Ø 7 mm – 0.27" max capacity 5 kg	 Clear Trasparente	Radial	999A4 00
Cilindro di decentramento per Sistema Radiale cavo elettrico max Ø 7 mm – 0.27" Portata max 5 kg			
			
Net weight/Peso netto: 0.02 kg		Pack/Colli: 1	

The A–Tube Nano (pag. 060), A–Tube Nano Duo (pag. 073), IVY I (pag. 041), Jefferson (pag. 213) and Random Solo (pag. 201) suspensions can not be installed on the Radial Canopies.

Le sospensioni A–Tube Nano (pag. 060), A–Tube Nano Duo (pag. 073), IVY I (pag. 041), Jefferson (pag. 213) e Random Solo (pag. 201) non possono essere installati nel Sistema Radiale.

Finishes

A Foundational	408	Clear, White, Black, Grey
B Precious	409	Gold, Silver, Palladium
C Warm	410	Bronze, Terra, Honey
D Trend	411	Green, Red, Yellow
E Pastels, Revisited	411	Turquoise, Taupe, Pink

Colours, materials, and finishes enhance the versatile and eclectic character of the brand. From timeless to bolder tones, Lodes finishes make the lamps dialogue with one another while allowing to express different décor moods. The broad range of finished coupled with the flexibility offered by Lodes canopies ensures that, having started from the standard elements, users can build a personal composition to suit their creative and technical requirements.

I colori, i materiali e le finiture esaltano il carattere versatile ed eclettico del brand. Spaziando dai toni senza tempo a quelli più audaci, le finiture Lodes favoriscono l'interazione e il dialogo tra le lampade, dando espressione a vari mood d'arredo. La varietà della gamma di finiture e la flessibilità offerta dai rosoni Lodes consentono all'utente di partire da elementi standard per personalizzare combinazioni diverse a seconda delle proprie esigenze creative e tecniche.

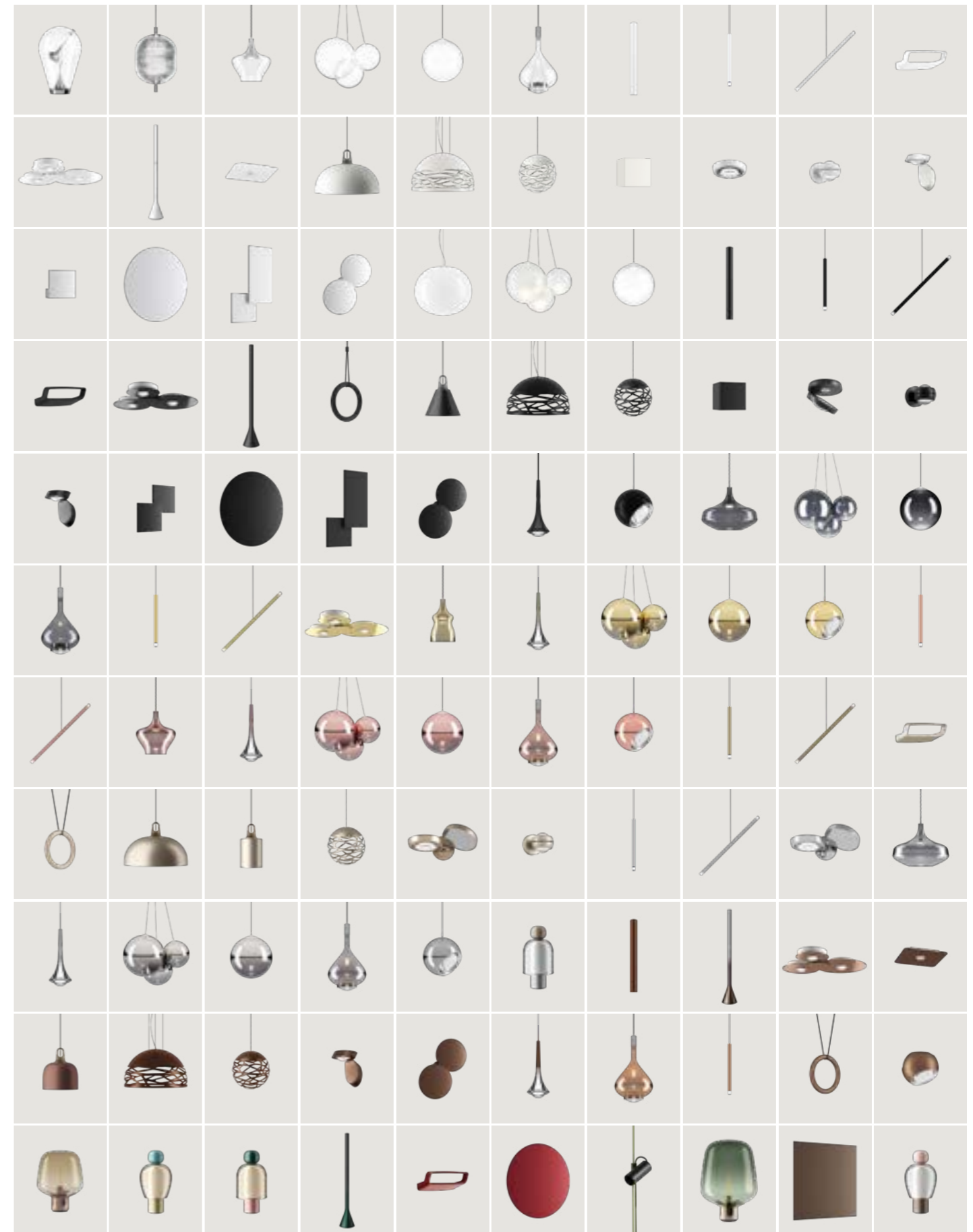

A Foundational

Simple and elegant, the foundation of our colour stories

Semplici ed eleganti, le basi delle nostre storie di colore

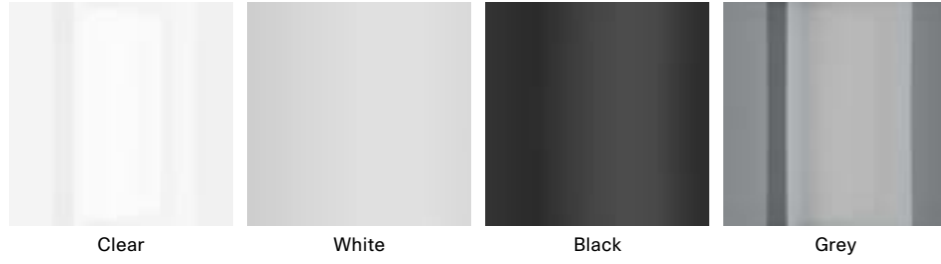

B Precious

A subtle touch of great value

Un sottile tocco di grande valore

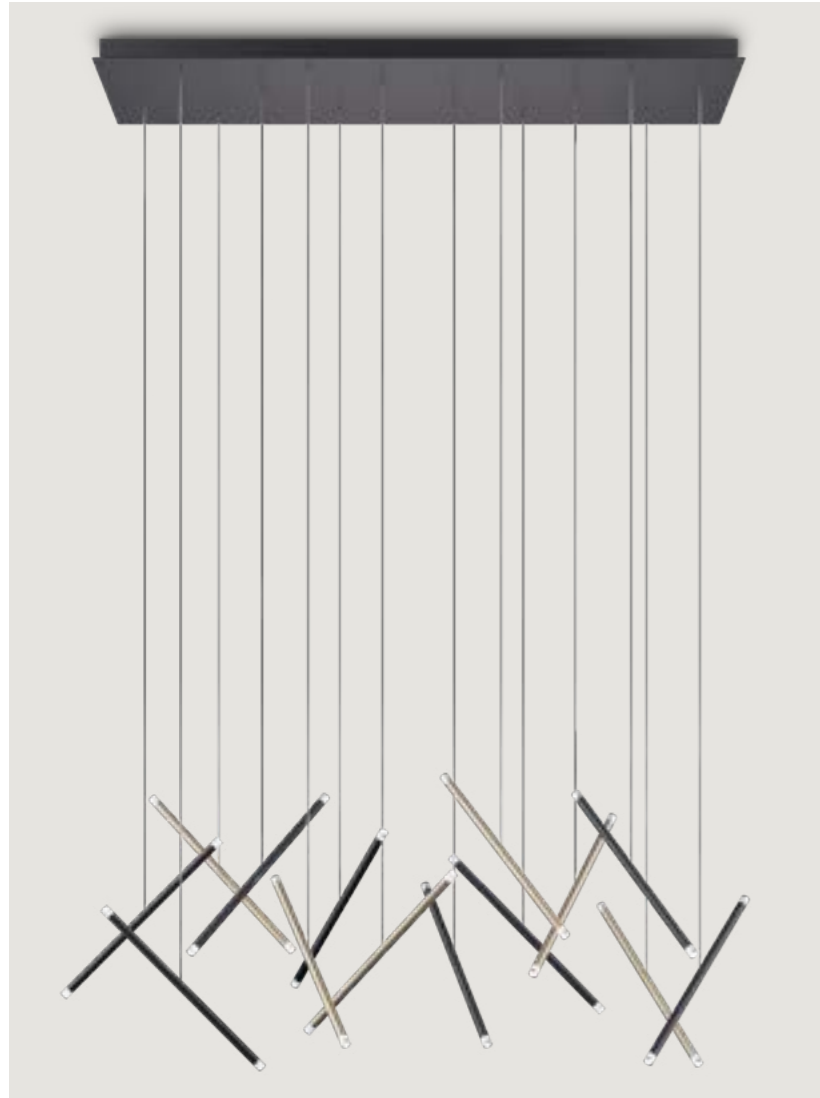

A-Tube Nano Duo ▶ Matte Black and Matte Champagne

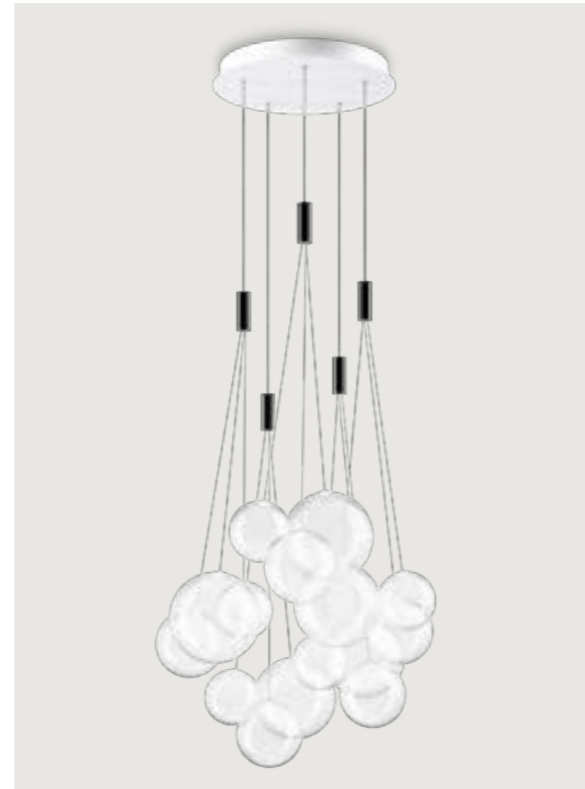

Random ▶ Clear



Rain ▶ Chrome + Gold

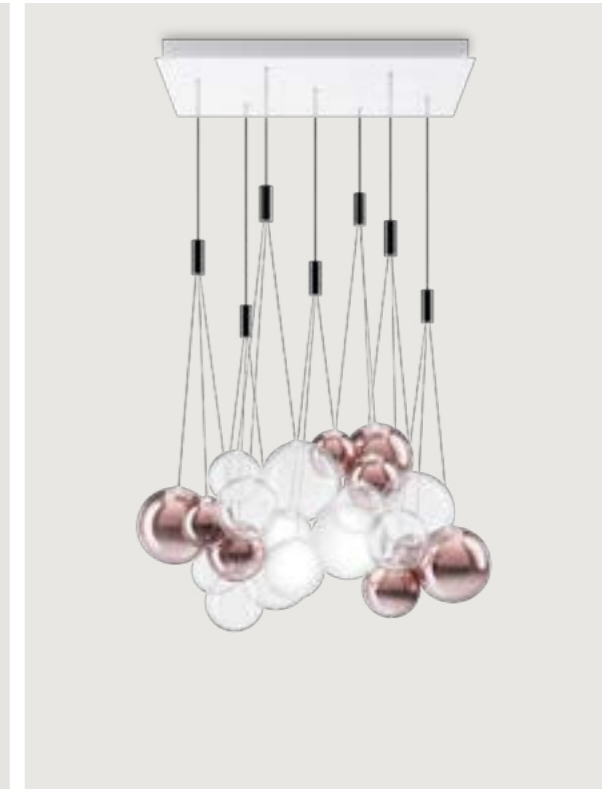

Random ▶ Rose Gold, Frosted White and Clear



Easy Peasy Chestnut ▶ Taupe, Grey and Brushed Palladium

C Warm

Feelings of comfort,
pleasurable experiences

Sensazioni di conforto,
esperienze piacevoli



Bronze

Terra

Honey



A-*Tube Nano* ▶ Terra and Matte Black



JIM bell ▶ Coppery Bronze + Turquoise, Coppery Bronze + Grey
and Coppery Bronze + Honey

D Trend

Powerful colours with a
bold personality

Colori importanti con una
spiccata personalità



Green

Red

Yellow

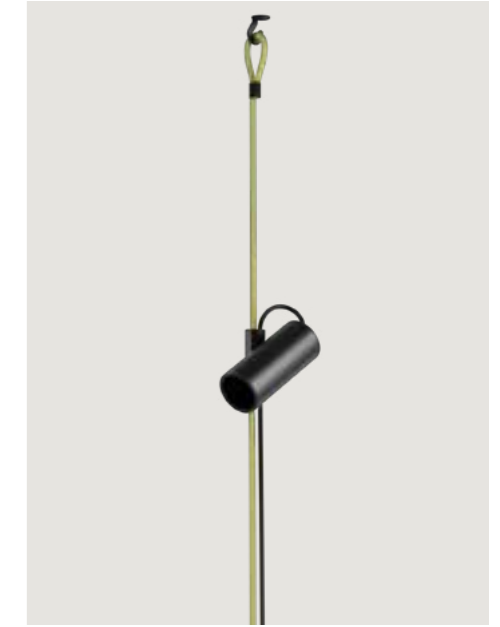

Cima ▶ Yellow + Matte Black

E Pastels, Revisited

Like the precious tesserae of
byzantine mosaics, Lodes' pastels
are veritable accents of energy

Come le preziose tessere dei mosaici
bizantini, i toni pastello di Lodes
sono veri e propri accenti di energia

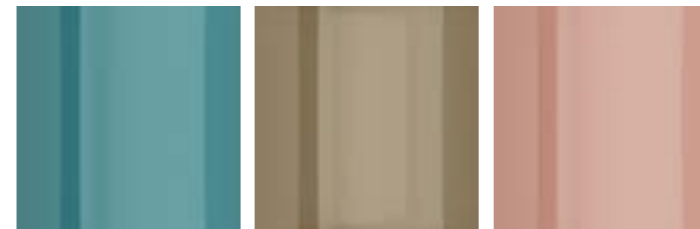

Turquoise

Taupe

Pink

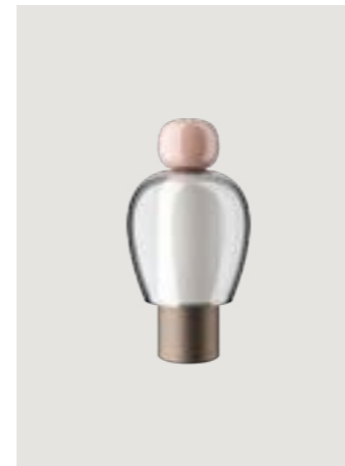

Easy Peasy Flamingo ▶ Pink, Grey and Brushed Bronze

Pag.	Spec sheet	Product name	Category	Year
074	081	A-Tube mini	Ceiling lamp	2013
		small	Cluster suspension lamp, Ceiling lamp	2013
		medium	Cluster suspension lamp, Ceiling lamp	2013
		large	Cluster suspension lamp, Ceiling lamp	2013
046	060	A-Tube Nano small	Cluster suspension lamp	2016
		medium	Cluster suspension lamp	2016
		large	Cluster suspension lamp	2016
064	073	A-Tube Nano Duo	Cluster suspension lamp	2017
304	311	Aile	Wall lamp	2021
260	263	Blow	Table lamp	2005
356	366	Bugia Single	Ceiling lamp	2016
		Double	Ceiling lamp	2016
		Triple	Ceiling lamp	2016
		Mega	Ceiling lamp	2020
278	287	Cima	Suspension lamp, Floor lamp	2021
264	277	Croma	Floor lamp	2021
250	259	Easy Peasy Flamingo	Cordless table lamp	2020
		Lagoon	Cordless table lamp	2020
		Kelp	Cordless table lamp	2020
		Chestnut	Cordless table lamp	2020
240	249	Flar medium	Table lamp, Floor lamp	2022
		large	Table lamp, Floor lamp	2022
386	391	Frozen small	Ceiling lamp	2015
		medium	Ceiling lamp	2015
026	041	IVY I	Cluster suspension lamp	2022
		V	Suspension lamp, Central cluster suspension lamp	2022
204	213	Jefferson mini	Cluster suspension lamp	2019
		small	Cluster suspension lamp	2019
		medium	Cluster suspension lamp	2019
140	154	JIM cylinder	Cluster suspension lamp	2021
		cone	Cluster suspension lamp	2021
		bell	Cluster suspension lamp	2021
		dome	Suspension lamp	2021
124	137	Kelly small dome 50	Suspension lamp	2015
		medium dome 60	Suspension lamp	2015
		large dome 80	Suspension lamp	2015
		small sphere 40	Suspension lamp	2015
		medium sphere 50	Suspension lamp	2015
		large sphere 80	Suspension lamp	2015
		wall	Wall lamp	2015
114	123	Kelly Cluster	Cluster suspension lamp	2015
374	379	Laser 10 x 10	Wall lamp	2015
380	385	Make-Up small	Wall lamp, Ceiling lamp	2015
		medium	Wall lamp, Ceiling lamp	2015
		large	Wall lamp, Ceiling lamp	2015
288	302	Nautilus	Ceiling lamp	2017
		Spot	Ceiling lamp	2020
			Wall lamp	2017
		Mini	Wall lamp	2017
214	226	Nostalgia small	Cluster suspension lamp	2015
		medium	Cluster suspension lamp	2015
		large	Cluster suspension lamp	2015
368	373	Pin-Up	Wall lamp, Ceiling lamp	2015
340	347	Puzzle single square	Wall lamp, Ceiling lamp	2014
		double square	Wall lamp, Ceiling lamp	2014
		square & rectangle	Wall lamp, Ceiling lamp	2014
312	325	Puzzle Mega round small	Wall lamp, Ceiling lamp	2019
		round large	Wall lamp, Ceiling lamp	2019
		square small	Wall lamp, Ceiling lamp	2019
		square large	Wall lamp, Ceiling lamp	2019
348	354	Puzzle Outdoor single square	Wall lamp	2019
		double square	Wall lamp	2019
		square & rectangle	Wall lamp	2019
		round single	Wall lamp	2019
		round double	Wall lamp	2019
328	339	Puzzle Round single	Wall lamp, Ceiling lamp	2016
		double	Wall lamp, Ceiling lamp	2016
084	096	Rain	Cluster suspension lamp	2015
174	185	Random	Cluster suspension lamp	2017
186	201	Random Solo 12	Cluster suspension lamp	2020
		14	Cluster suspension lamp	2020
		18	Cluster suspension lamp	2020
		23	Cluster suspension lamp	2020
		28	Cluster suspension lamp	2020
228	238	Sky-Fall medium	Suspension lamp	2014
		large	Suspension lamp	2014
098	112	Spider	Cluster suspension lamp	2015
		Ceiling	Ceiling lamp	2022
158	171	Volum 14	Cluster suspension lamp	2022
		22	Cluster suspension lamp	2022
		29	Cluster suspension lamp	2022
		42	Suspension lamp	2022

Art. 1 Recital
Unless otherwise provided for in a separate written agreement between the parties, every sale of products of Lodes S.r.l., VAT 02992370276 (hereinafter, "the Seller") is governed by the following General Conditions of Sale that must be considered as an essential part of this agreement and shall be deemed to have been accepted by the Buyer even though the latter has not signed them. Any clause unilaterally added by the Buyer in the documentation signed by it and / or in its correspondence, being against or in any case in addition to the general conditions or to those specific expressly approved in writing by the Seller, shall be deemed as not written and shall be of no effect.

Art. 2 Completion of the sale, quantities and prices
The sale is deemed to be completed once the Seller gives the written order confirmation also by fax and / or email or when deliveries are commenced in cases where the immediate delivery of the supply is requested, also in consideration of changes occurred and then accepted by the customer. The prices agreed are understood for products delivered ex works of the Seller and do not include services and accessory charges (such as VAT, special packaging, transport and installation costs, and/or assemblages and so on).

Art. 3 Delivery, risk transfer and transport
Products are delivered to the Buyer at the Seller's plant or at another place indicated in writing by the Seller, and the risk transfer takes place with the delivery of the goods to the first carrier or Buyer in the events of collection of goods directly carried out by the latter. The products always travel at the Buyer's sole risk also when the carrier is selected and appointed by the Seller, being the latter freed from all responsibilities after having delivered the products to the carrier, this delivery is deemed to all effects being carried out directly by the said Buyer. The delivery terms agreed are to be understood as indicative. If the Seller is responsible for delay of delivery for a period of up to 60 days, the Buyer is not entitled either to refuse the supply or to request the termination of the agreement and / or the compensation for any damages. If the delay in delivery exceeds 60 days, the Buyer is entitled to request - by registered letter - the cancellation of the order and the reimbursement of the advances if paid. In any event, the Seller shall not be liable for and / or direct and indirect damages of any nature and for any reason due to the delay or the failure to carry out the supply.

Art. 4 Reservation of title
The Buyer acquires property rights over the goods with the full payment of the price invoiced of the supplies but it takes the risks thereof as of the delivery.

Art. 5 Products features and conditions of use
Unless otherwise expressly agreed in writing by the parties, the conditions for using of the products are those communicated or in any case resulting from the drawings and technical specifications of the Seller, if any, or as described in the website www.lodes.com/en/in-relation-to-products. The quality levels of products are the standard quality levels of the Sellers, indicated in the relevant specifications as described on the Seller's website. It is always the Buyer's responsibility to identify and notify the Seller of the conditions of use of products before technically defining them. Failing any particular instructions from the Buyer, the Seller considers as usual conditions of use those it considered or described in its designs and technical documentation.

Art. 6 Warranties
The products delivered are covered by a warranty for defects in material and manufacture for a period of 24 months as of the delivery if the Buyer is a natural person, otherwise the warranty period will be of 12 months as of the delivery. The Seller shall replace

the products delivered in this warranty period being faulty due to factory defects or in alternative, at its discretion, pay the Buyer an amount equal to the price already invoiced of the said products, being expressly excluded and waived any other right or claim by the Buyer also as compensation for direct and / or indirect damages or cost repayment borne by it (such as recovery, technical assistance, recalling costs, etc.). The Seller will anticipate the delivery of the replaced product, invoicing it regularly. Successively, when the product arrive to the Seller's warehouse, the latter will credit the amount of the defective product. The transport's costs will be paid by the Seller. Should the defected item be returned in an inadequate non-original packaging, with damages connected to the transport, The Seller will not credit any amount to the Buyer, and it will return the product to the sender at his own expenses. If the replacement was made for alleged defects in material and manufacture, but after the control carried out by the Seller, it is considered

(i) unfounded, due to the absence of defects; (ii) further damaged by insufficient packaging in the return transport (iii) spoiled by tampering made by the Buyer, all transportation costs and the entire value of the product will be charged to the latter. Any defectiveness or non-compliance of products shall be reported by the Buyer by writing to the Seller - in order to be valid - within 8 days from receipt of goods; any hidden defects shall be reported by the Buyer by writing to the Seller - always in order to be valid - within 8 days as of the relevant discovery. It being understood that the Seller will not be responsible for any defect even though hidden, being notified in writing, after 24 months of the delivery of goods. The warranty does not apply where the defects identified are due to the Buyer's negligence and / or to the use of products being not compliant with the information and explanations in any case gave by the Seller, technical provisions, to incorrect design, application, assembly or manufacture of the facilities in which they are installed, to incorrect maintenance carried out by unauthorized personnel, to improper cleaning since it is made with materials and manners being not suitable, to incorrect storage, handling and transport, to improper or imprudent use, also in the event of electrical system and its capacity being not suitable, or to circumstances that in any case cannot be related to the production defectiveness by the Seller. Every single product of the Seller corresponds to the mark laid down by the European Community with Directive 93 / 68 (extension of Directive 73 / 23) to confirm, with a mark recognized all over Europe, that the lights have undergone the electrical safety test required by European standards EN-60598-1-2 II ed. + CEI EN 60598-1 IV ed. corresponding to Italian standards CEI 34-21 + CEI 34-23, electrical safety standards referred to by all institutions, including the IMQ. The products indicated with the logo UL and / or ETL corresponds to the standards UL 1598 / CAN / USA C22.2 No.250.0 o UL 153.

Art. 7 Buyer's Obligations
The Buyer is required to immediately take delivery of the goods given by the Seller to the carrier, or - where otherwise agreed - to timely collect them at the Seller's plant on the date on which the Seller communicates, by any means, that the goods are ready. Where the Buyer delays the collection of the production for a period exceeding 10 days, in addition to the payment of price it shall pay the Seller a proper compensation equal to 2% per day of the price invoiced for storing such products. The Buyer shall carry out the payments normally, in accordance with the terms and conditions specified in the invoice. For late payments it will be accrued by default without need of further notification interest under Legislative Decree no. 231 / 2002. In the event of payment delays, the Seller is entitled to immediately suspend any supply, even though it has concluded other agreements with the same Buyer. The failure to pay within the terms agreed will cause in any event the loss of favourable terms for the Buyer.

Art. 8 Replacement of the Product
If a product is returned for commercial reasons or for a mistake in the order made by the Buyer, the Seller will retain an amount equal to the 20% of the total price as cost for reconditioning the product. If the returned product had already been used and / or it has been returned in an inadequate original packaging, with consequent transport damages, the Seller will not credit to the Buyer any amount and it will return the product to the sender at his own expenses. Only the articles in the catalogue and in the price list in force at the time of the request will be taken into consideration. Transport's costs are always charged to the Buyer. The repair of damaged products will be authorized only if the damage has been caused by the Buyer. The Buyer, once accepted repair costs, will take care of returning the damaged product to the Seller's warehouse and it will pay the costs of transporting the repaired product.

Art. 9 Force majeure
If the Seller is unable to comply with the agreement due to force majeure or beyond its control events, the deadlines set for the supply are automatically extended for a period in which these effects continue. Where the obstacle to comply with the agreement is longer than 6 months, both parties may request the termination of the agreement and, in such event, the Seller repay the Buyer the advances received, if any, releasing itself from any additional obligation on it.

Art. 10 Agreement
In the event of execution of a specific agreement signed by the parties, the said agreement together with its Annexes provides for and summarizes the obligations validly undertaken by the parties and being binding for them. The fulfilment by the parties will be subject to effective evaluation of the actual performance of the contractual tasks and duties to be carried out in good faith, with honesty and fairness. These General Conditions of Sale shall apply to the agreement, unless otherwise provided in writing by the parties or expressly provided in the said agreement.

Art. 11 Privacy Policy
The Seller will use the data received from the Buyer in accordance with the provisions of the article 13 of EU Regulation 2016 / 679 of 27 April 2016 (GDPR). For more information are available at the following link: www.lodes.com/en/terms-and-conditions/.

Art. 12 Disputes
Any dispute which may arise concerning the signing, validity, interpretation, performance, amendment and termination of the agreement or of these General Conditions of Sale will be settled according to principles and rule set forth in Article 13 below.

Art. 13 Jurisdiction and Applicable Law
The Court of Milan, Italy, shall be held exclusively competent, being any other court of competent jurisdiction expressly excluded, and the Italian Law shall be applicable.

Art. 14 Website
These General Conditions of Sale are those indicated on the website www.lodes.com/en/ and may be printed and reproduced on paper. The Seller undertakes to update the website www.lodes.com/en/ by publishing on it the version of the General Conditions of Sale as amended from time to time.

Art. 1 Premessa
Salvo deroga risultante da apposito accordo scritto tra le parti, ogni compravendita di prodotti di Lodes S.r.l., P.IVA 02992370276 (di seguito: "Venditore") è regolata dalle seguenti Condizioni Generali di Vendita che costituiscono parte essenziale del contratto e che si intendono pertanto accettate dal Compratore ancorché dallo stesso non sottoscritte. Qualsiasi clausola unilateralmente apposta dal Compratore nei documenti da lui sottoscritti e / o nella sua corrispondenza, che sia contraria o comunque in aggiunta alle seguenti condizioni generali od a quelle speciali espressamente approvate per iscritto dal Venditore, si intende come non scritta ed è priva di ogni effetto.

Art. 2 Perfezionamento della compravendita, quantitativi e prezzi
La compravendita si intende perfezionata con la conferma d'ordine scritta del Venditore anche a mezzo fax e / o posta elettronica o con l'inizio delle consegne per i casi in cui è stata richiesta l'immediata consegna della fornitura anche in presenza di modifiche intervenute e quindi accettate dal cliente. I prezzi concordati si intendono per prodotti consegnati franco stabilimento del Venditore e non comprendono prestazioni ed oneri accessori (quali IVA, imballo speciale, spese di trasporto, di installazione e / o montaggi e così via).

Art. 3 Consegna, trasferimento del rischio e trasporto
La merce viene consegnata al Compratore presso lo stabilimento del Venditore o in altro sito dallo stesso indicato per iscritto, ed il trasferimento del rischio avviene con la consegna della stessa al primo vettore o al Compratore nelle ipotesi di ritiro della merce da quest'ultimo direttamente eseguita. La merce viaggia sempre a rischio esclusivo del Compratore anche quando il vettore dovesse essere scelto ed incaricato dal Venditore, essendo quest'ultimo liberato da ogni responsabilità con la consegna dei prodotti al vettore, che ad ogni effetto si intende eseguita a mani dallo stesso Compratore. I termini di consegna pattuiti si intendono indicativi. In caso di ritardo nella consegna imputabile al Venditore per un periodo fino a 60 gg il Compratore non ha il diritto di rifiutare la fornitura, né di richiedere la risoluzione del contratto e / o il risarcimento di alcun danno. Se il ritardo nella consegna supera il termine di 60 gg il Compratore ha la facoltà di richiedere - con lettera raccomandata - l'annullamento dell'ordine e la restituzione degli anticipi eventualmente versati. Resta in ogni caso escluso qualsivoglia obbligo del Venditore di risarcimento danni diretti e / o indiretti di qualsiasi natura e per qualsiasi ragione, in dipendenza del ritardo ovvero della mancata esecuzione della fornitura.

Art. 4 Riserva di proprietà
Il Compratore acquista la proprietà della merce solo con il pagamento integrale del prezzo fatturato delle forniture ma ne assume i rischi dal momento della consegna.

Art. 5 Caratteristiche dei prodotti e condizioni di utilizzo
Salvo diverso ed espresso accordo scritto tra le parti, i parametri funzionali dei prodotti sono quelli espressi comunicati o comunque risultanti nei disegni e specifiche tecniche del Venditore se esistenti o su quanto indicato sul sito web www.lodes.com relativamente ai prodotti. I livelli di qualità dei prodotti forniti sono quelli standard del Venditore, evidenziati nelle relative specifiche o su quanto indicato e desumibile sul sito web del Venditore. È onere del Compratore individuare e comunicare al Venditore le condizioni di utilizzo dei prodotti prima della relativa definizione tecnica. In mancanza di indicazioni da parte del Compratore il Venditore considera condizioni di utilizzo quelle di prassi dallo stesso considerate o esplicitate nei propri disegni e documentazione tecnica.

Art. 6 Garanzie
I prodotti forniti sono coperti da garanzia per difetti di materiale e / o fabbricazione per un periodo di 24 mesi dalla consegna se il Compratore risulta essere una persona fisica, diversamente il periodo di garanzia sarà di 12 mesi dalla consegna. Il Venditore sostituisce i prodotti resi in detto periodo di garanzia e riconosciuti difettosi per vizi d'origine ovvero in alternativa ed a sua scelta accreditata al Compratore una somma pari al prezzo già fatturato dei prodotti stessi, restando espressamente escluso e rinunciato qualsiasi diverso diritto o pretesa del Compratore anche a titolo di risarcimento danni diretti e / o indiretti o di rimborso di costi dallo stesso sostenuti (quali costo di riprese, di assistenza tecnica, di richiamo, ecc.). Il Venditore anticiperà l'invio del prodotto in sostituzione, fatturandolo regolarmente, andando poi ad accreditare l'importo alla riconsegna del prodotto difettoso reso. Le spese di trasporto saranno a carico del Venditore. Qualora l'articolo oggetto del reso venisse riconsegnato in un imballo non originale inadeguato con conseguenti danni da trasporto, il Venditore non accrediterà al Compratore alcun importo e rinverrà al mittente, a sue spese il prodotto. Qualora il reso venisse effettuato per presunti vizi d'origine ma dopo il controllo effettuato dal Venditore lo stesso venisse ritenuto (i) infondato, per assenza di vizi; (ii) ulteriormente danneggiato da insufficiente imballaggio nel trasporto di ritorno (iii) viziato da manomissione posta in essere dal Compratore, verranno addebitati a quest'ultimo tutti i costi di trasporto nonché l'intero valore del prodotto. Eventuali difettosità o non conformità dei prodotti devono essere segnalate dal Compratore per iscritto al Venditore - a pena di decadenza - entro e non oltre 8 gg dalla data di ricevimento della merce; eventuali difetti occulti devono essere segnalati dal Compratore per iscritto al Venditore - sempre a pena di decadenza - entro 8 gg dalla relativa scoperta. Resta inteso che il Venditore non sarà responsabile per alcun vizio ancorché occulto, comunicato per iscritto, oltre 24 mesi dalla consegna della merce. La garanzia non opera ove i difetti rilevati siano imputabili a negligenza del Compratore e / o ad impiego dei prodotti non conforme con le informazioni e le spiegazioni in ogni caso fornite dal Venditore, alle prescrizioni tecniche, ad errata progettazione, applicazione, montaggio o fabbricazione delle strutture ove sono installati, ad errata manutenzione operata da personale non autorizzato, a pulizia impropria in quanto effettuata con modalità o materiali non idonei, ad errato magazzinaggio, movimentazione e trasporto, ad uso improprio od incauto, anche in caso di impianto elettrico e portata dello stesso non idonea, ovvero a circostanze che comunque non possono ricollegarsi a difettosità di produzione da parte del Venditore. Ogni singolo prodotto del Venditore è conforme alla marcatura richiesta dalla Comunità Europea con la direttiva 93 / 68 (ampliamento della direttiva 73 / 23) per confermare con una marcatura riconosciuta in tutta Europa, che le lampade sono state sottoposte alle prove di sicurezza elettrica richieste dalle norme Europee EN-60598-1-2 II ed. + CEI EN 60598-1 IV ed. corrispondenti norme italiane CEI 34-21 + CEI 34-23, norme per la sicurezza elettrica a cui fanno riferimento tutti gli istituti, compreso l'IMQ. I prodotti indicati con il marchio UL e / o ETL sono conformi alla normativa UL 1598 / CAN / USA C22.2 No.250.0 o UL 153.

Art. 7 Obblighi del Compratore
Il Compratore è tenuto a prendere immediatamente in consegna i prodotti affidati dal Venditore al vettore, ovvero - se diversamente concordato - a puntualmente ritirarli presso lo stabilimento del Venditore alla data di comunicazione di merce pronta che potrà avvenire con ogni mezzo da parte del Venditore. Ove il Compratore ritardi il ritiro dei prodotti per un periodo superiore a 10 gg, oltre al pagamento del prezzo deve corrispondere al Venditore un adeguato compenso pari al 2% al giorno dell'importo fatturato per il magazzinaggio degli stessi. Il Compratore deve effettuare i pagamenti normalmente, con le modalità e nei termini precisati in fattura. Sui ritardati pagamenti decorreranno, di pieno diritto e senza necessità di costituzione in mora, gli

interessi di cui al D.lgs. n. 231 / 2002. In caso di ritardo dei pagamenti il Venditore ha diritto a sospendere immediatamente ogni fornitura, anche se dipendente da altri contratti con lo stesso Compratore. Il mancato pagamento nei termini pattuiti comporta in ogni caso la decadenza del Compratore dal beneficio del termine.

Art. 8 Resi
In caso di reso commerciale o in caso di reso per errore del Compratore, il Venditore tratterà un importo pari al 20% minimo del totale a titolo di costo di ricondizionamento dell'articolo. Qualora l'articolo oggetto del reso fosse già stato utilizzato e / o venisse riconsegnato in un imballo non originale inadeguato, con conseguenti danni da trasporto, il Venditore non accrediterà al Compratore nessun importo e rinverrà al mittente, a sue spese, il reso. Verranno presi in considerazione solamente gli articoli presenti nel catalogo e nel listino in vigore al momento della richiesta. Le spese di trasporto sono sempre a carico del Compratore. I resi per riparazione vanno autorizzati solo se la causa del danno è dipesa dal Compratore che dopo aver accettato il costo di riparazione si occuperà a proprie spese di rispedire l'articolo danneggiato in sede e si accollerà poi i costi relativi al trasporto del prodotto riparato.

Art. 9 Forza maggiore
Qualora il Venditore sia impossibilitato a rispettare il contratto per cause di forza maggiore o comunque indipendenti dalla sua volontà, i termini previsti per l'esecuzione della fornitura sono automaticamente prorogati per un periodo equivalente al perdurare degli effetti di tali cause. Qualora la causa impeditiva continui per più di 6 mesi entrambe le parti possono chiedere la risoluzione del contratto ed in tal caso il Venditore restituisce al Compratore gli anticipi eventualmente ricevuti, con esclusione di ogni e qualsiasi onere ulteriore a suo carico.

Art. 10 Contratto
In caso di sottoscrizione di apposito contratto lo stesso con i suoi allegati contiene e riassume le obbligazioni validamente assunte dalle parti e per esse vincolanti. L'adempimento delle parti sarà oggetto di valutazione dell'effettiva esecuzione dei compiti e doveri contrattuali, da effettuarsi in buona fede, onestà e con equità. Le presenti Condizioni Generali di Vendita si applicheranno al contratto salvo deroga risultante da atto scritto o in esso contratto esplicitamente prevista.

Art. 11 Trattamento dei Dati Personali
Il Venditore utilizzerà i dati ricevuti dal Compratore conformemente alle disposizioni vigenti in materia di Privacy secondo l'art. 13 del Regolamento Europeo 2016 / 679 (GDPR). Maggiori informazioni sono disponibili al seguente link: www.lodes.com/area-legale/.

Art. 12 Controversie
Qualora dovesse verificarsi una qualsivoglia controversia avente ad oggetto la formazione, validità, interpretazione, esecuzione, modifica e risoluzione del contratto o delle presenti Condizioni Generali di Vendita, questa sarà risolta secondo i principi e le regole indicate nell'articolo 13 che segue.

Art. 13 Foro competente e legge applicabile
Foro esclusivamente competente sarà quello di Milano con esplicita esclusione di ogni altro foro alternativamente competente, e la legge applicabile quella italiana.

Art. 14 Sito Web
Le presenti Condizioni Generali di Vendita, sono quelle risultanti sul sito web www.lodes.com e sono stampabili e riproducibili su supporto cartaceo. Il Venditore si impegna ad aggiornare il sito web www.lodes.com mediante la pubblicazione sullo stesso della versione di Condizioni Generali di Vendita di volta in volta modificata.

Head offices & showroom

Lodes, via Pialoi 32,
30020 Marcon (Venezia) Italy
T +39 041 45 69 266

General information
info@lodes.com

Lodes 2022
Collection Catalogue

*Art direction
and graphic design*
Think Work Observe

Images
Bruger Studio

Photography
Mattia Balsamini
(pag. 002–009)
Studio Pointer

Copywritings
Lodes

*Colour separation
and printing*
O.G.M.

Showrooms

Lodes Paris
Novaluce S.a.r.l.
131 Rue du Faubourg
Saint-Honoré
75008 Parigi, Francia
T. +33 142 890 318
paris@lodes.com

Lodes Doha
Abensal Lighting
C-Ring Road, St. 230
Zone 41, Building no. 245
Al Hilal – Doha, Qatar
T. +974 4016 4866
qatar@abensal.com

Vertegenwoordiging voor NL :

ilu design b.v.
nijverheidsweg 9a
6691 EZ gendt
tel 0481 433 800

info@iludesign.com
www.iludesign.com

